

*After School Builders*  
**GRANT LIBRARY**

*designed by*  
Todd Merrifield

National  
Library Week



PDF & Video Instructions at:  
[www.happyakrz.com](http://www.happyakrz.com)

**1,955 Pieces**

**HappyAkz**  
by Oikodómos, LLC



1

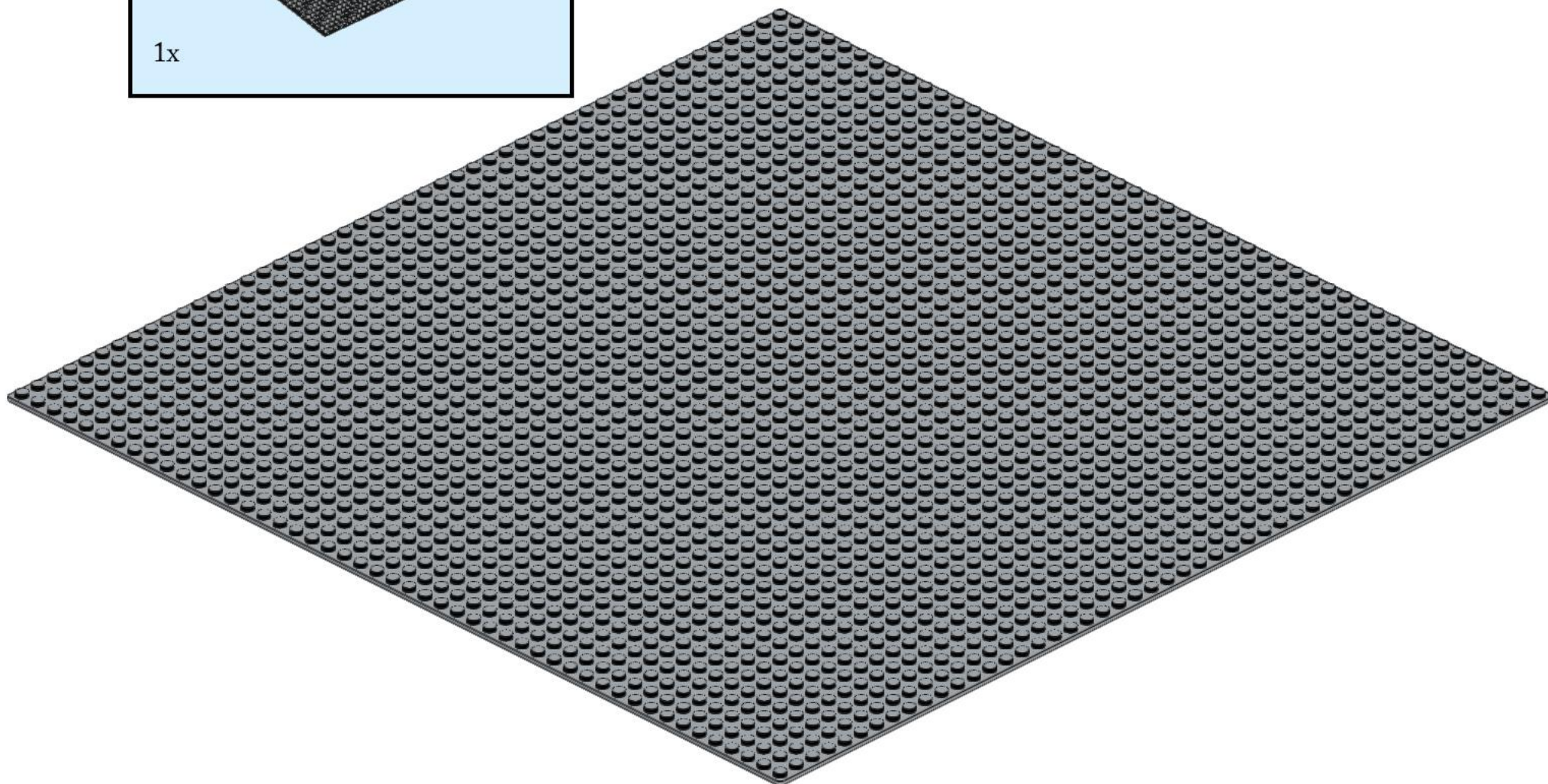
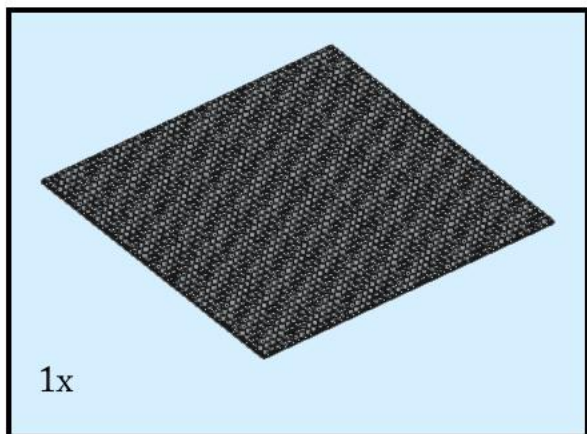

2

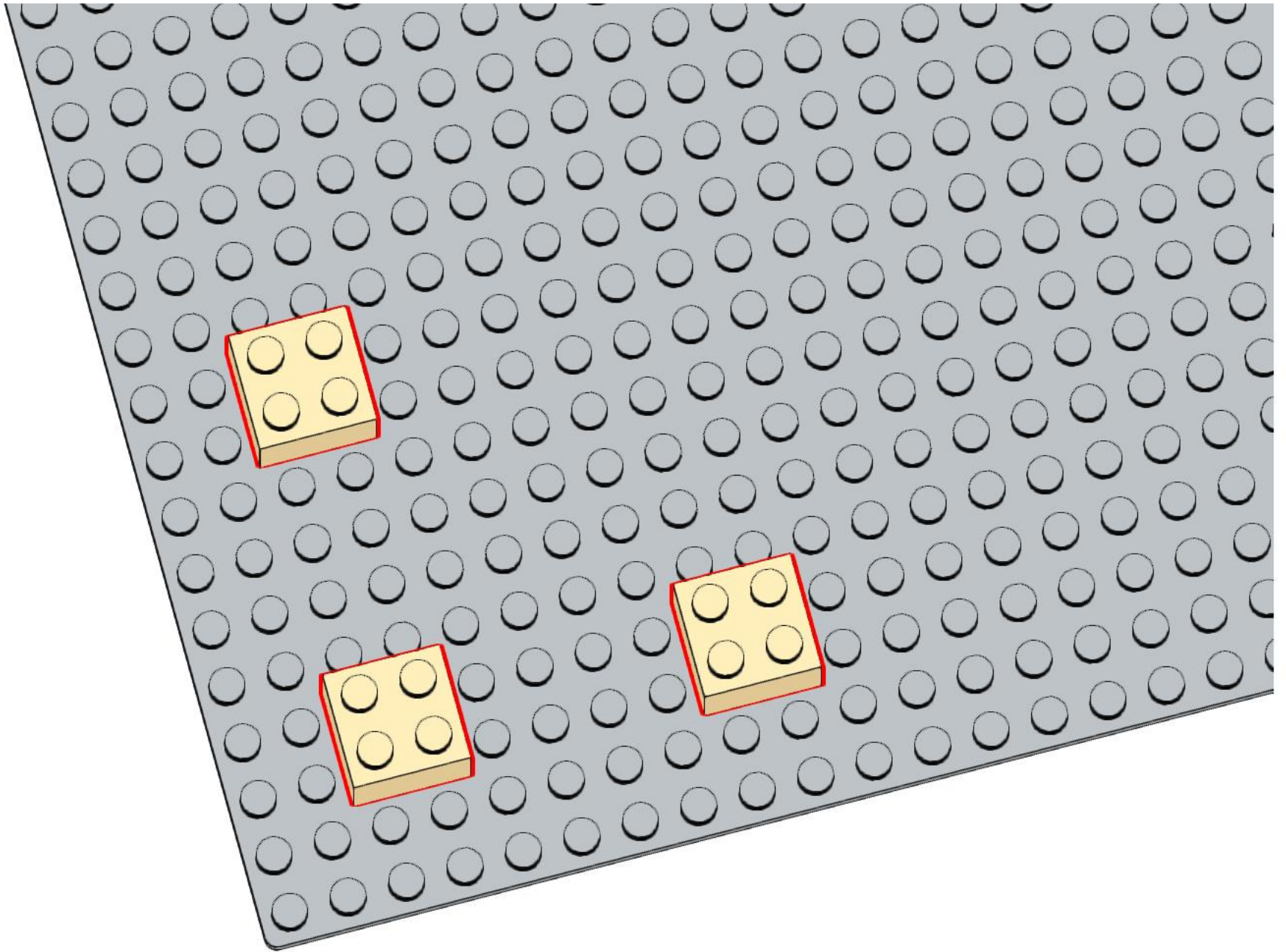
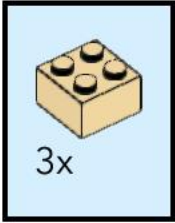

# 3

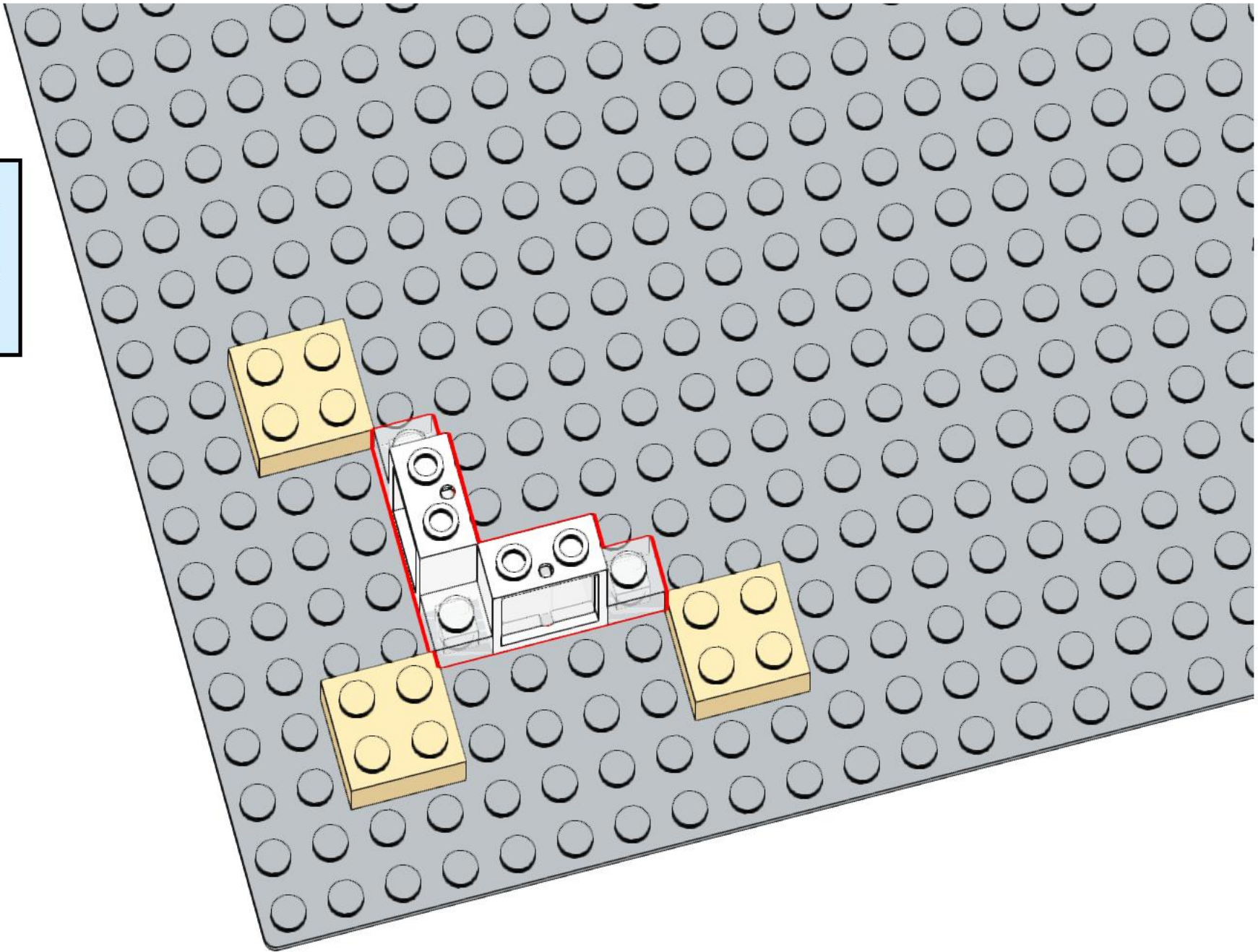
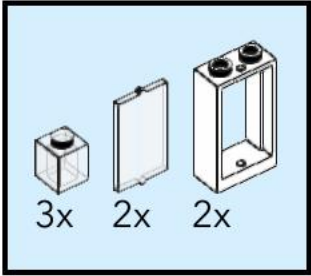

4

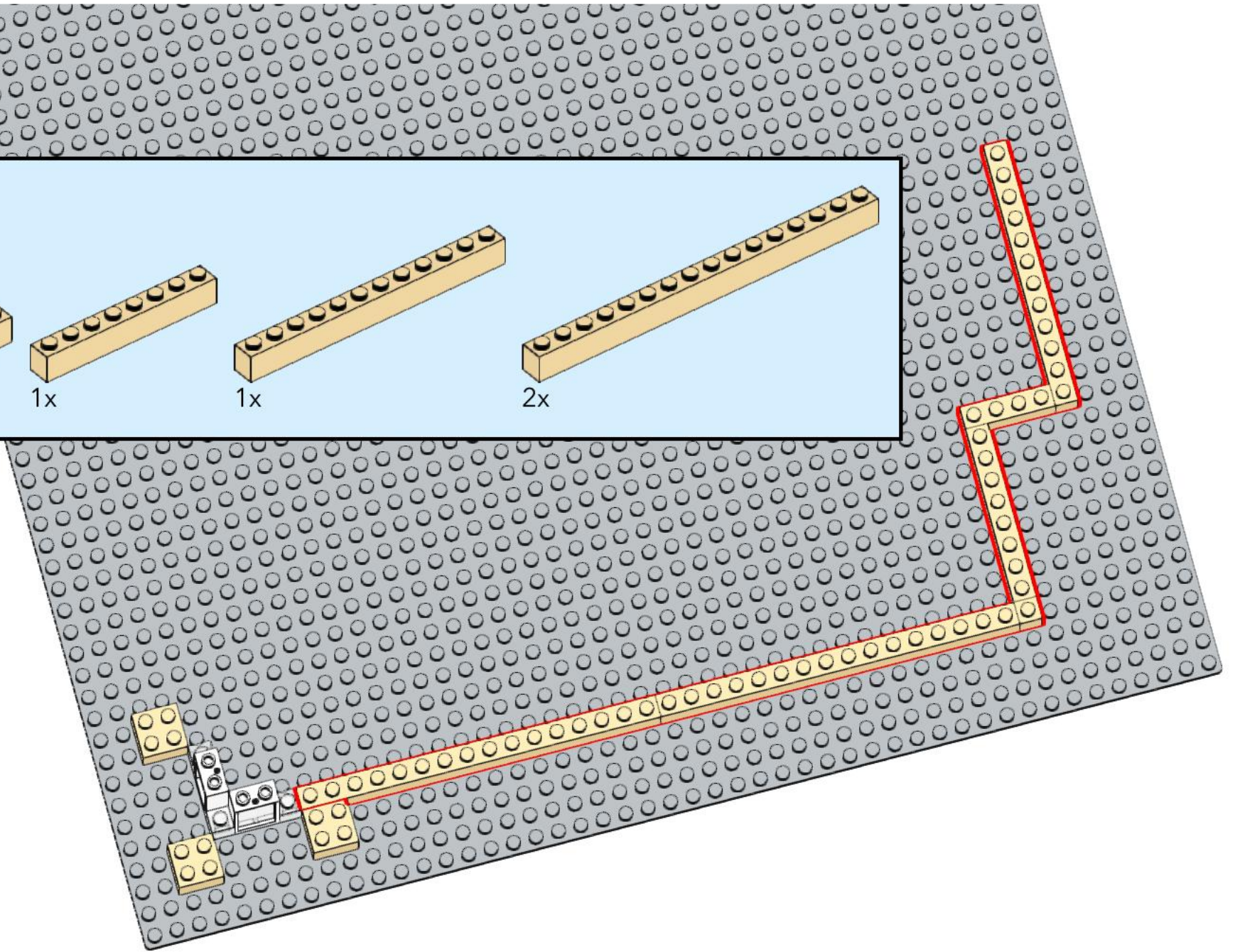
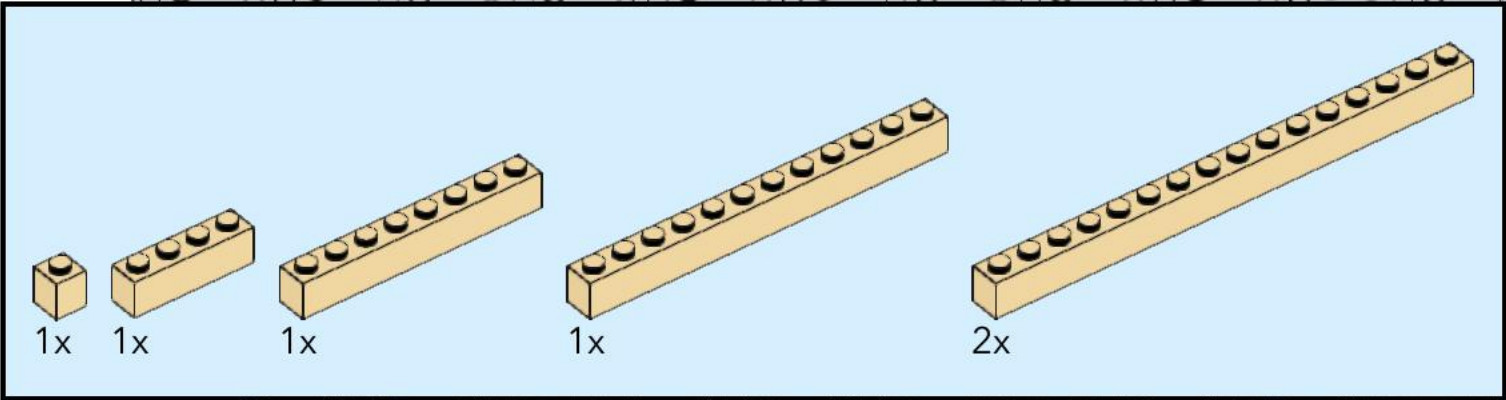

5

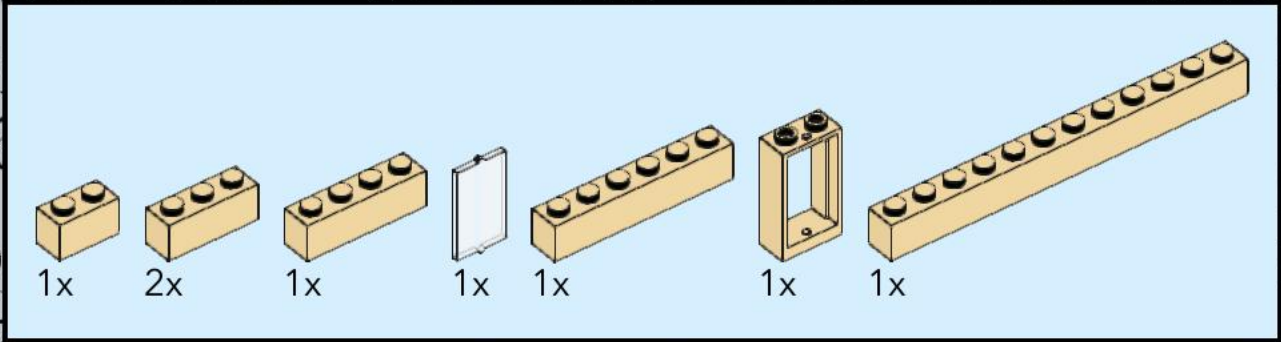
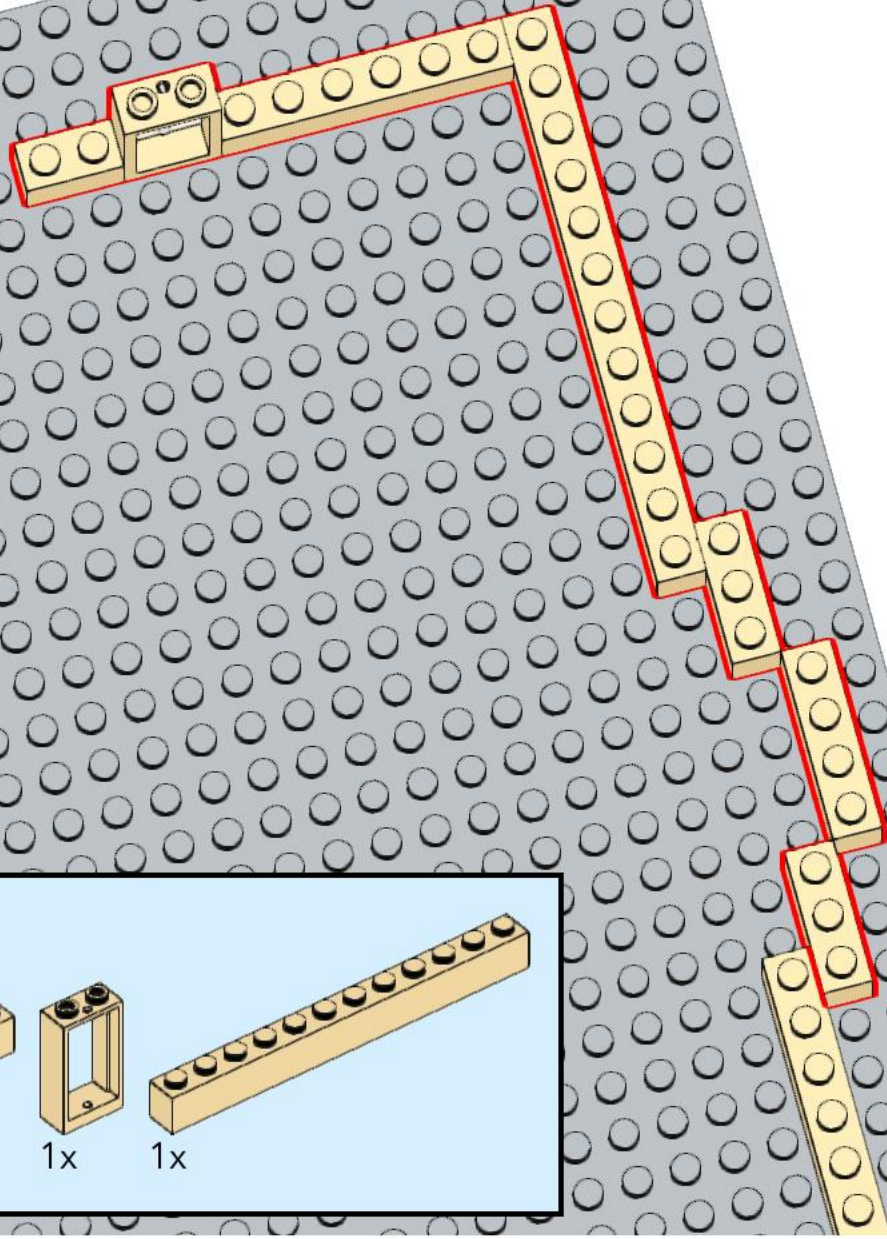

6

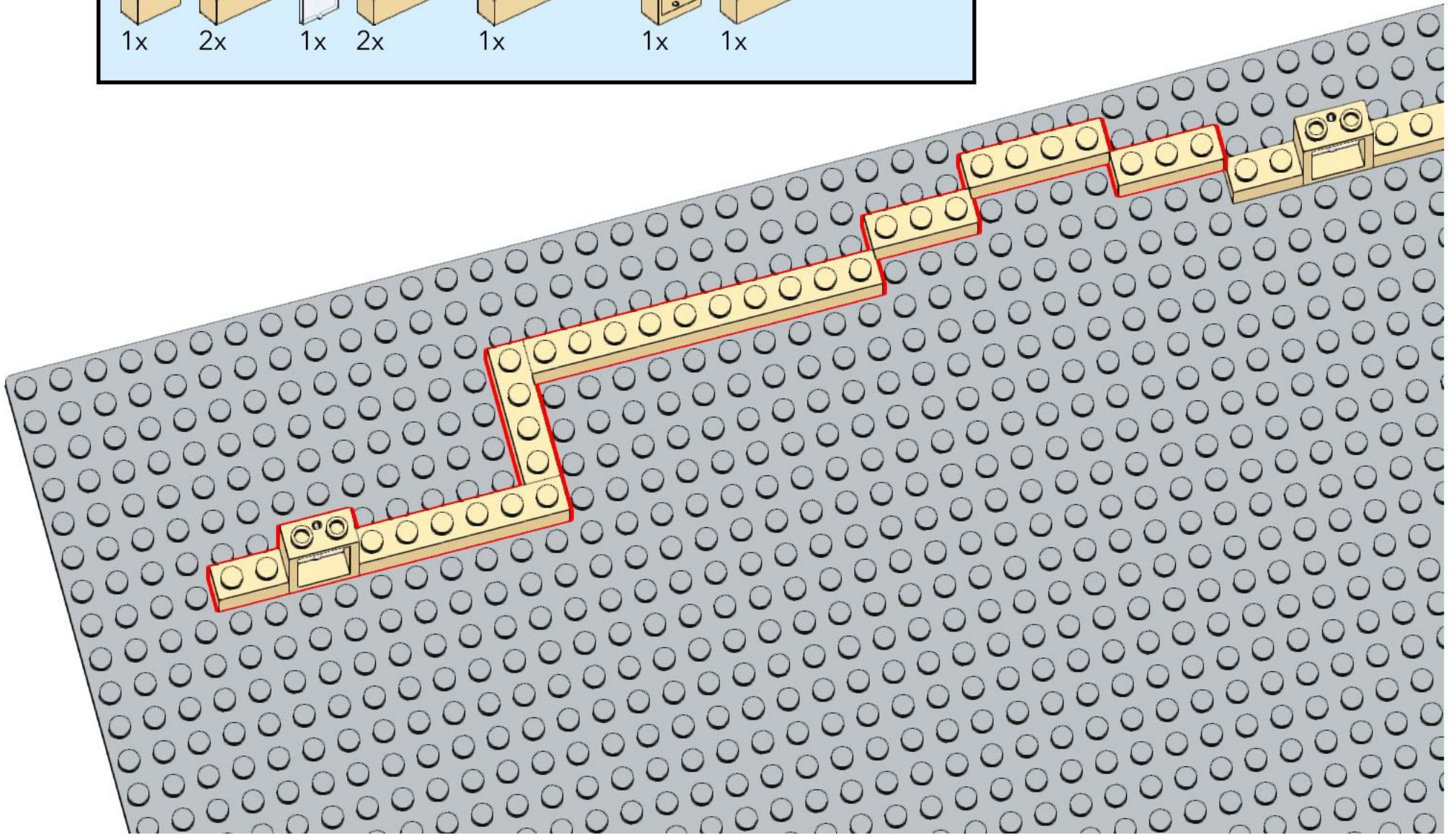
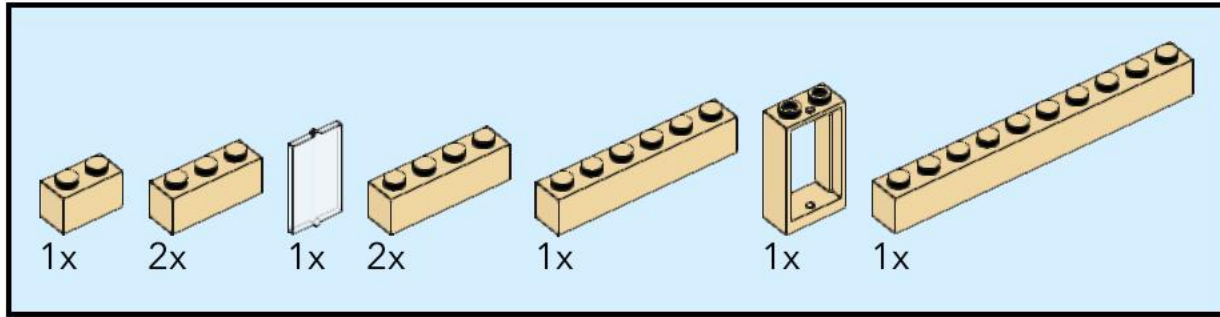

7

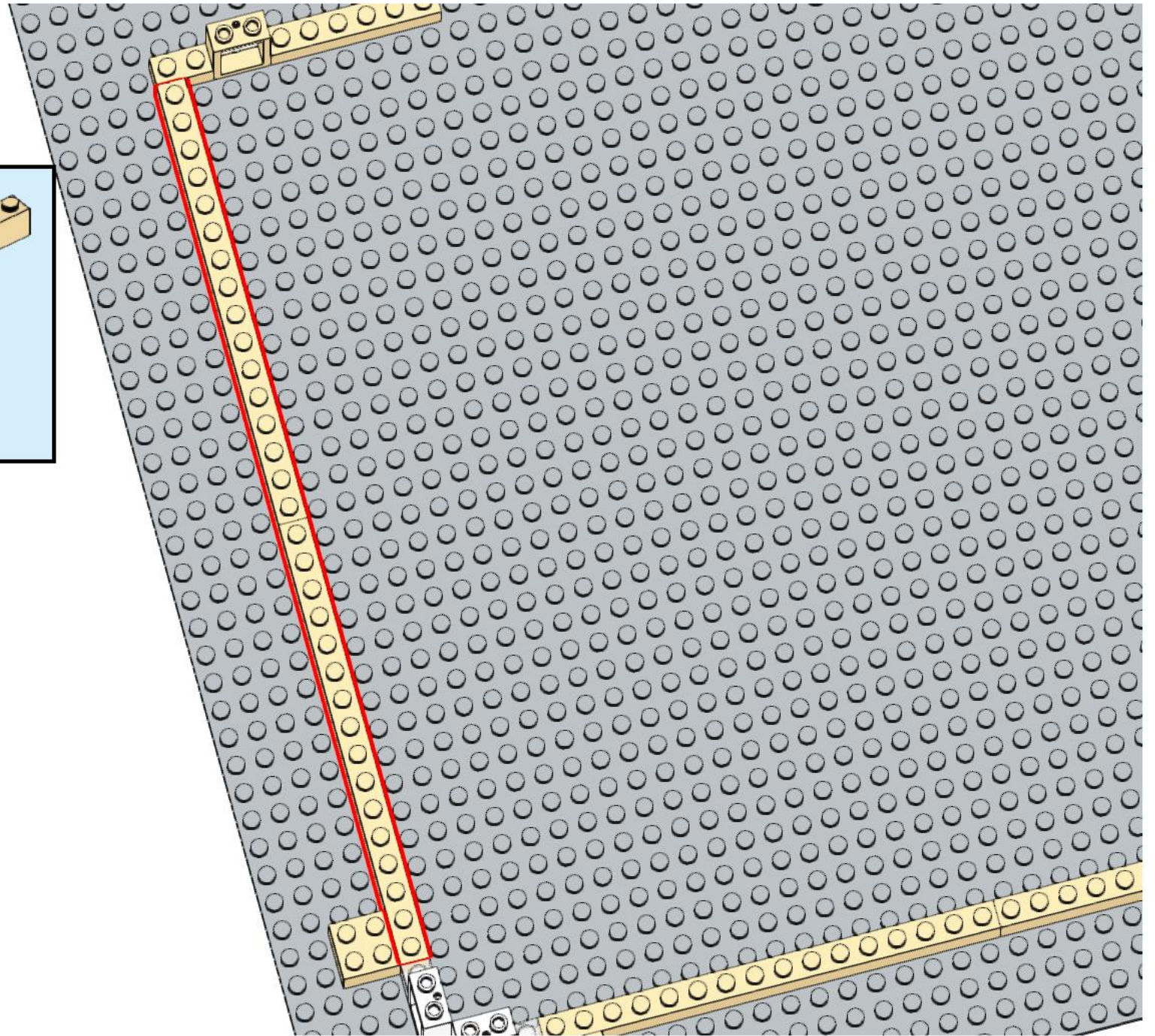
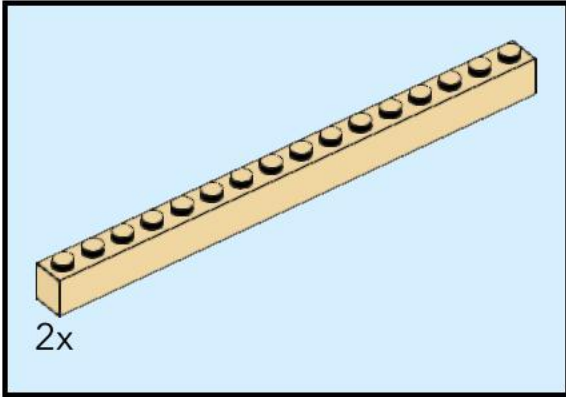



8

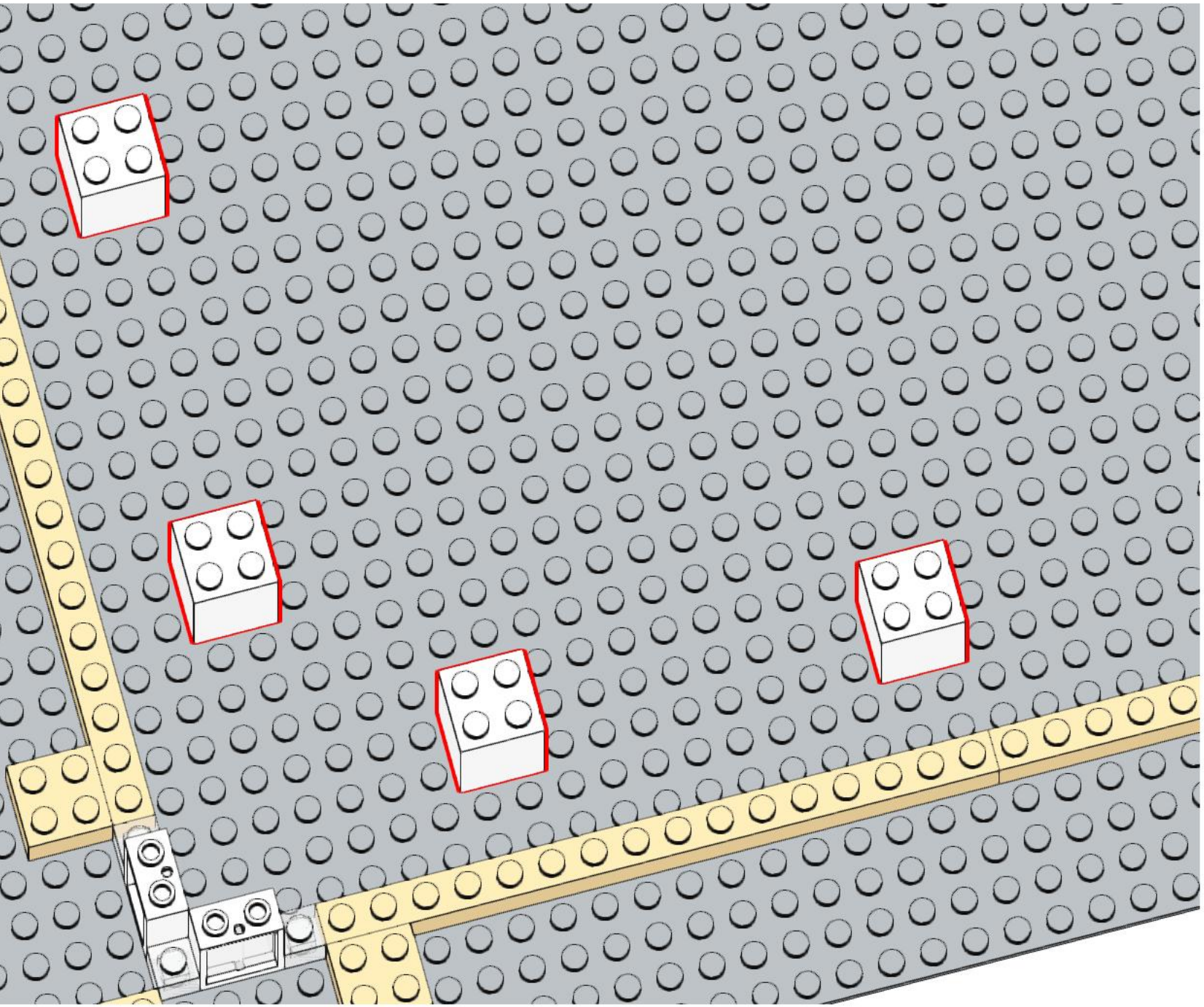
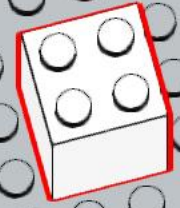
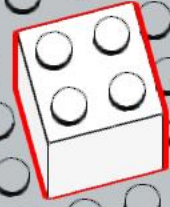
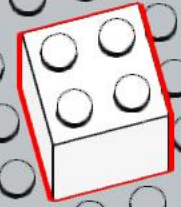
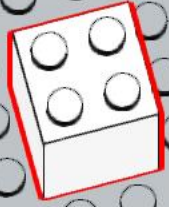
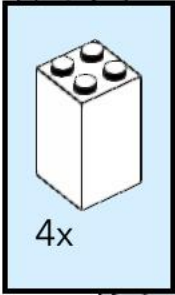

9

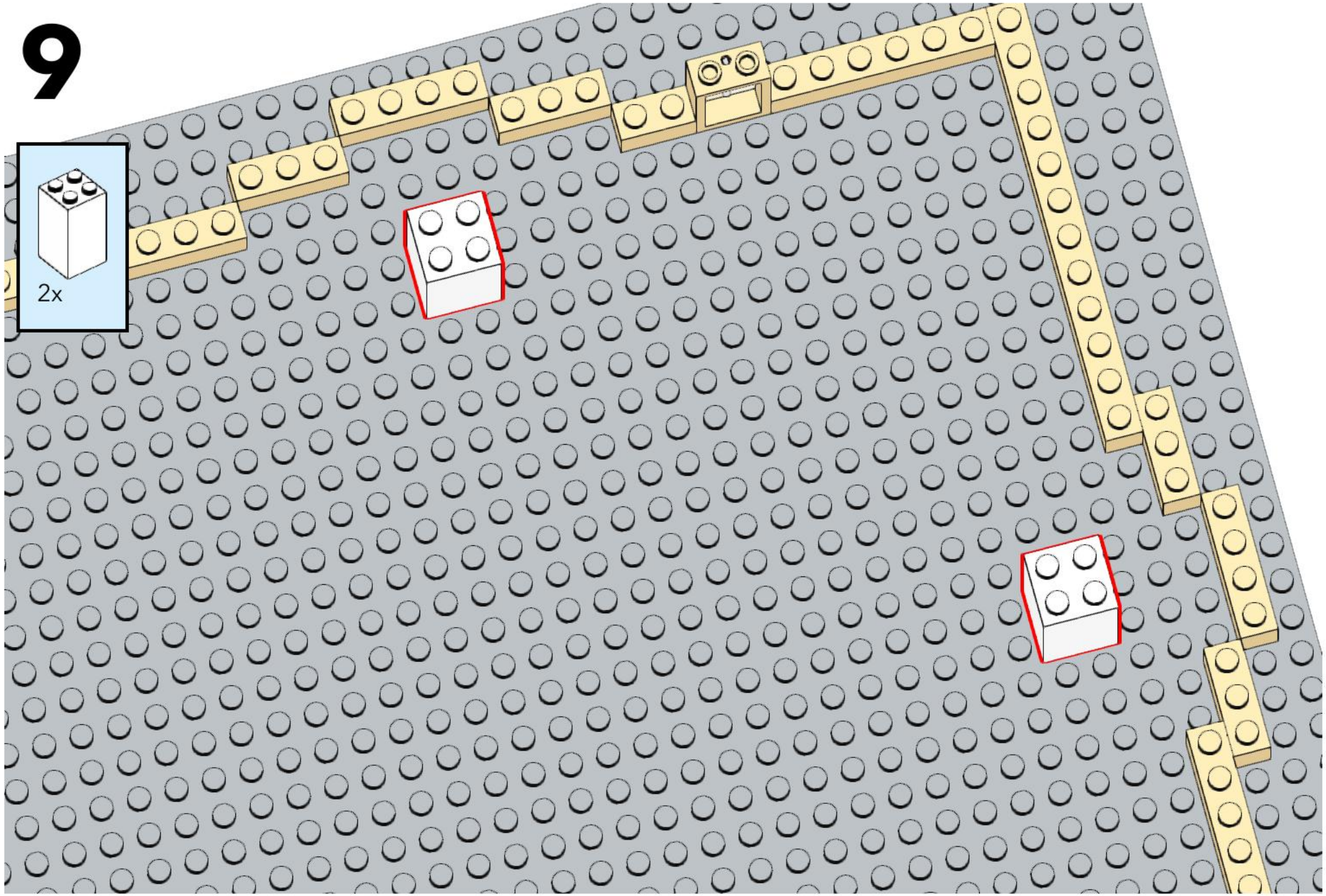
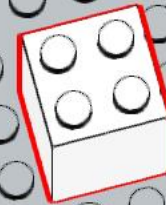
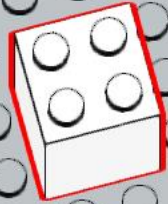
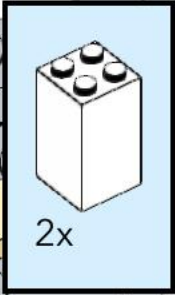

# 10

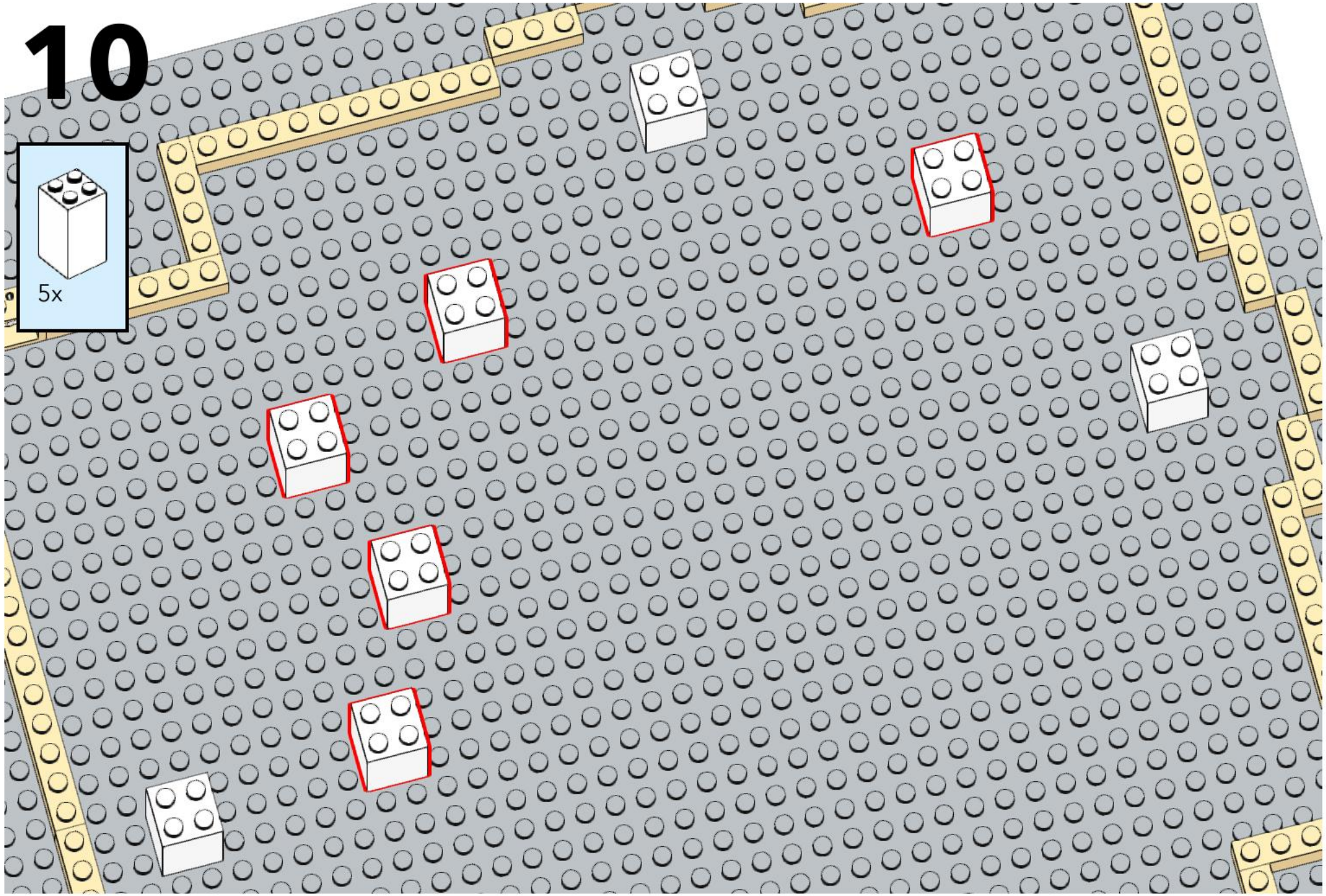
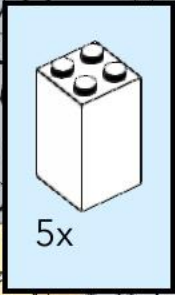

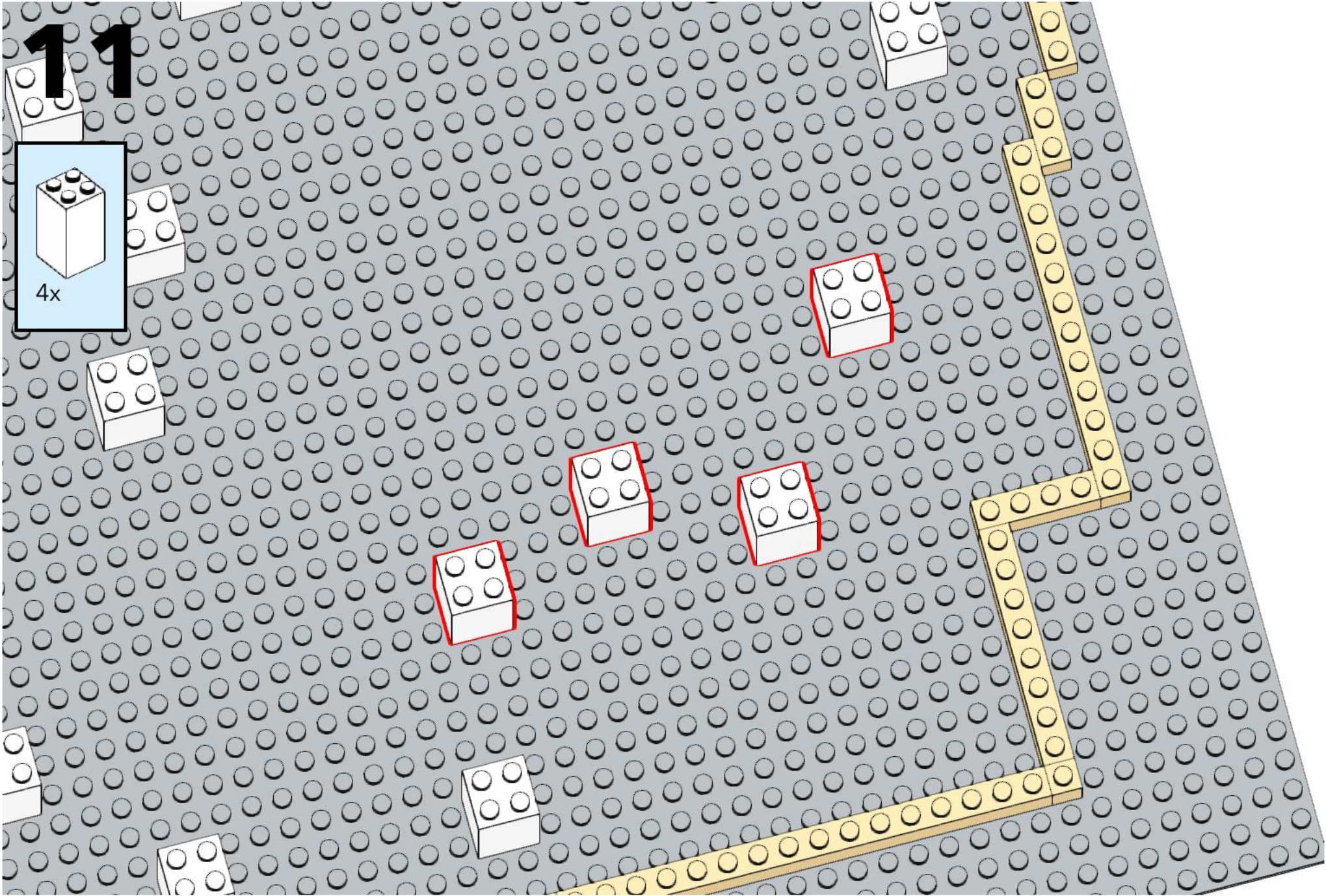

# 12

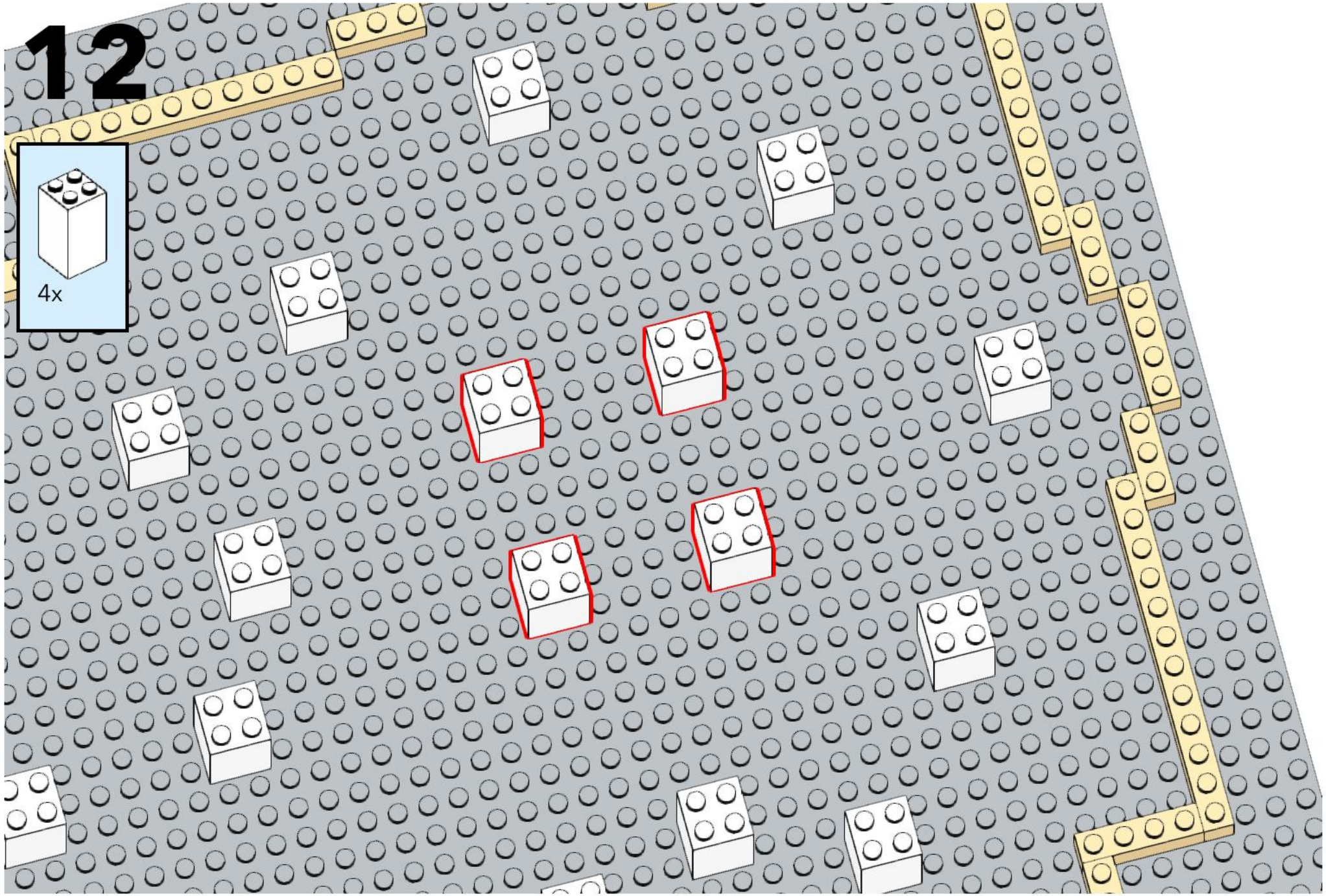
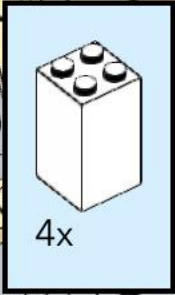



# 14

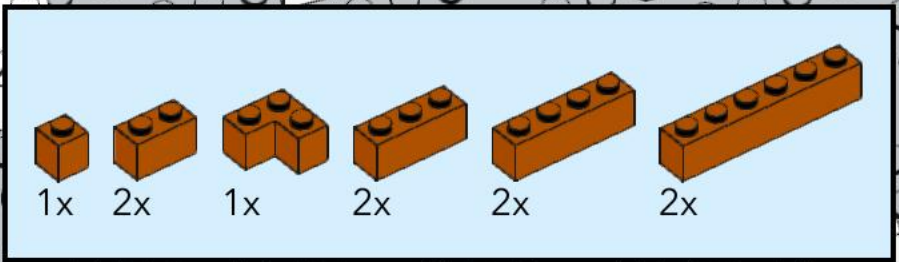

1x 2x 1x 2x 2x 2x

This block contains a list of six brown LEGO Technic parts with their respective quantities: 1x 1-hole brick, 2x 2-hole brick, 1x 2-hole brick with a notch, 2x 3-hole brick, 2x 4-hole brick, and 2x 6-hole brick. The parts are arranged in a row, and the quantities are listed below each part.

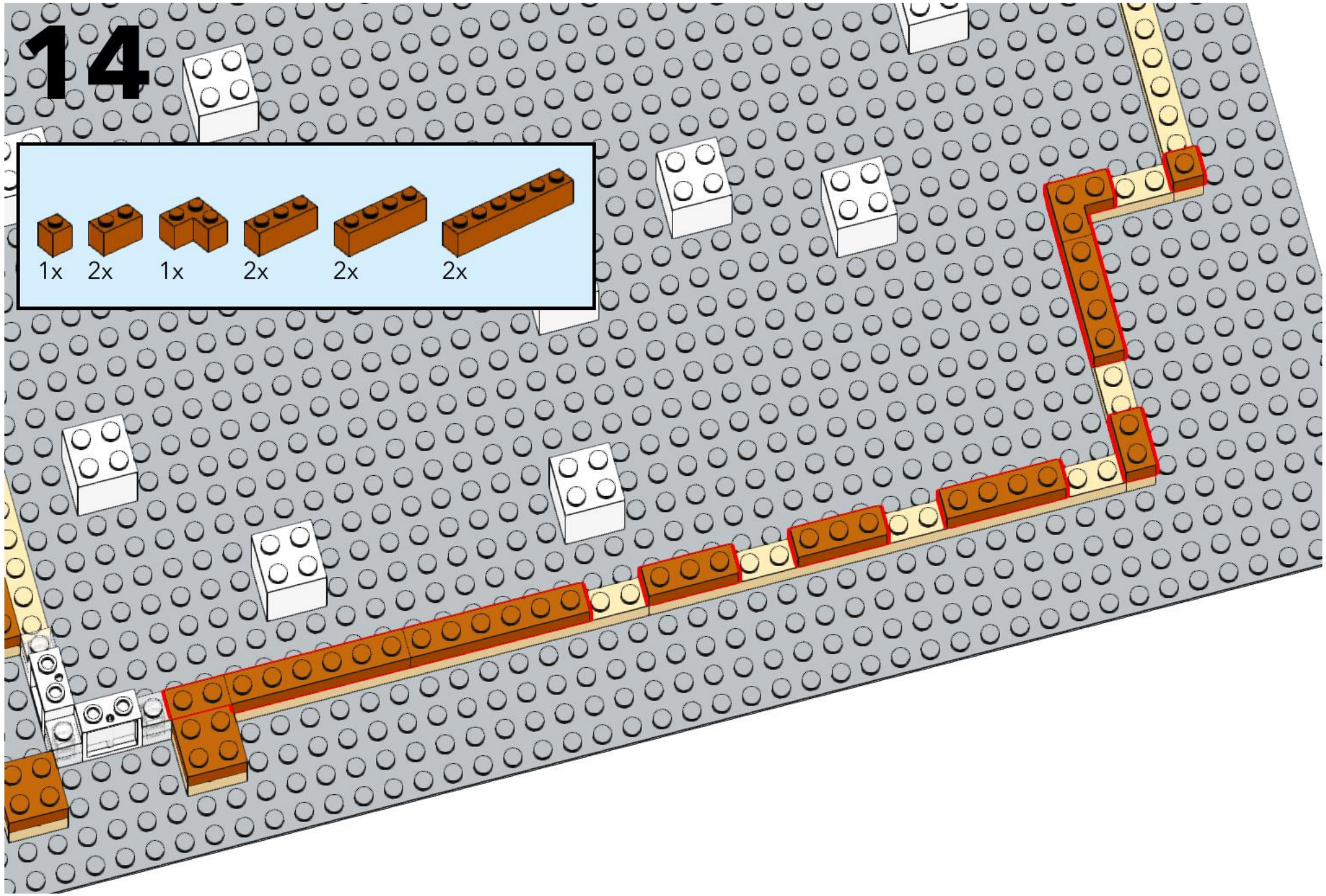

# 15

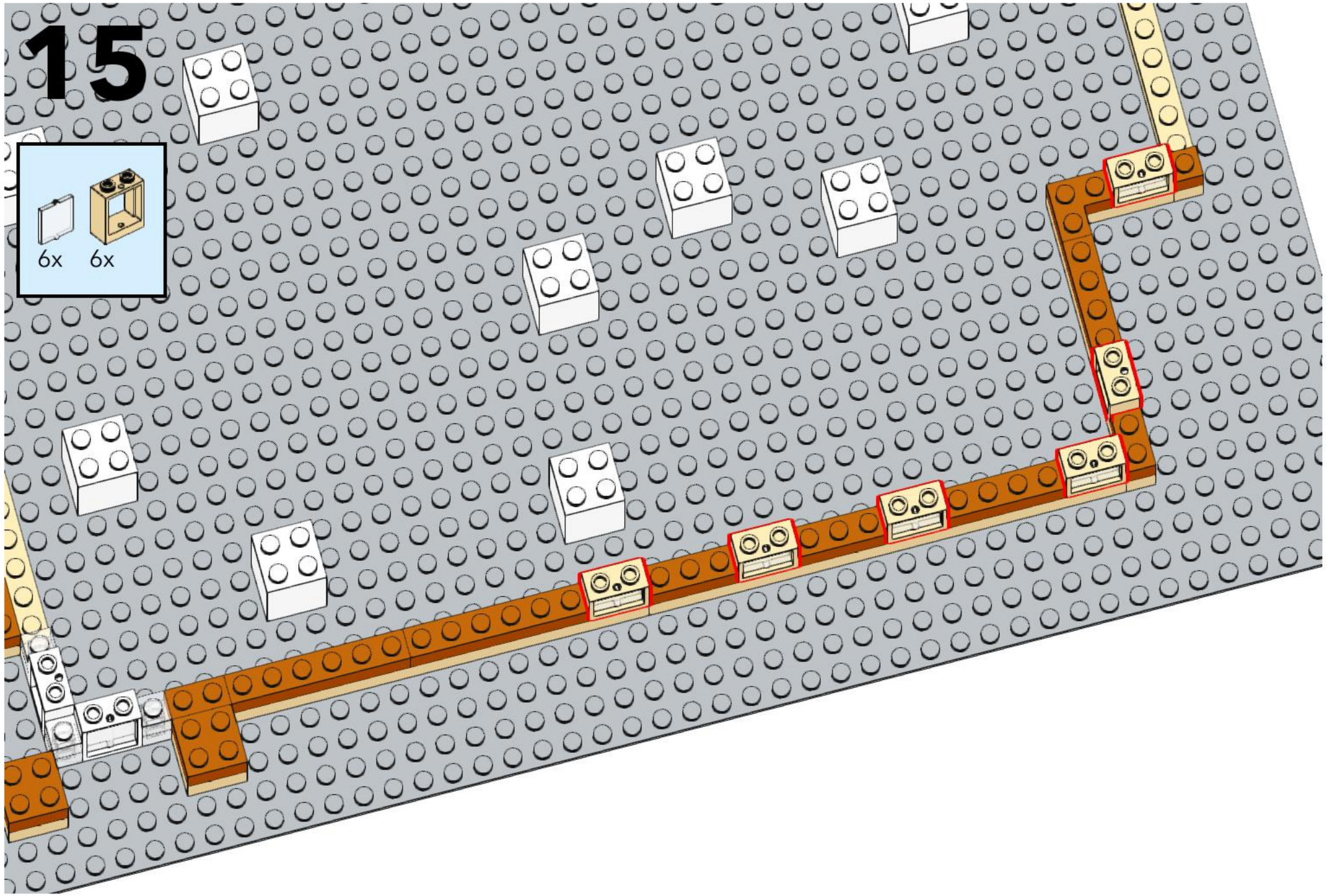
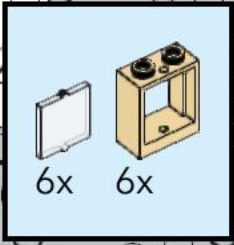



# 16

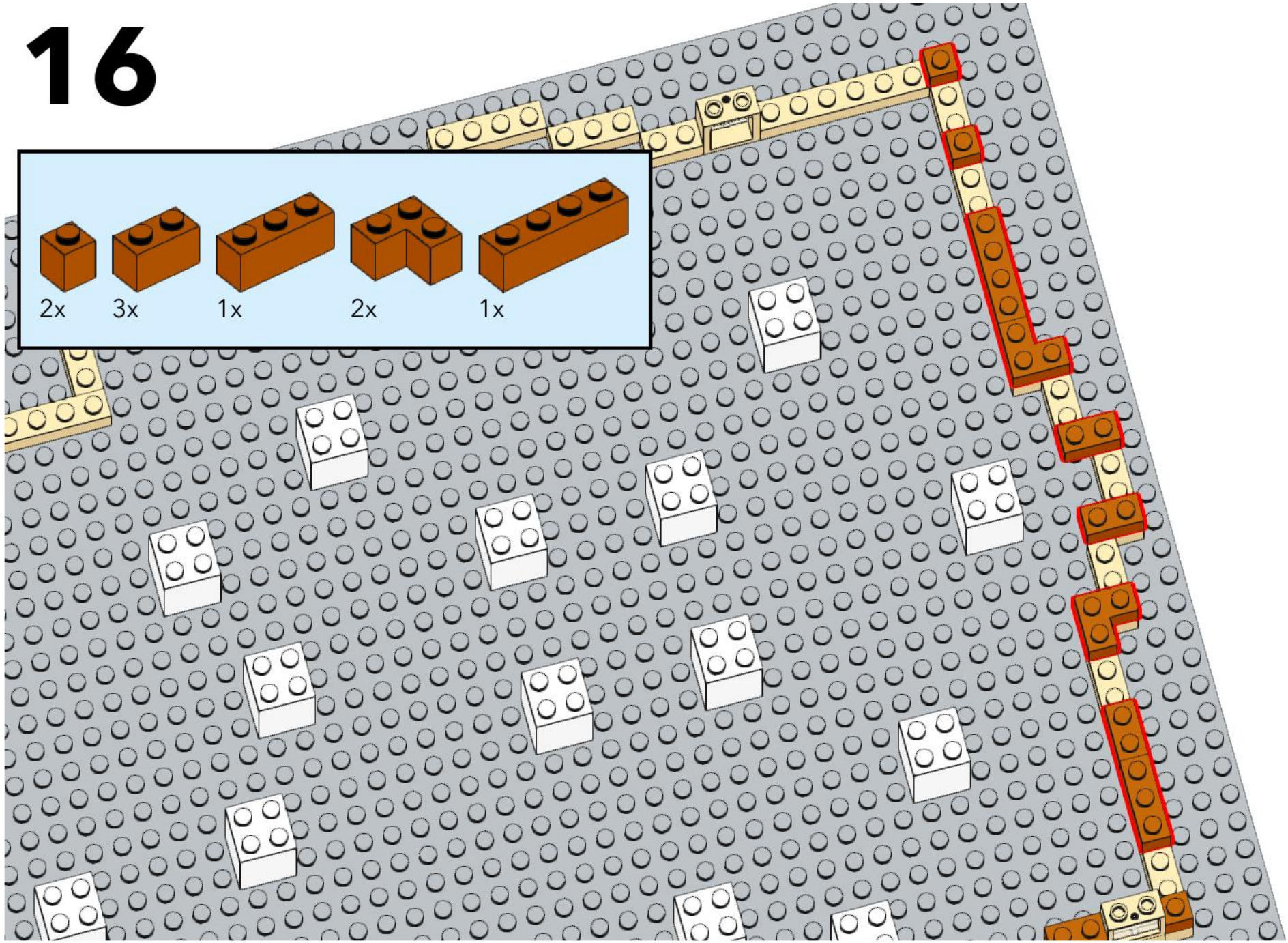
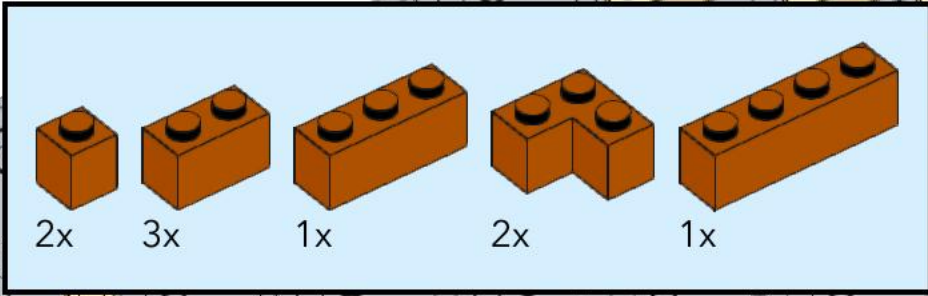

# 17

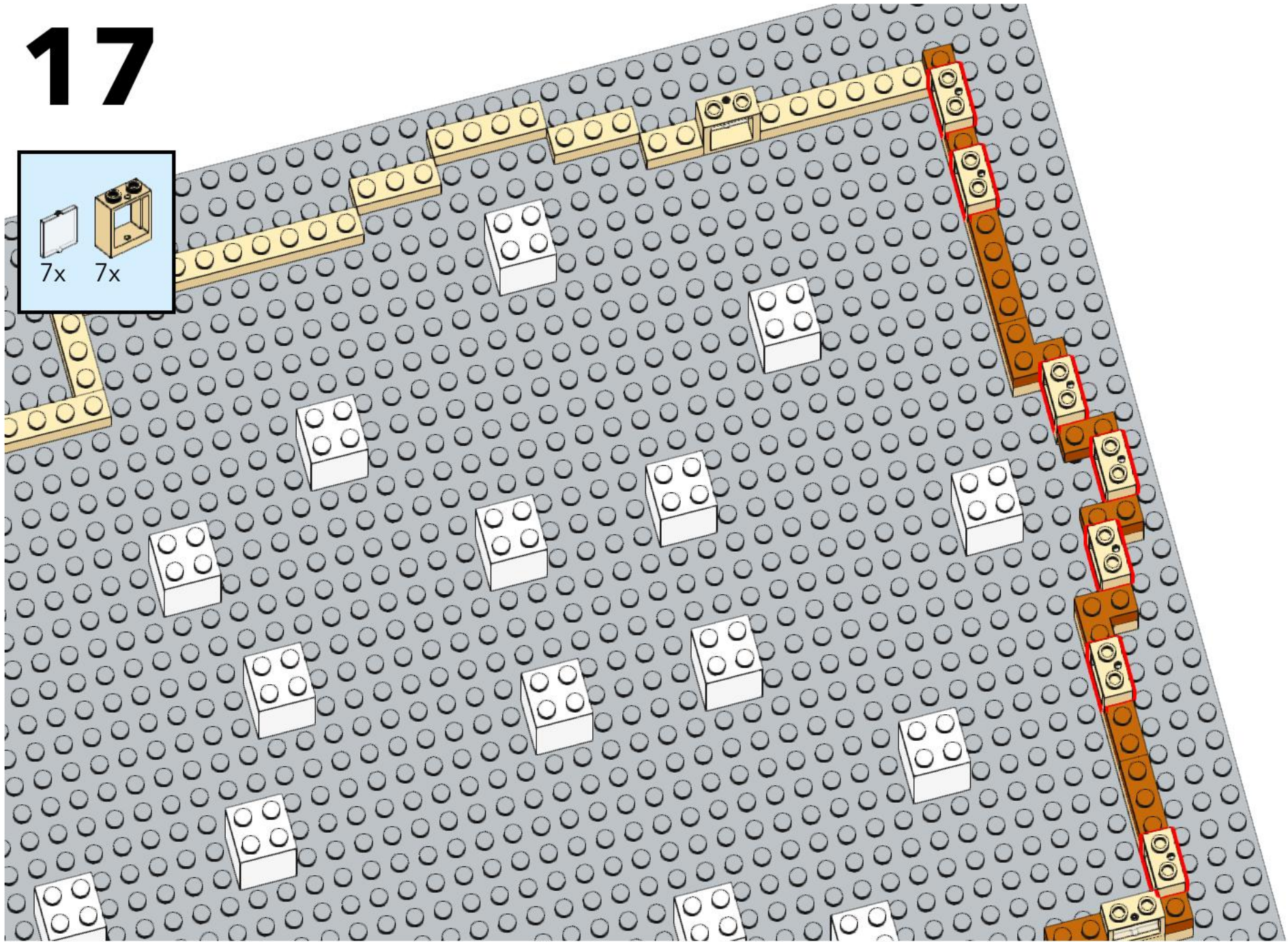
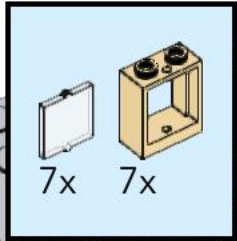

# 18

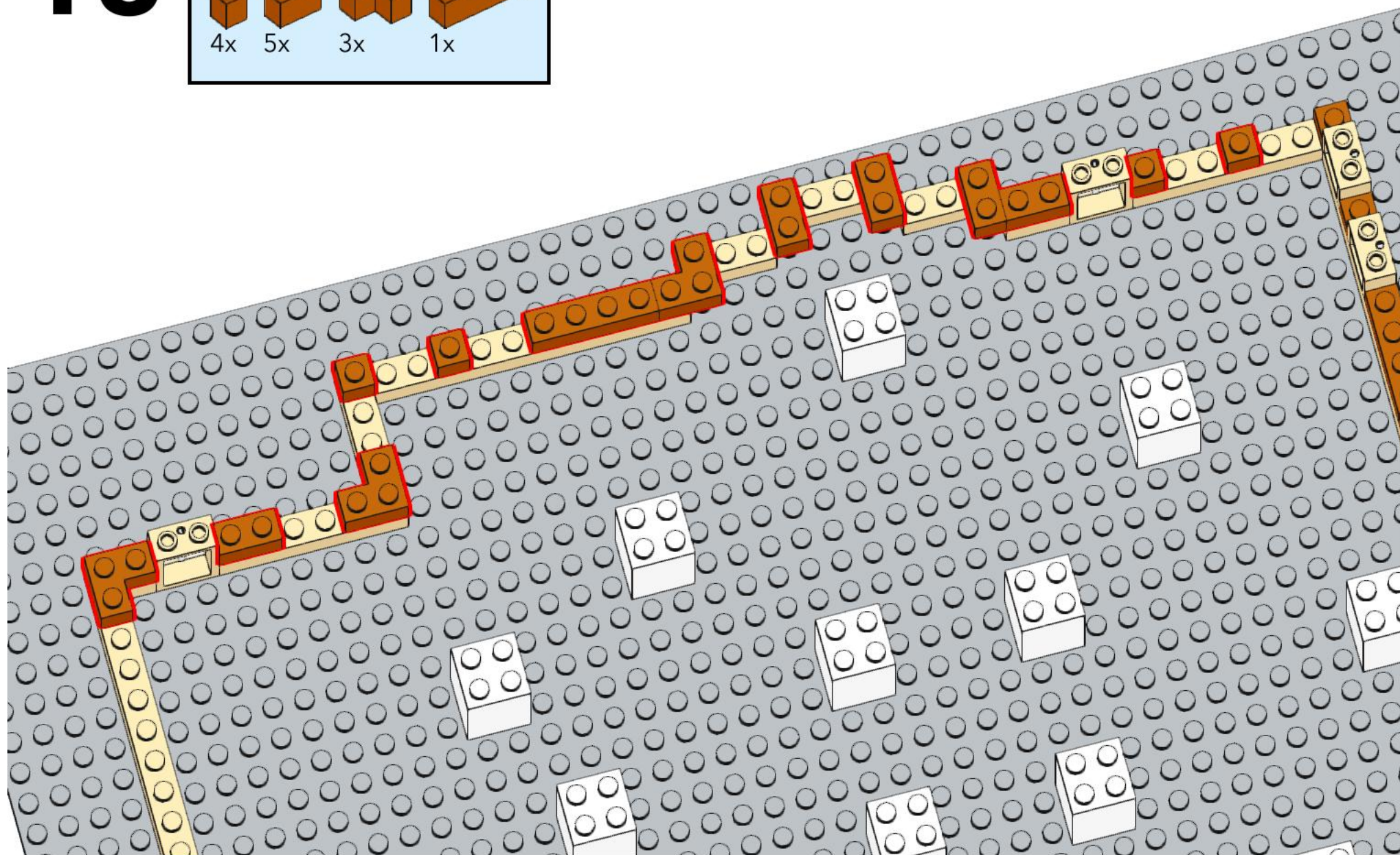
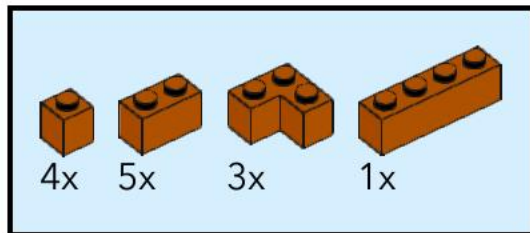

# 19

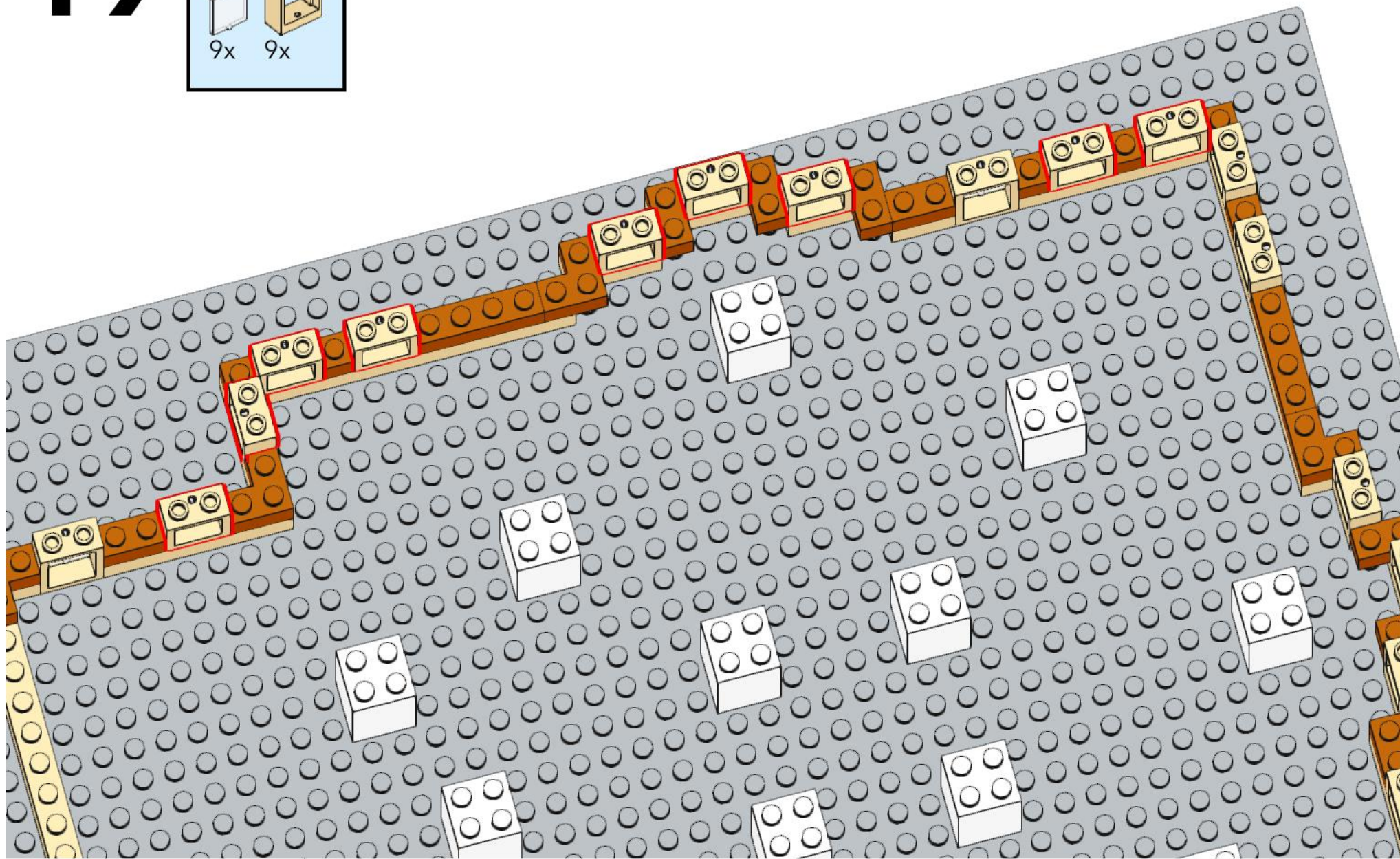
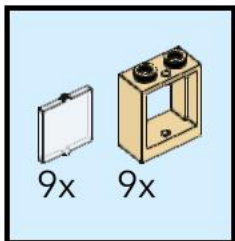

# 20

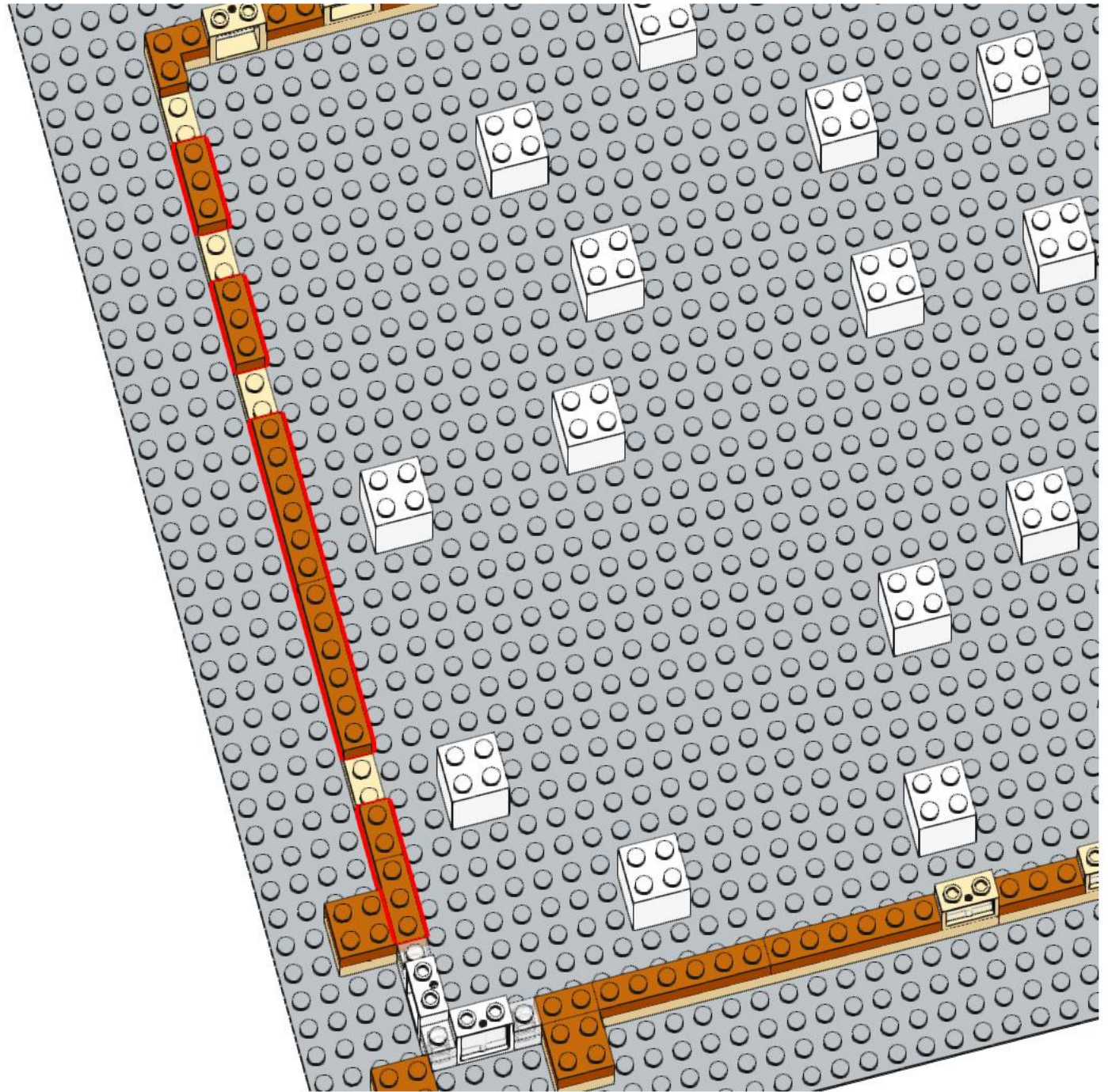
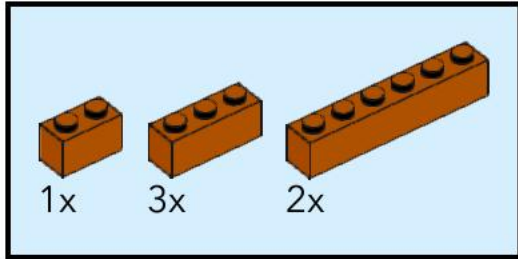

# 21

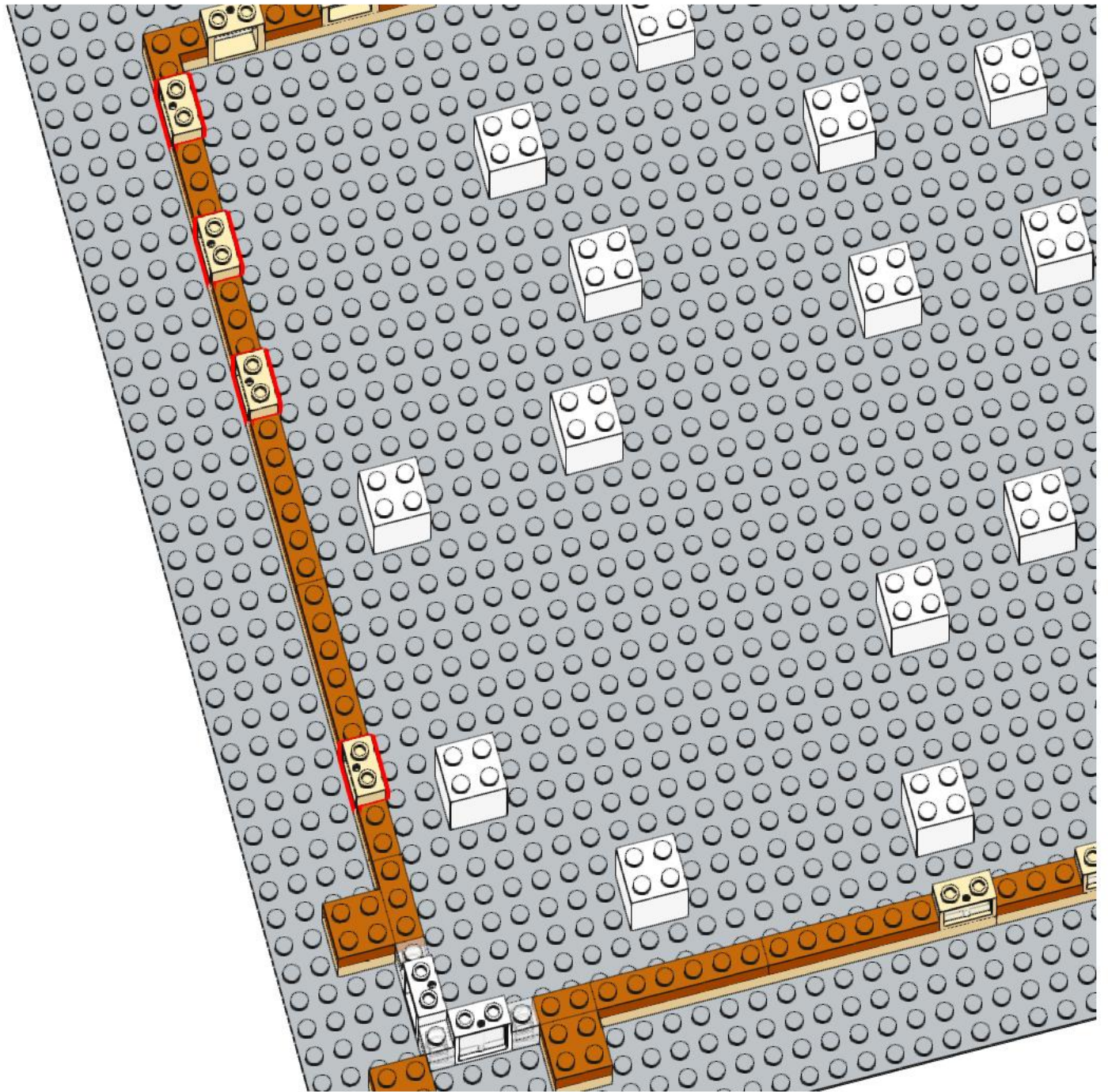
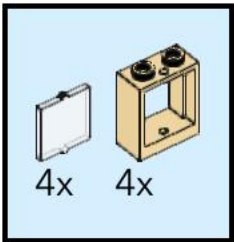

# 22

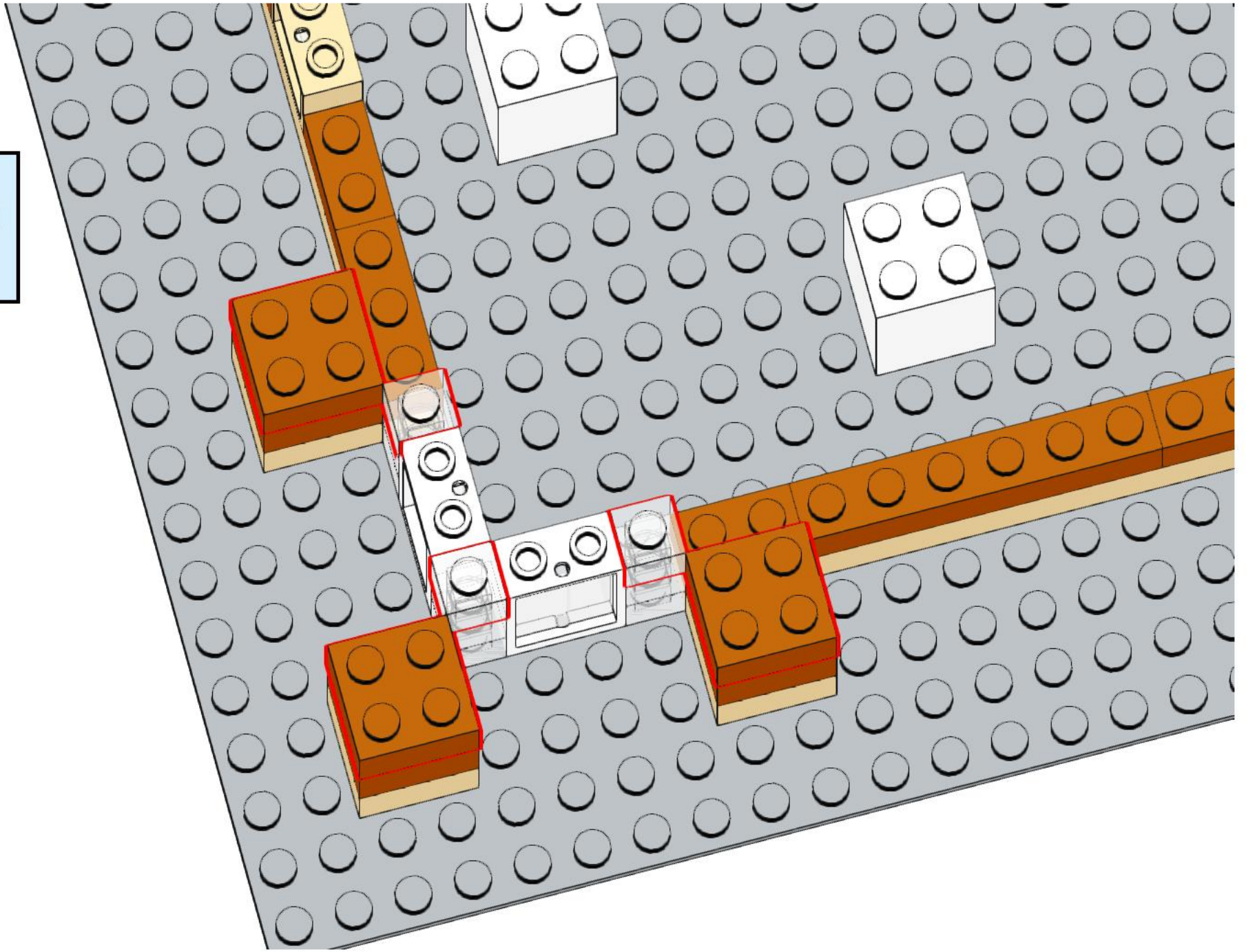
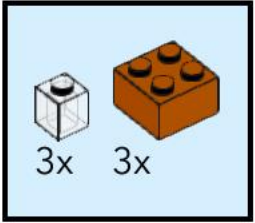

# 23

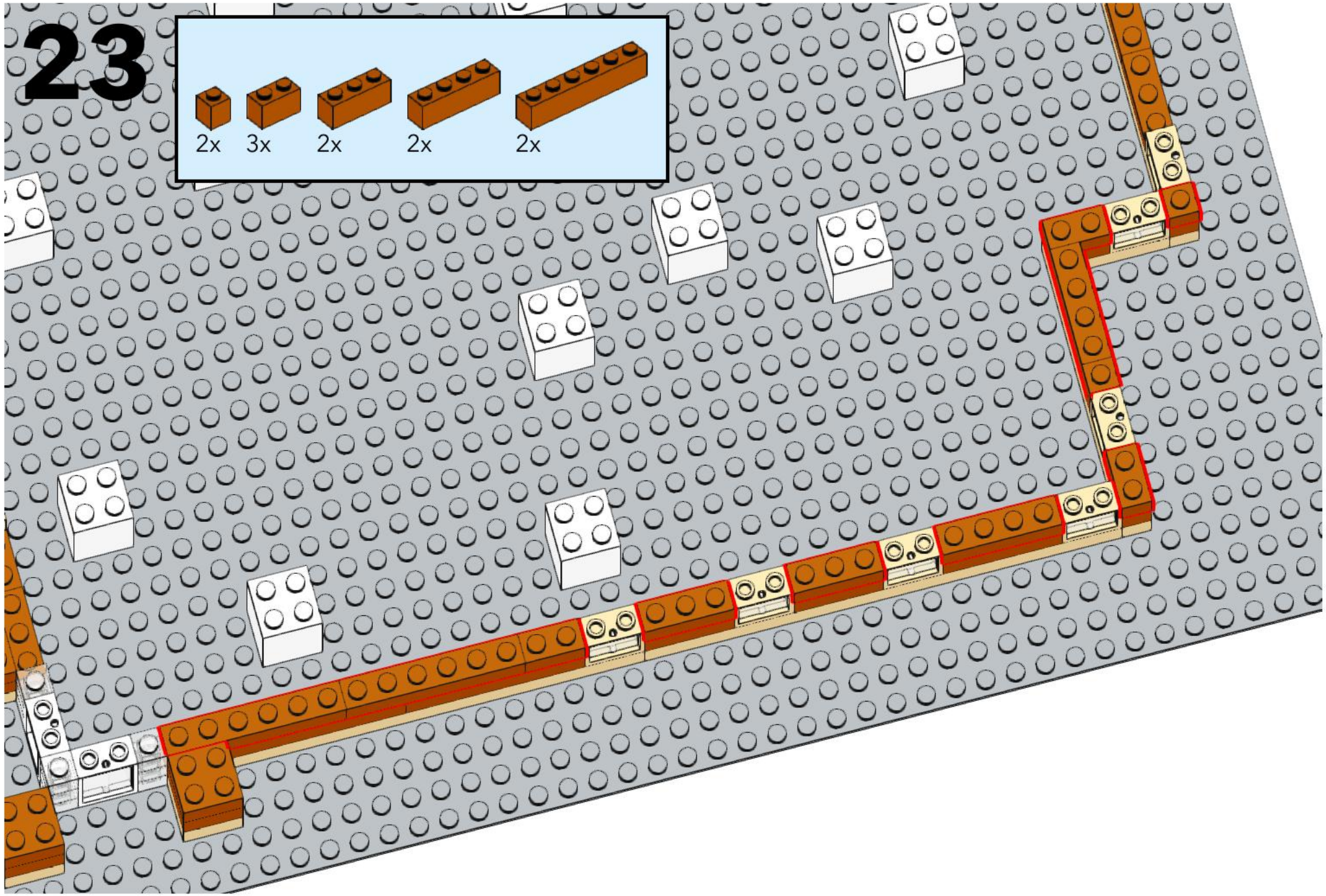
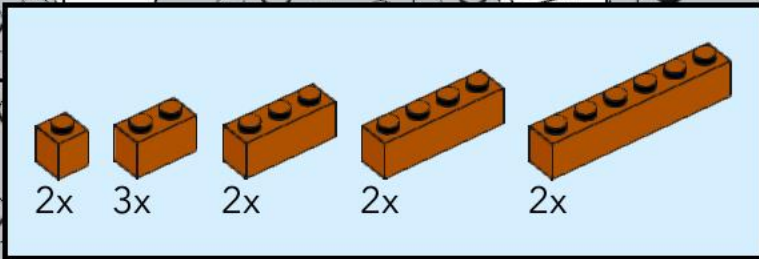



# 24

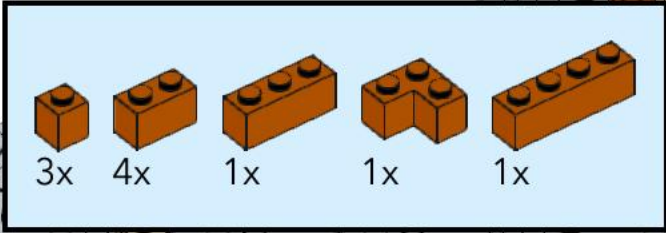

3x 4x 1x 1x 1x

This inset box lists the parts required for step 24: three 1x1 brown bricks, four 1x2 brown bricks, one 1x3 brown brick, one 1x2 brown brick with a notch, and one 1x4 brown brick. The quantities are listed below each corresponding part illustration.

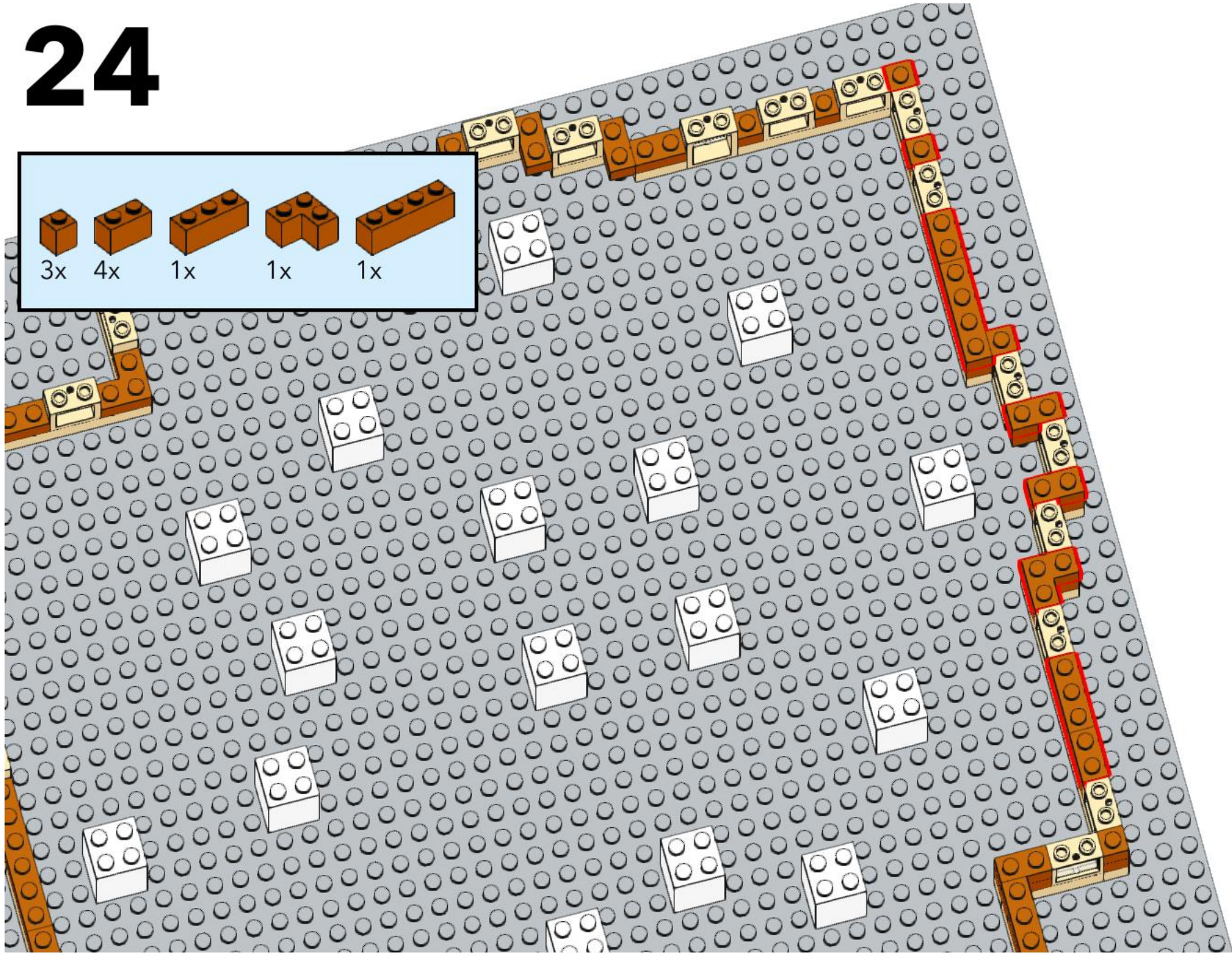

# 25

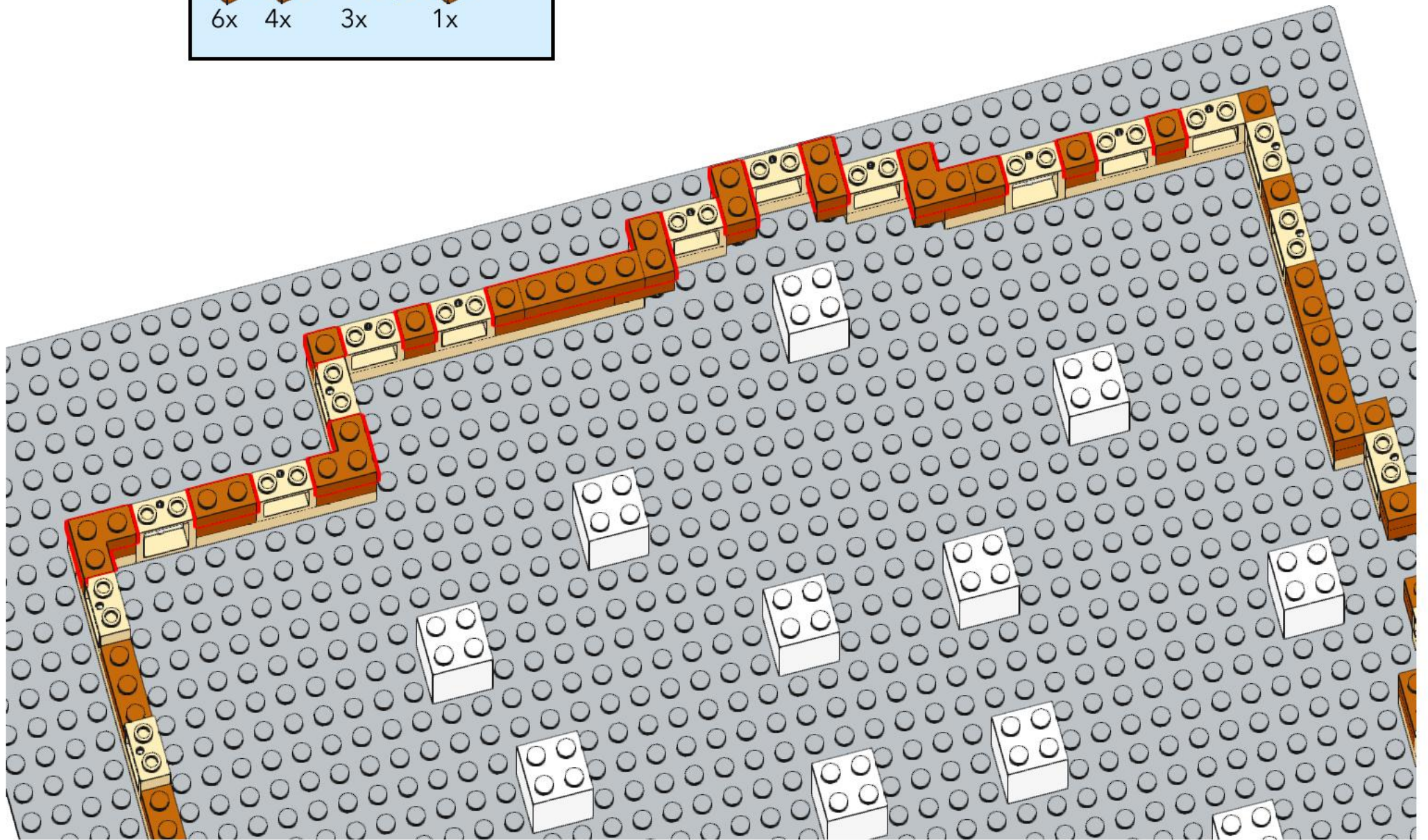
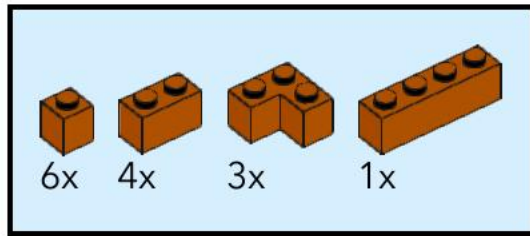

# 26

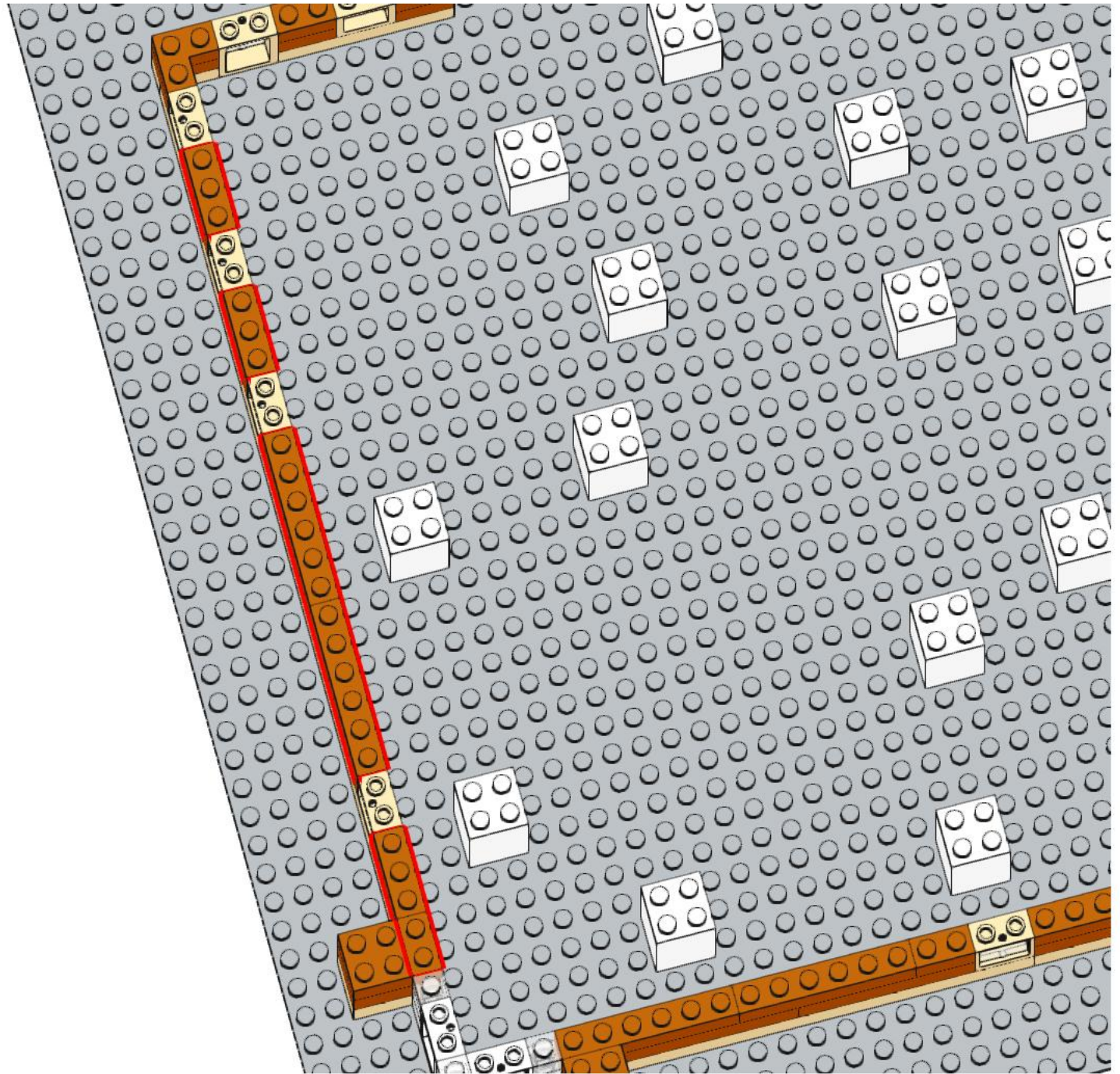
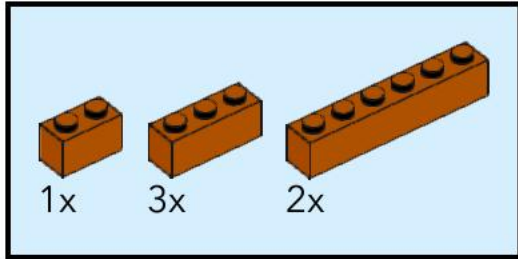

# 27

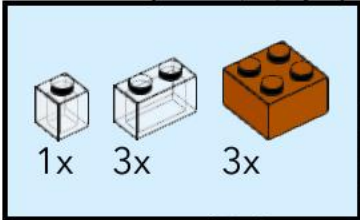

1x 3x 3x

This inset box lists the required parts for step 27: one white 1x1 Technic brick with a hole, three white 1x2 Technic bricks with holes, and three brown 1x2 Technic bricks with holes. The quantities are indicated by '1x', '3x', and '3x' respectively.

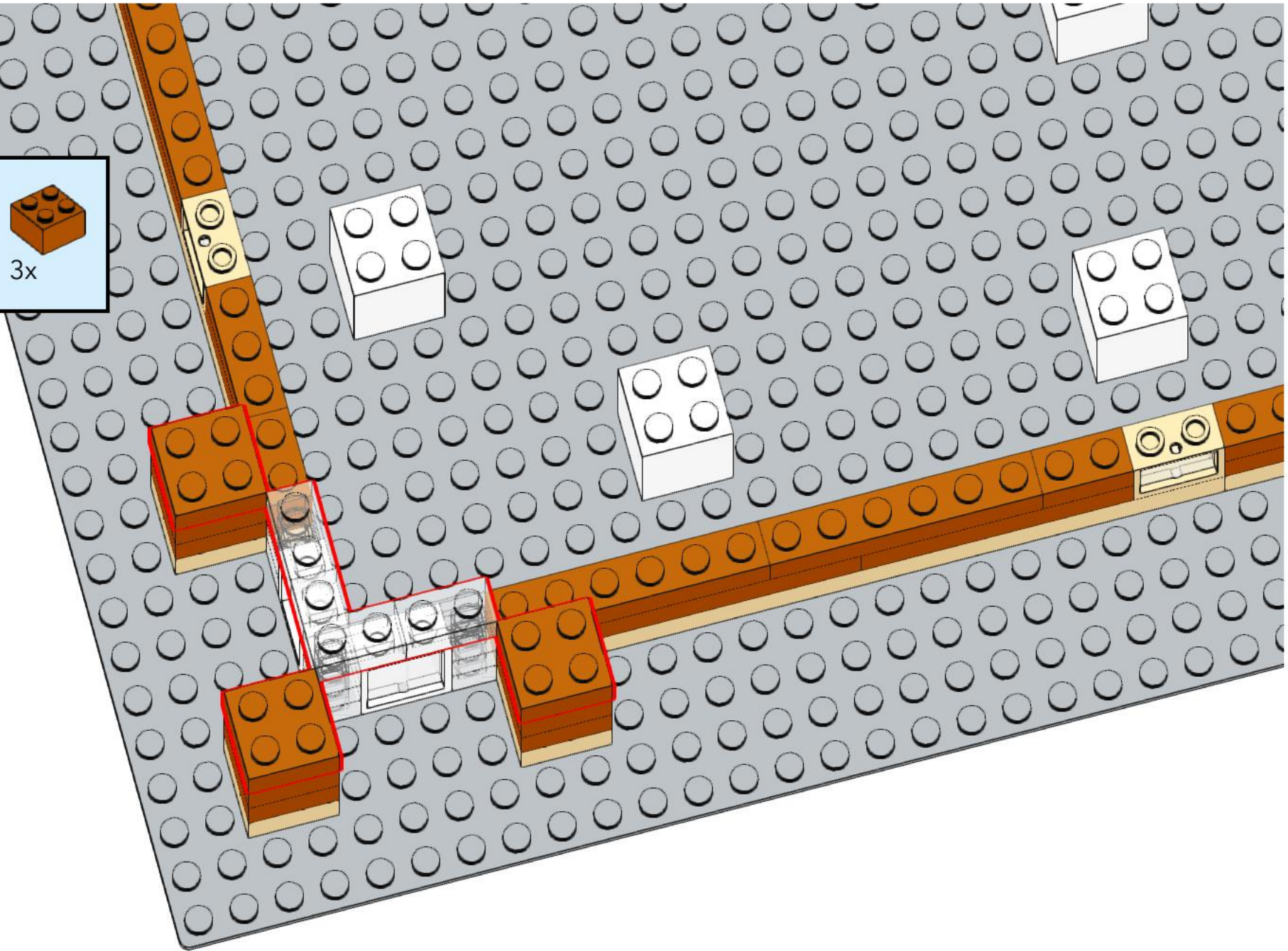

# 28

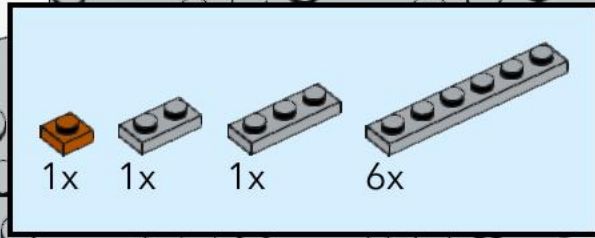

1x 1x 1x 6x

This block contains a list of parts for step 28. It includes one brown 1x1 brick, one grey 1x2 brick, one grey 1x3 brick, and six grey 1x6 Technic axles. The parts are arranged in a row with their respective quantities below them.

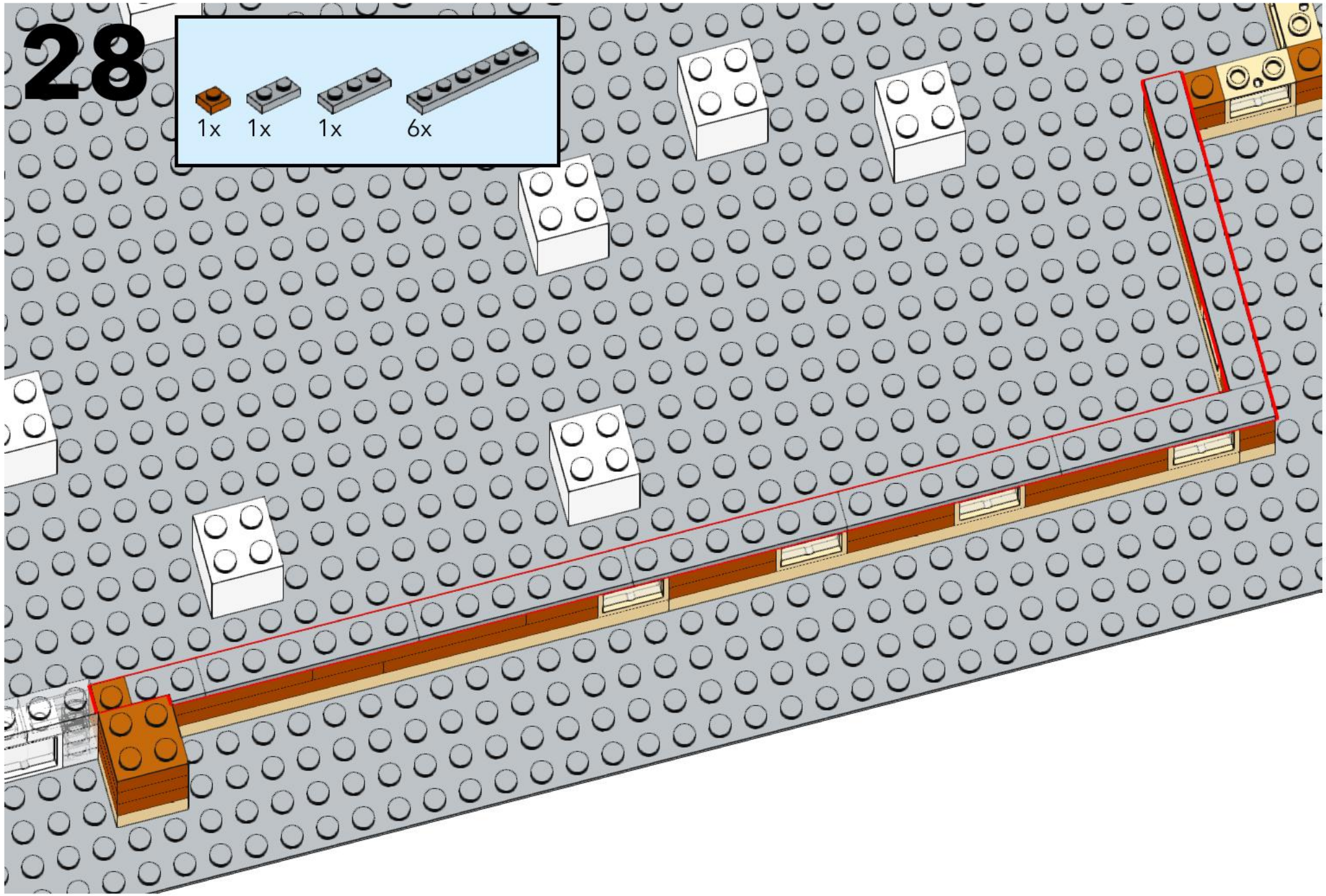

# 29

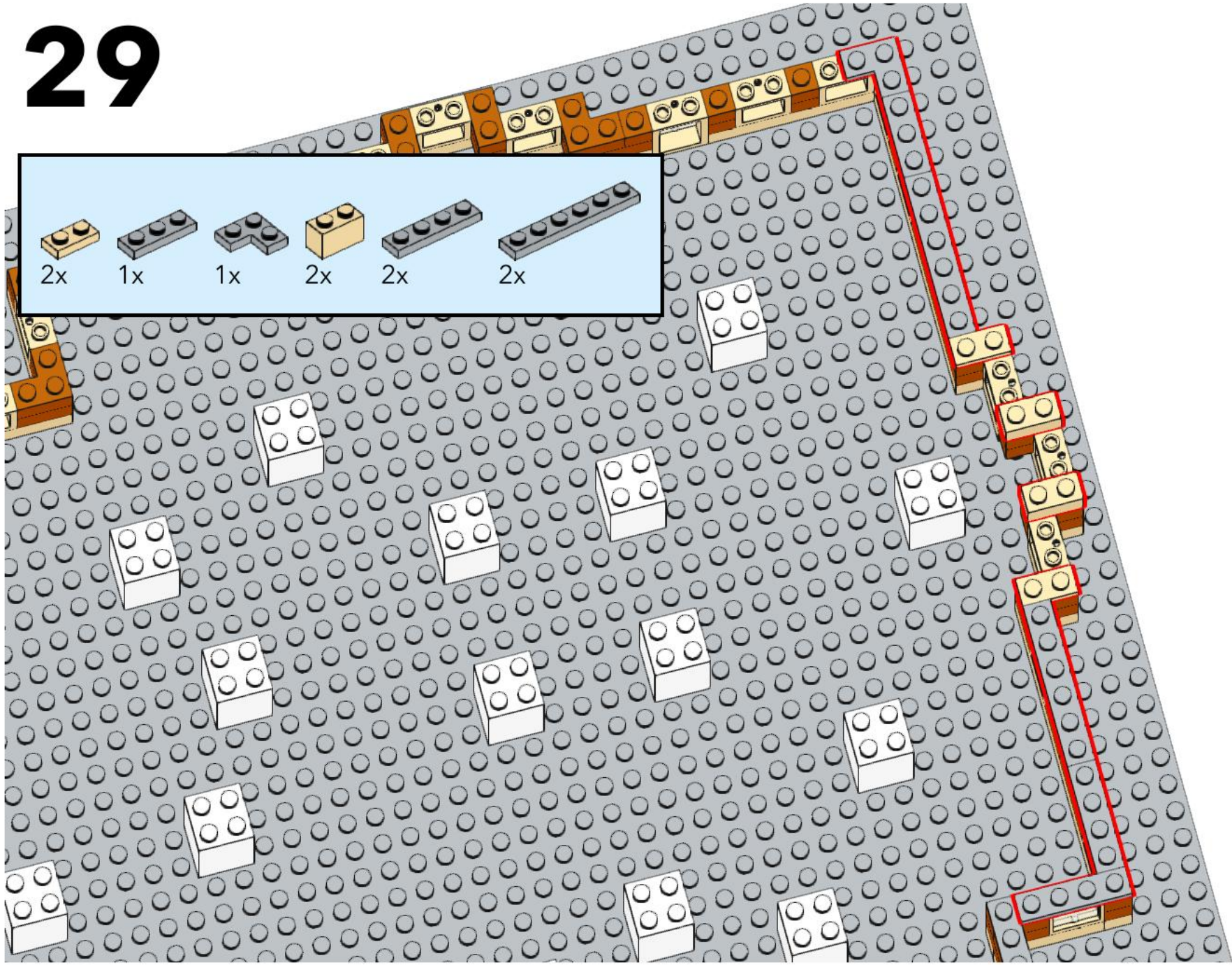

30

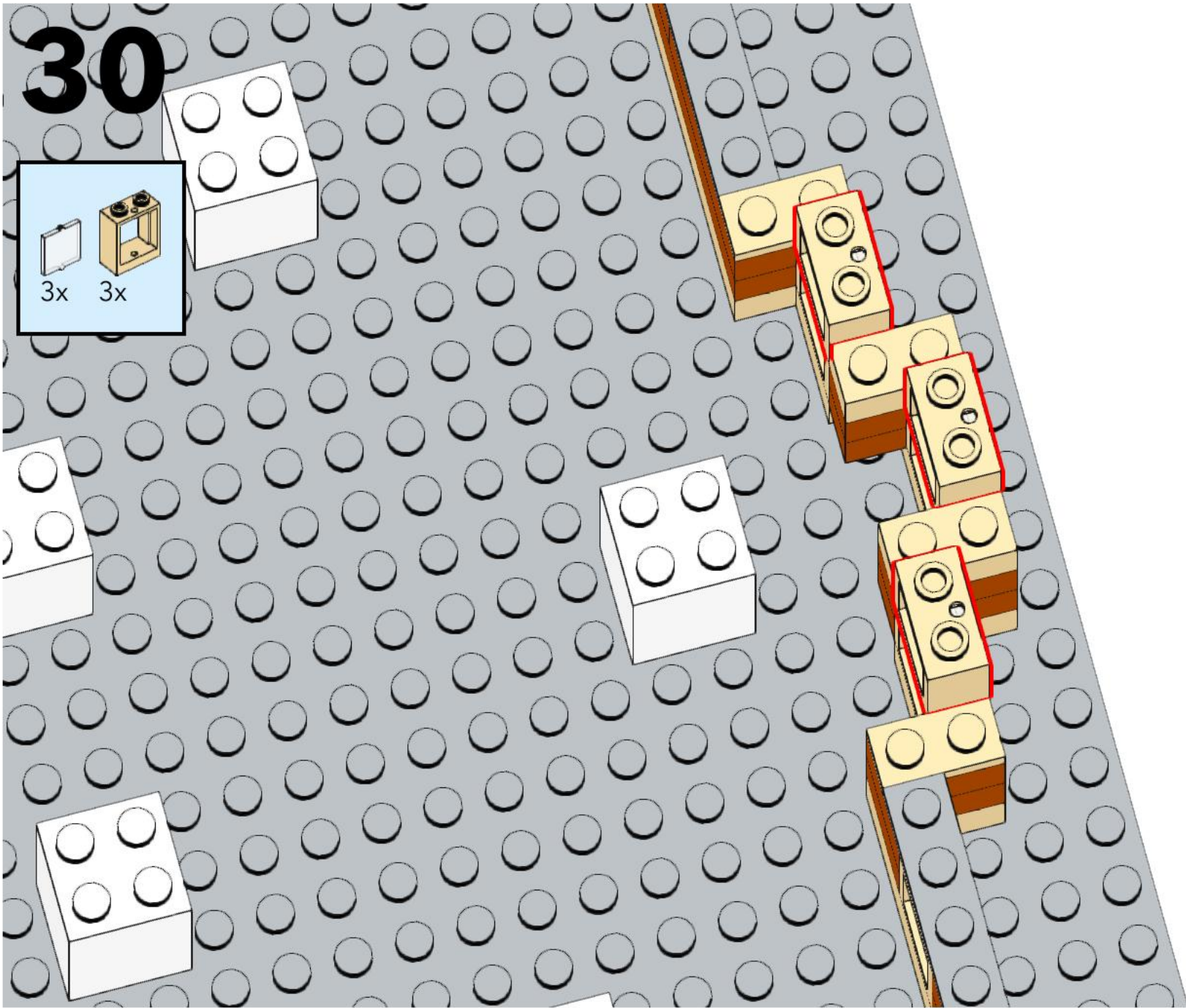
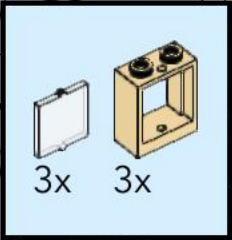

# 31

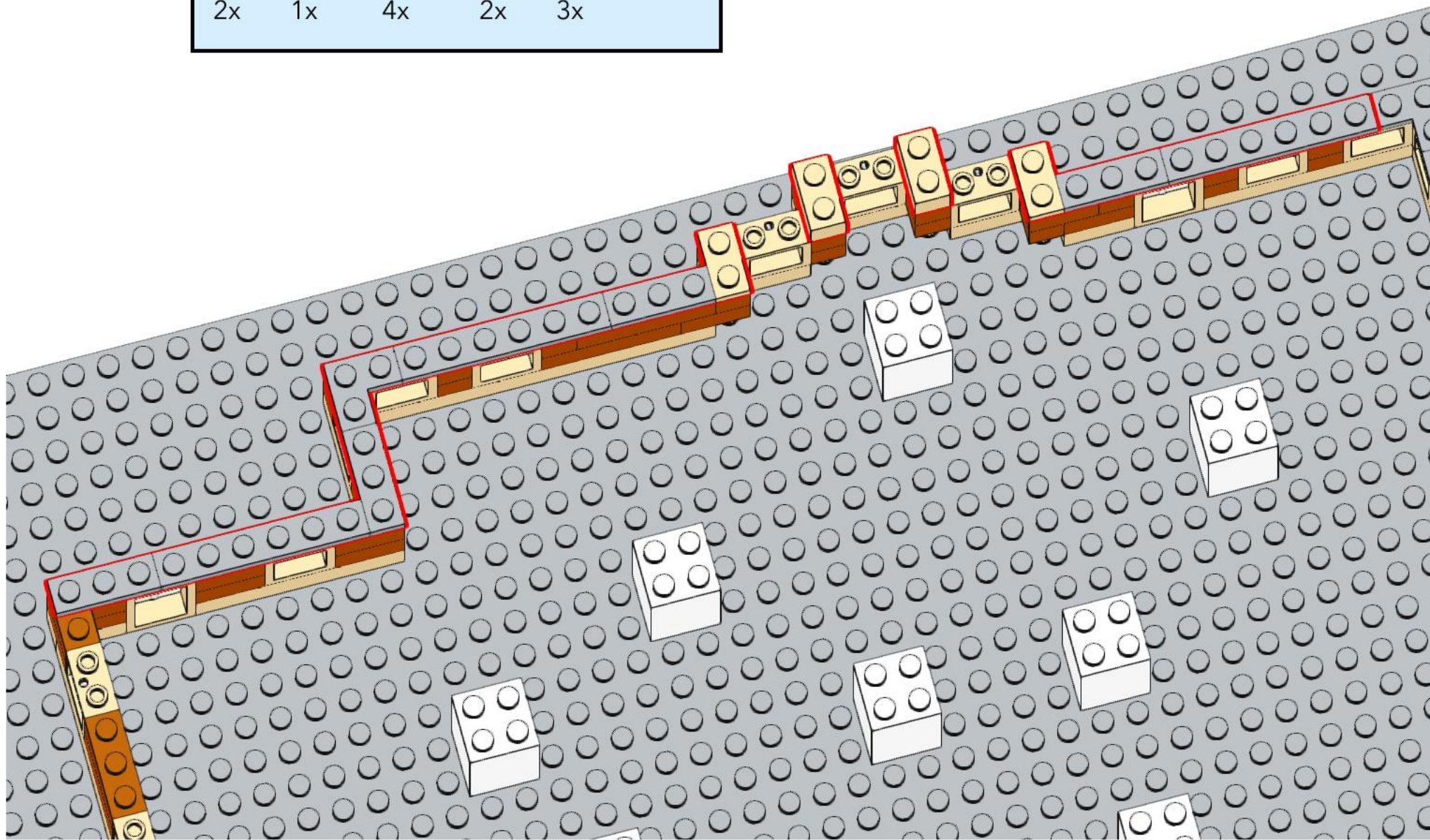
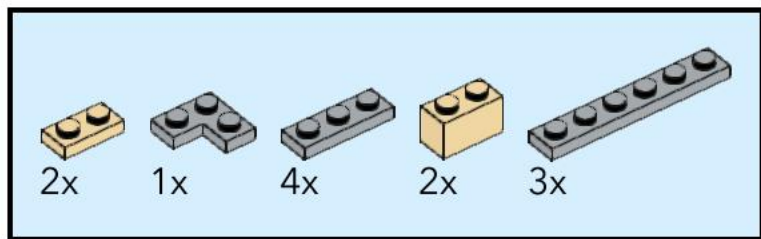



# 32

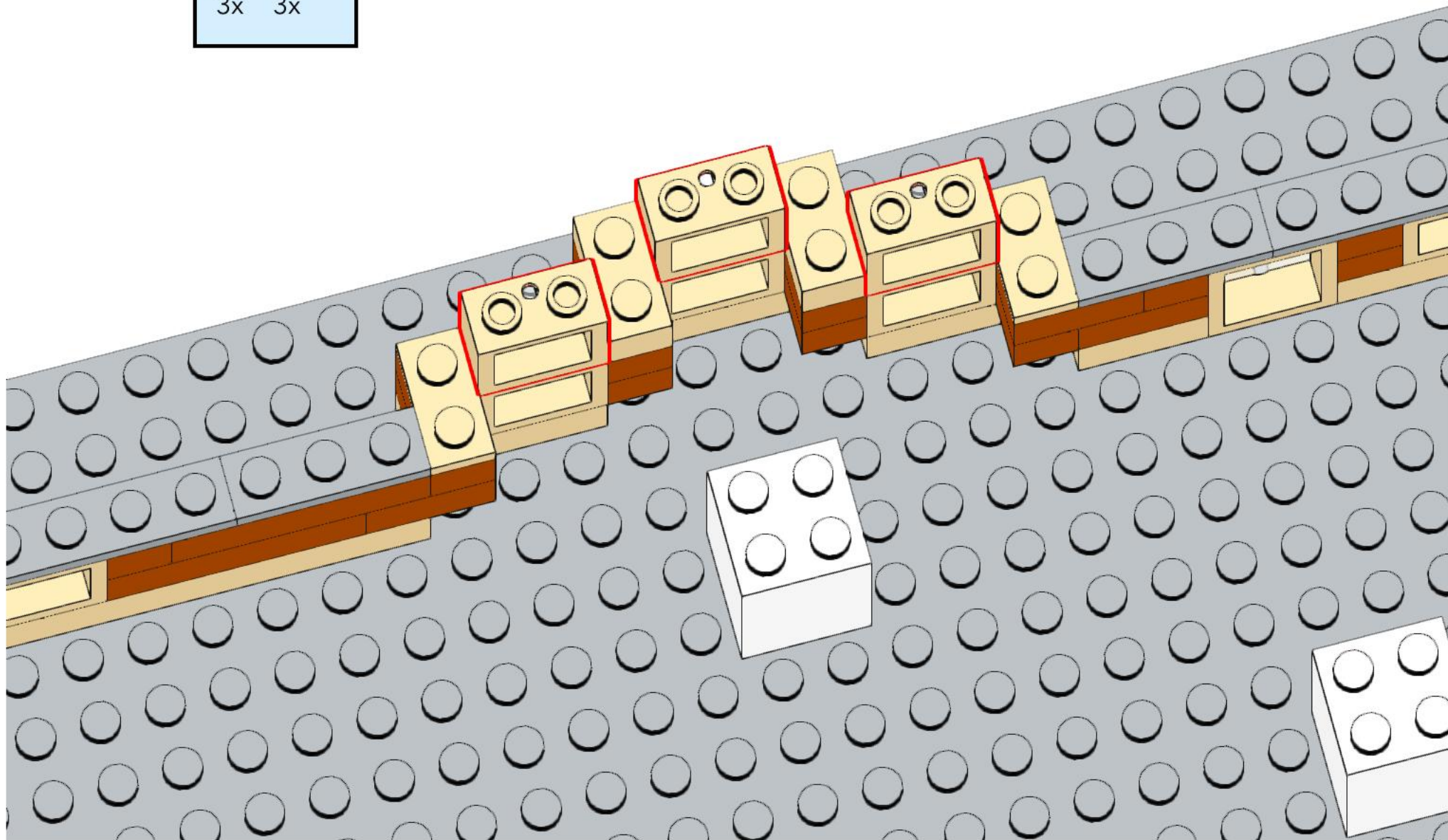
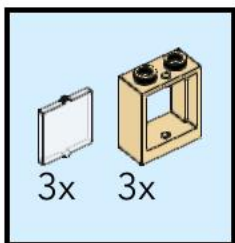

# 33

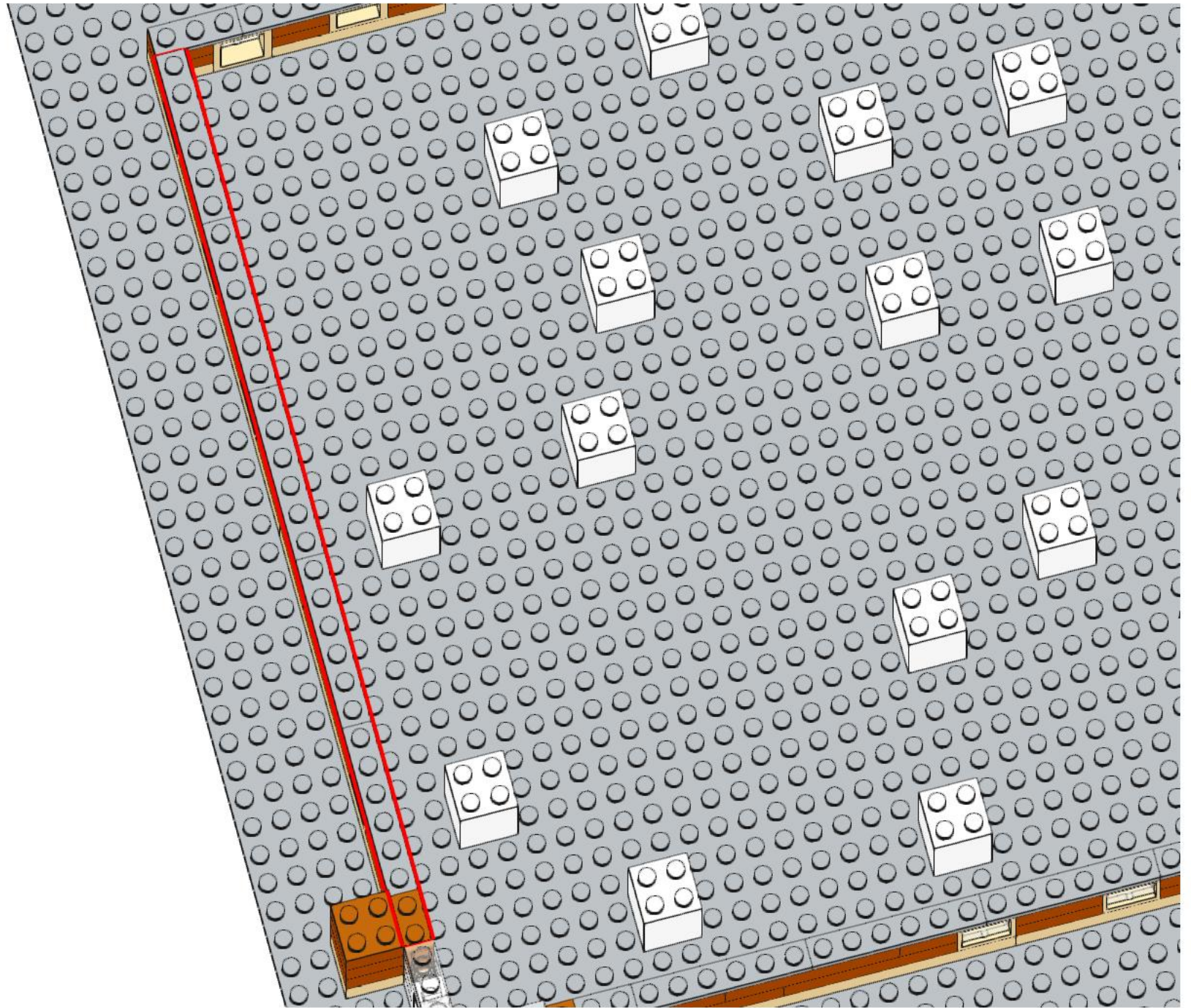
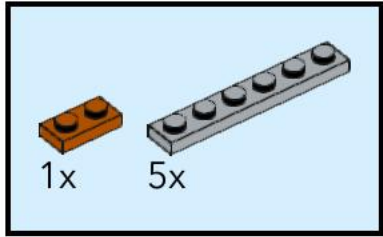

# 34

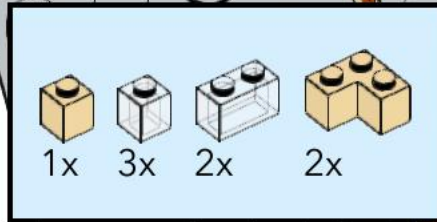

1x 3x 2x 2x

This block contains a parts list for step 34. It features four items: a tan 1x1 brick (1x), three tan 1x1 bricks (3x), two tan 1x2 bricks (2x), and two tan 1x2 bricks (2x). The items are arranged in a row with their respective quantities below them.

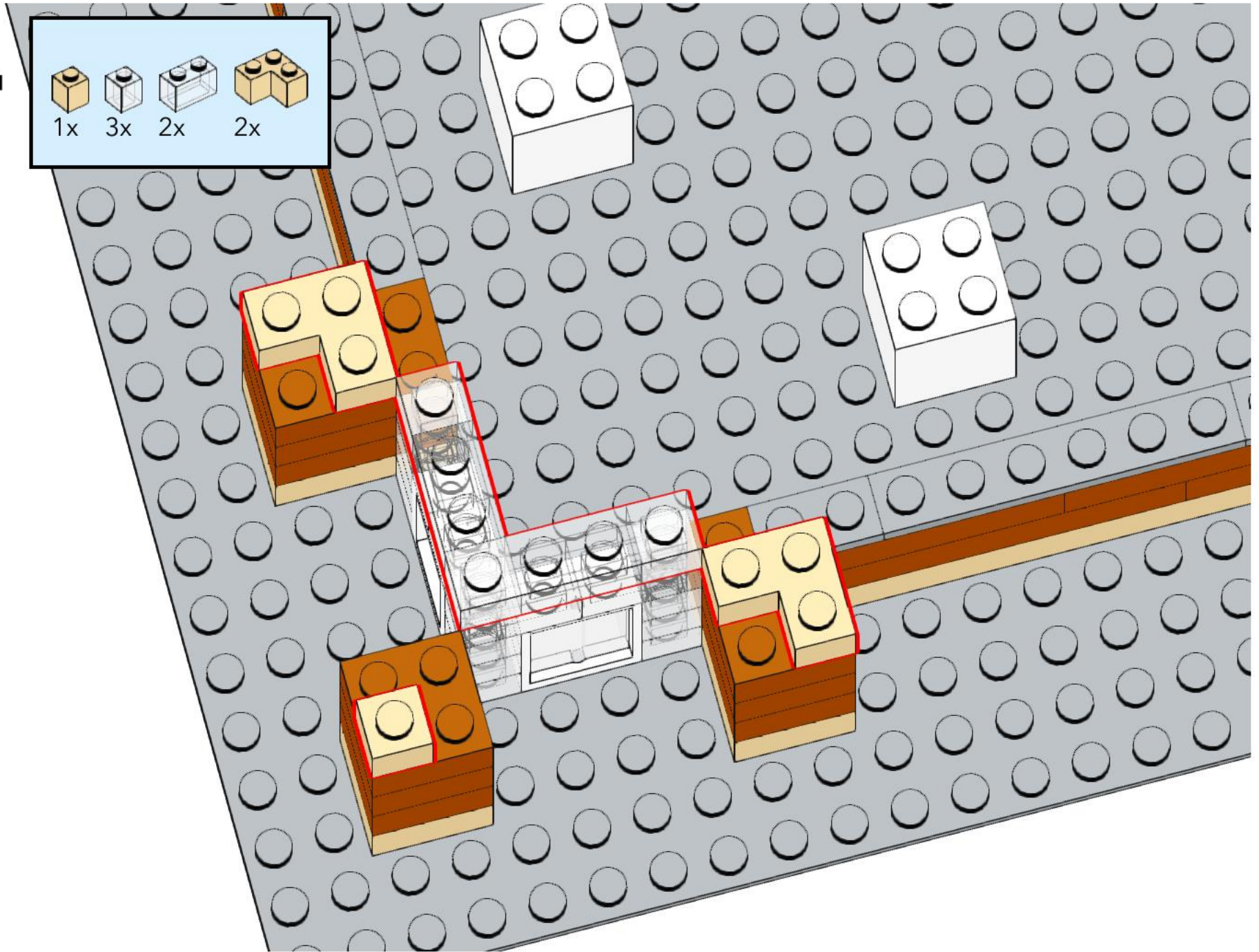

# 35

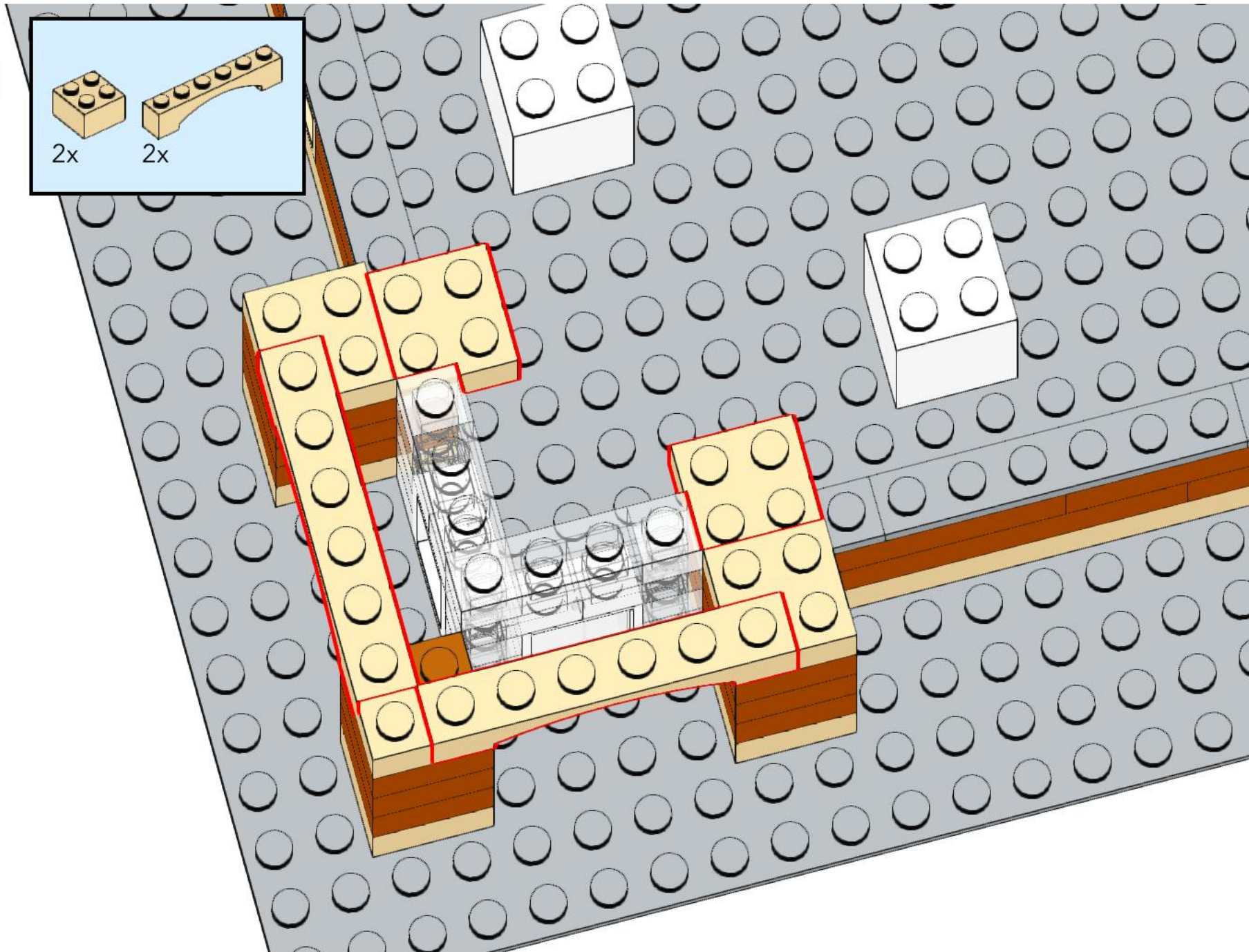
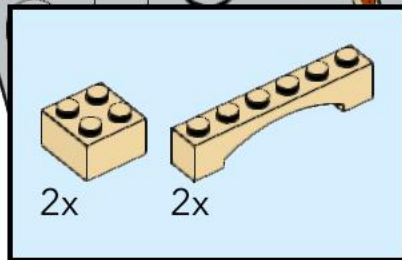

# 36

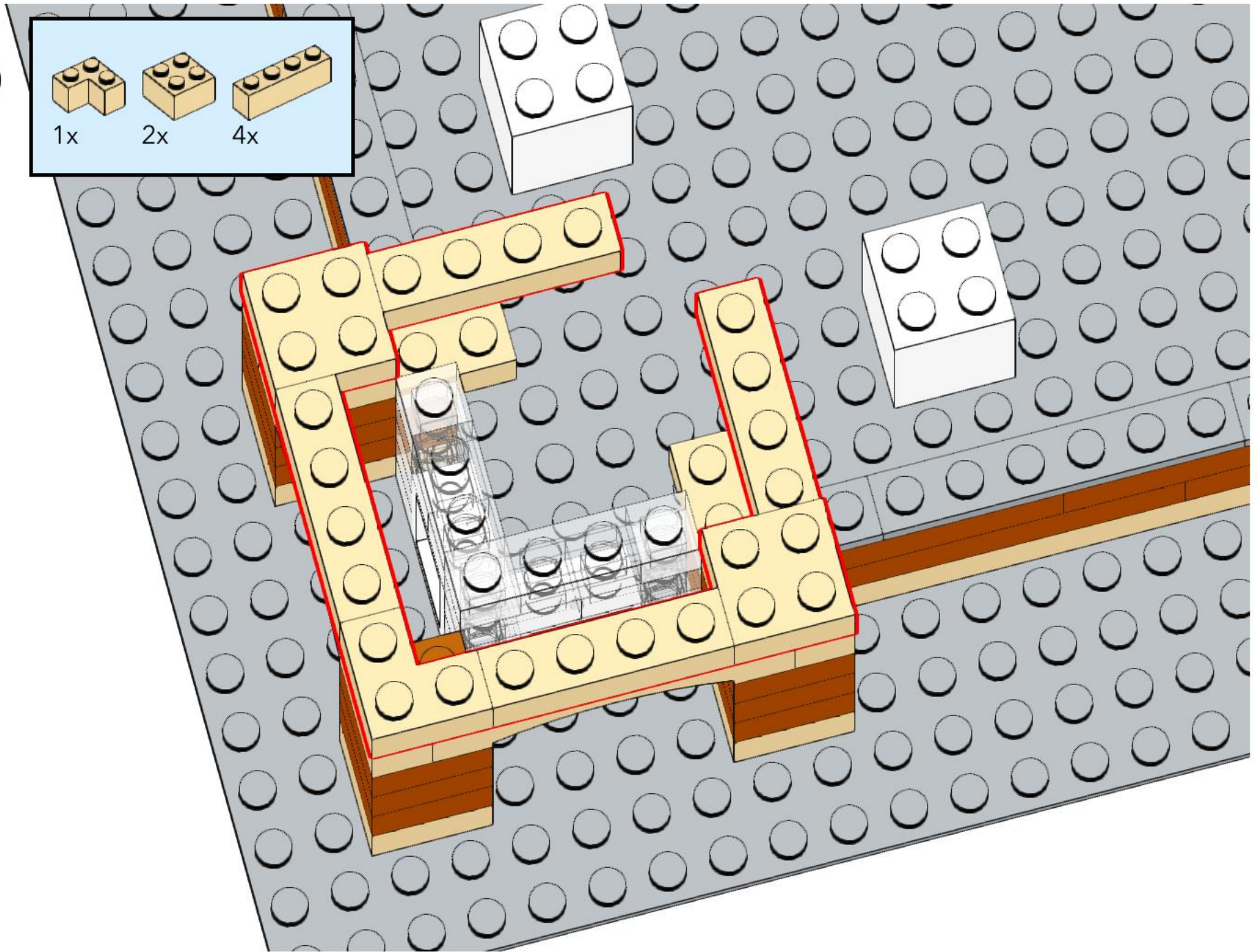
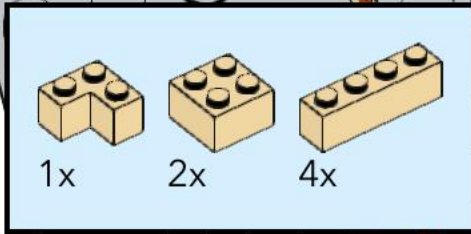

37

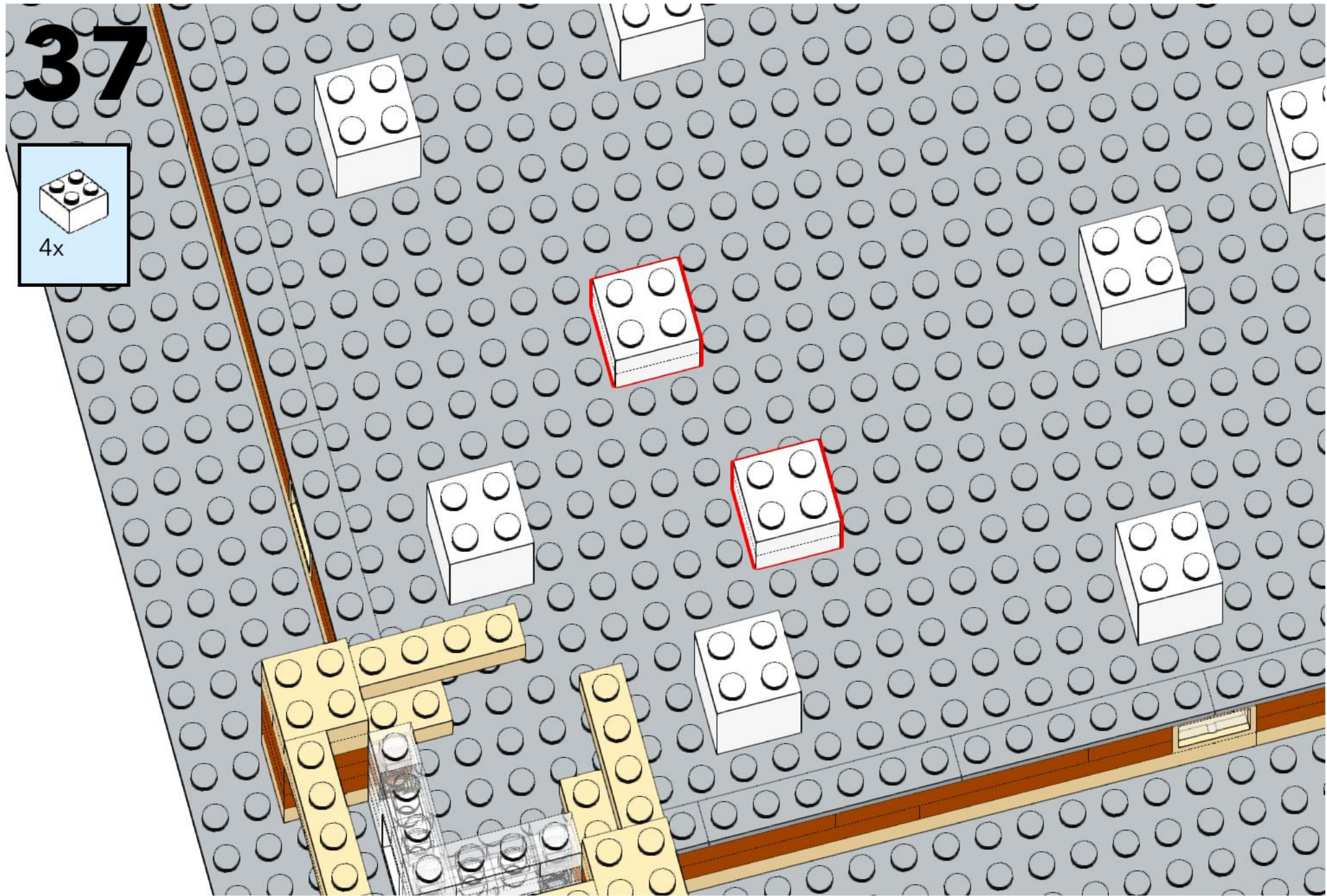
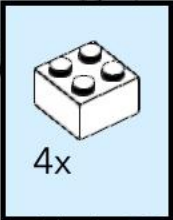

38

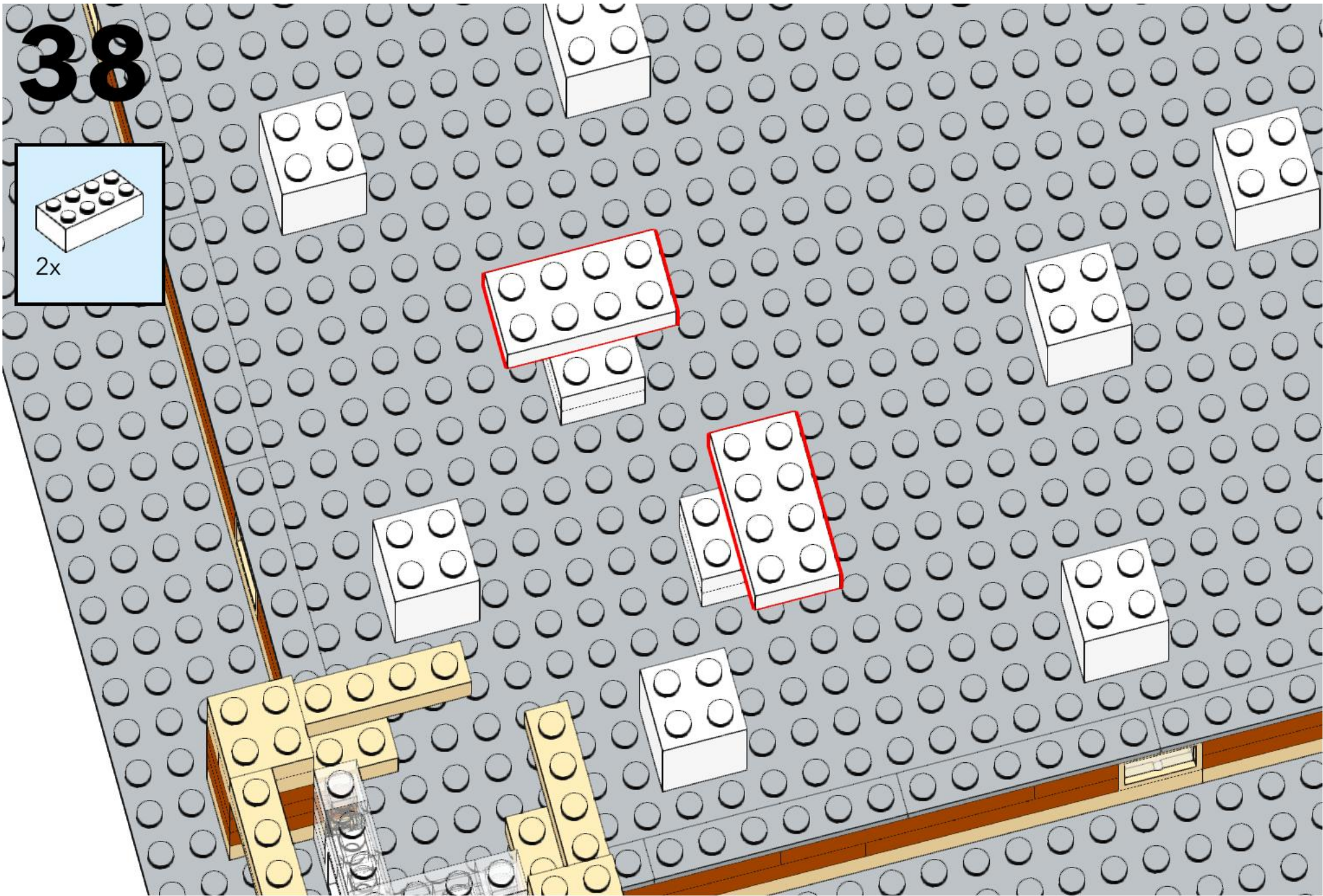
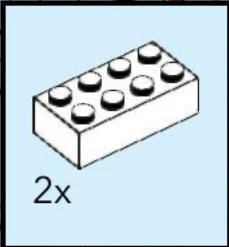

39

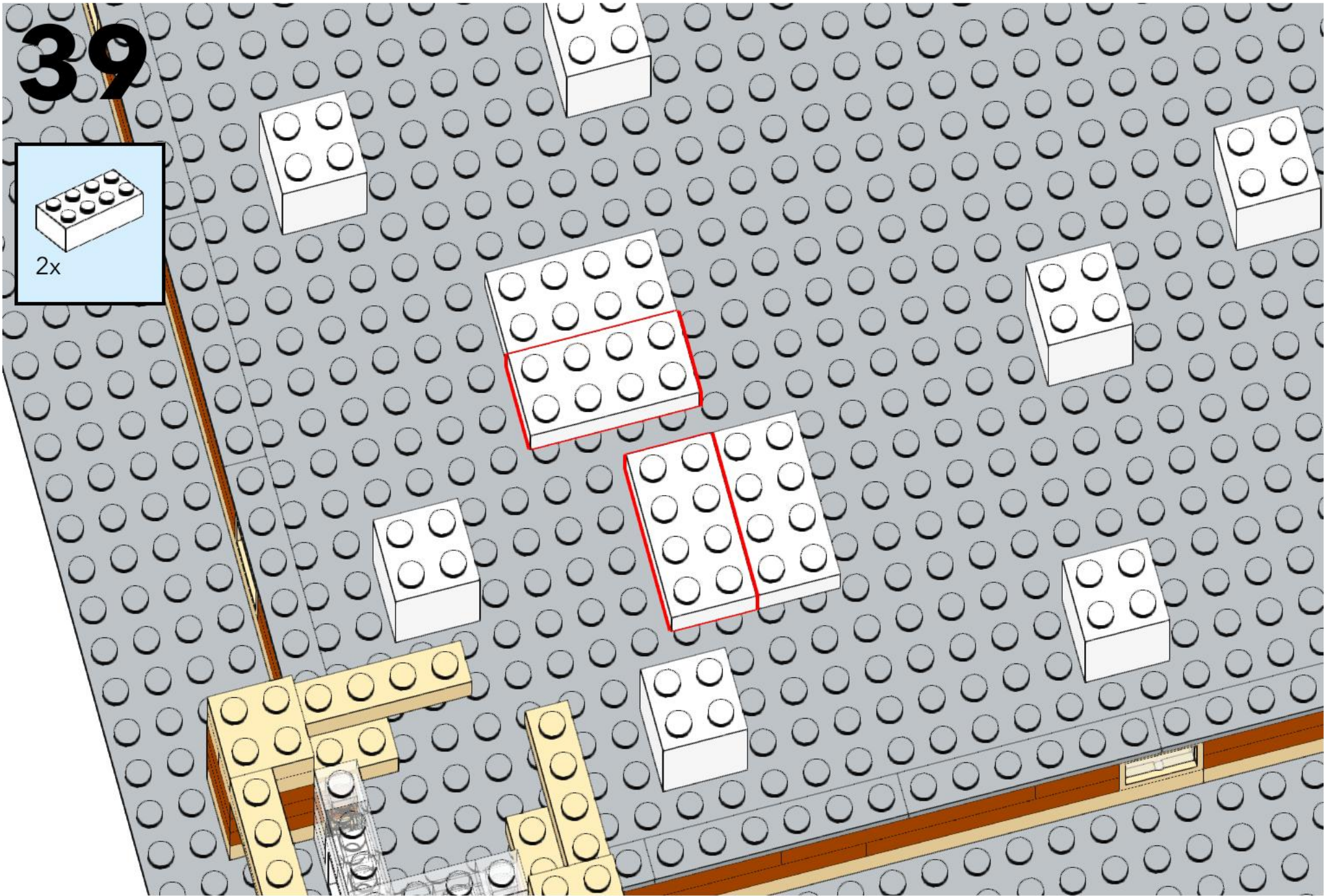
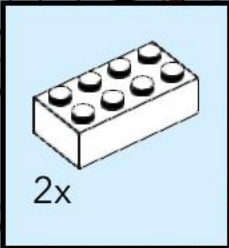



# 40

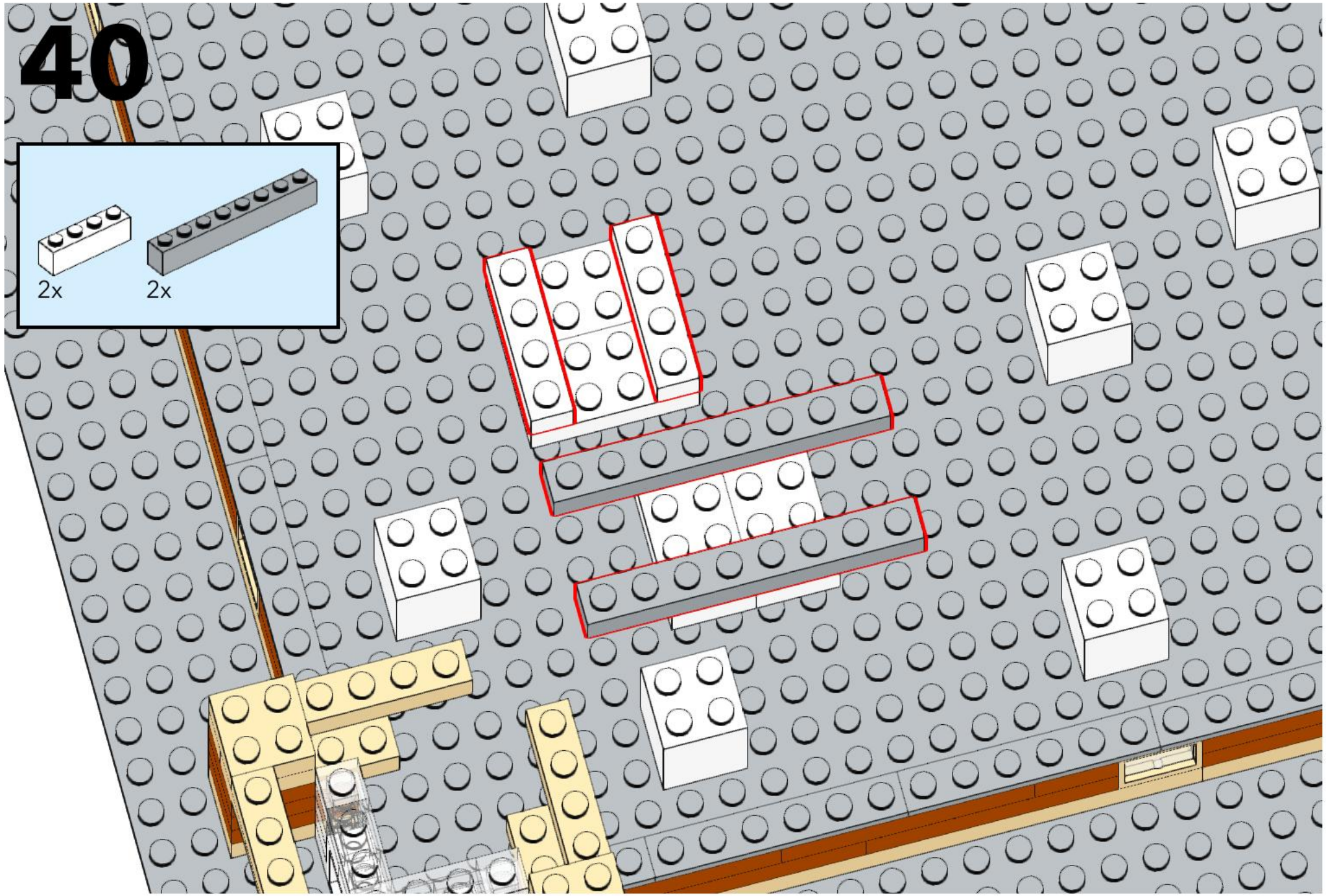
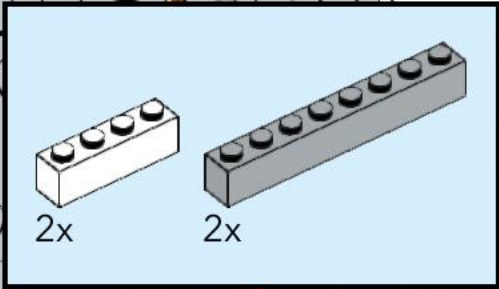

41

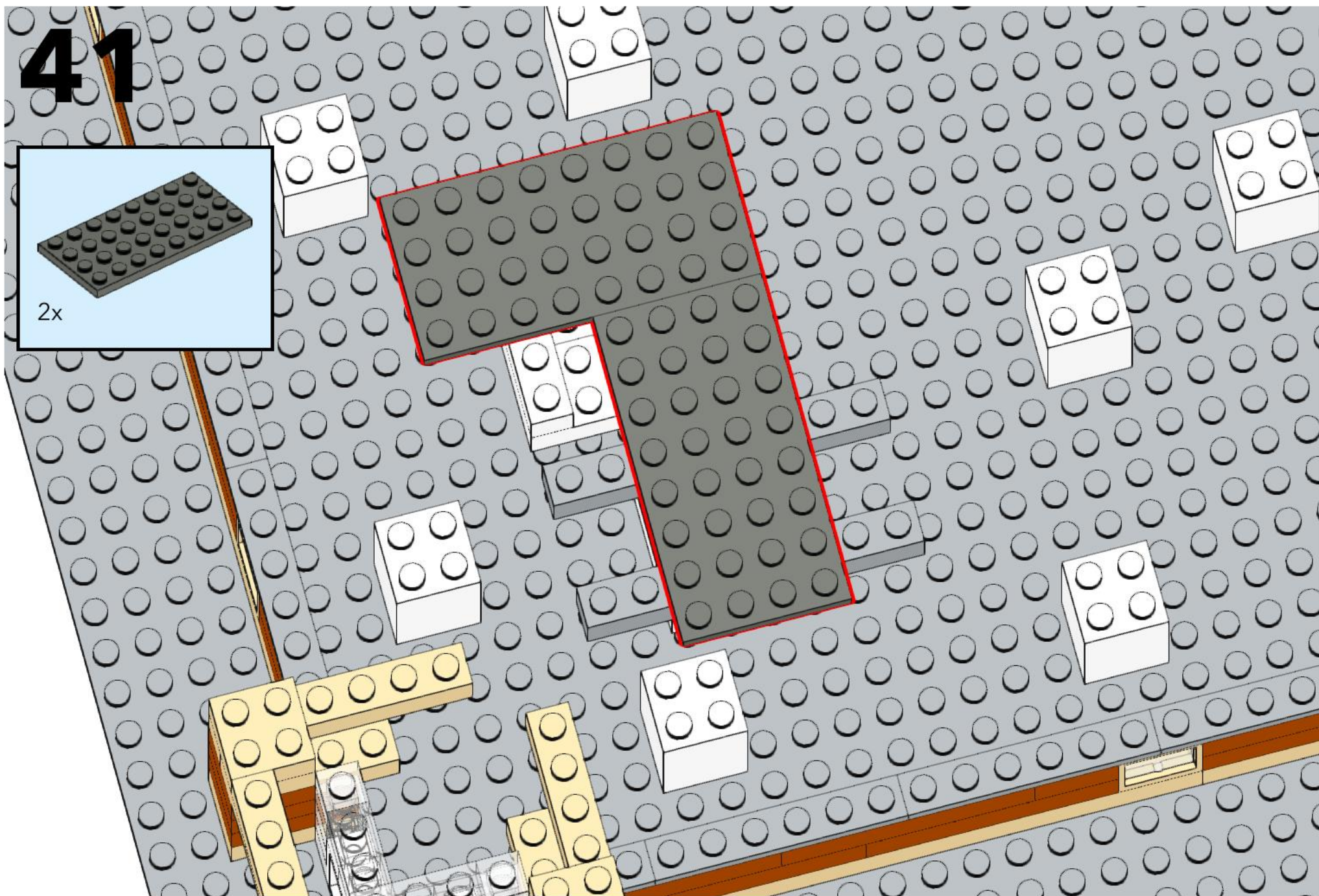

42

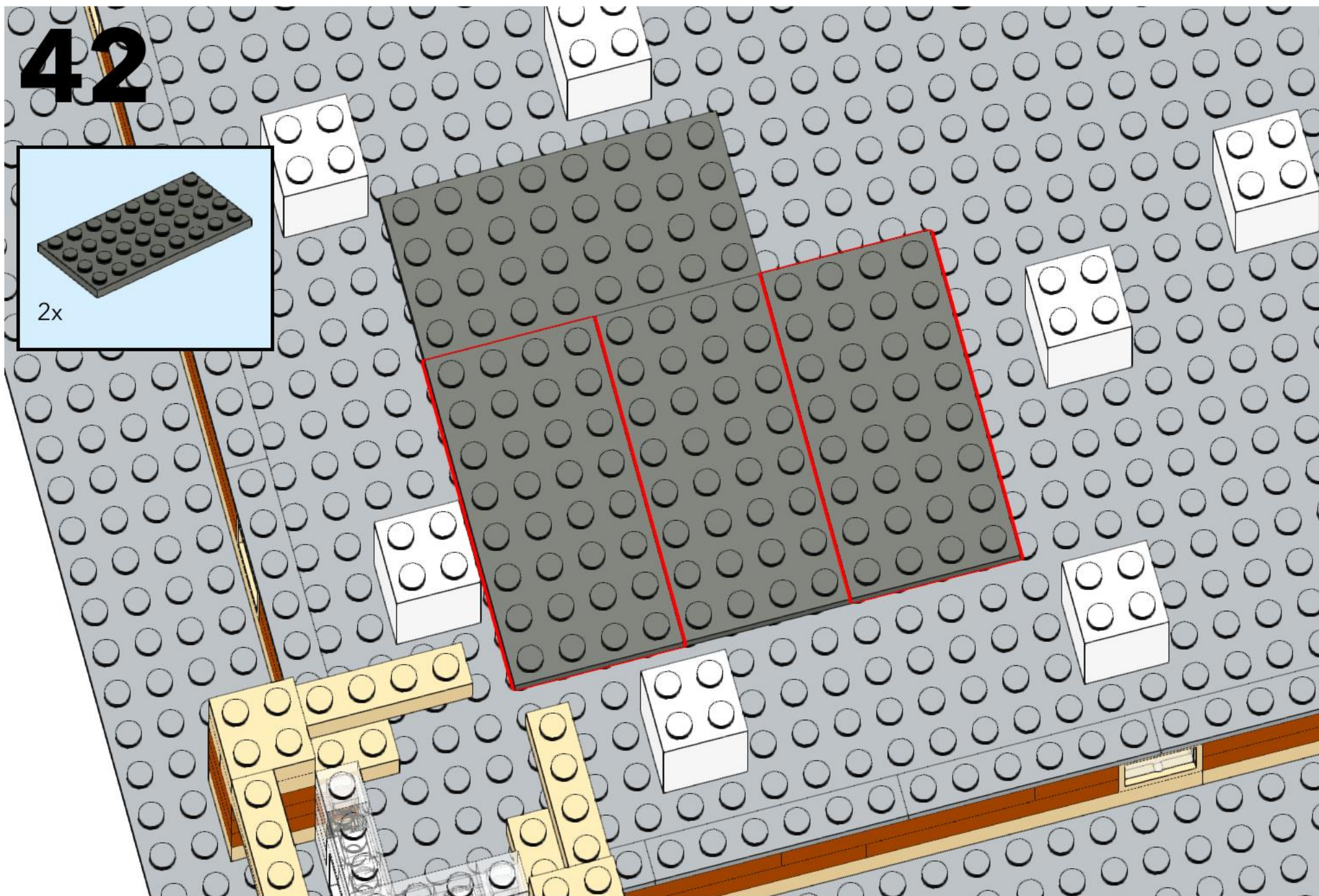

# 43

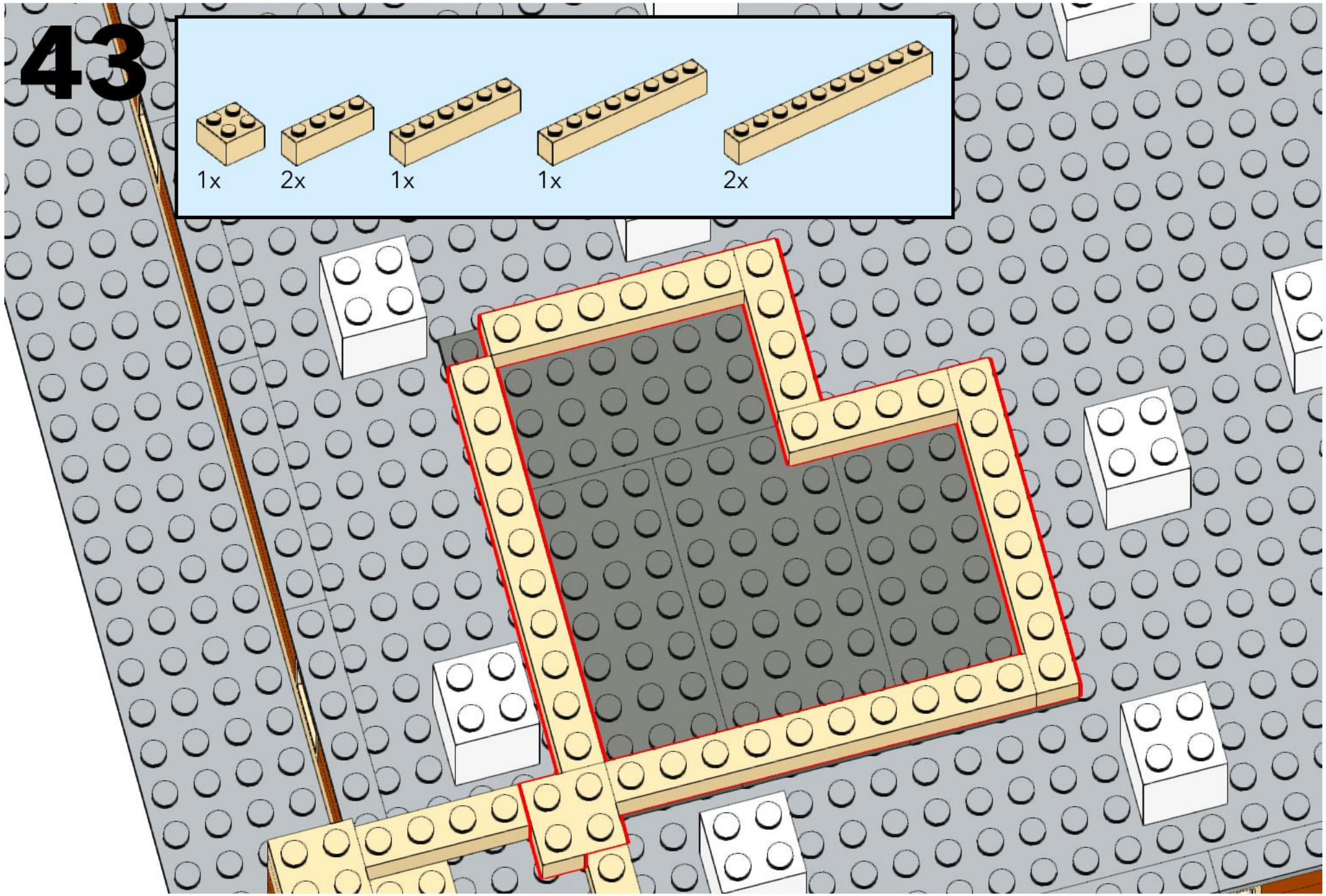
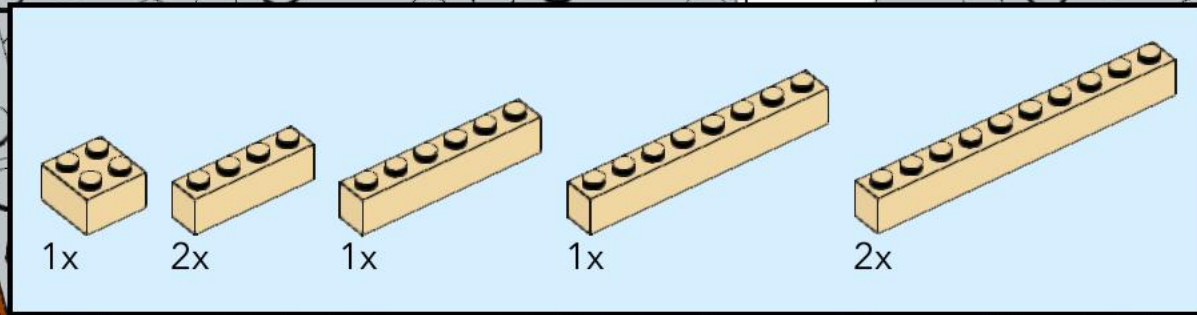

44

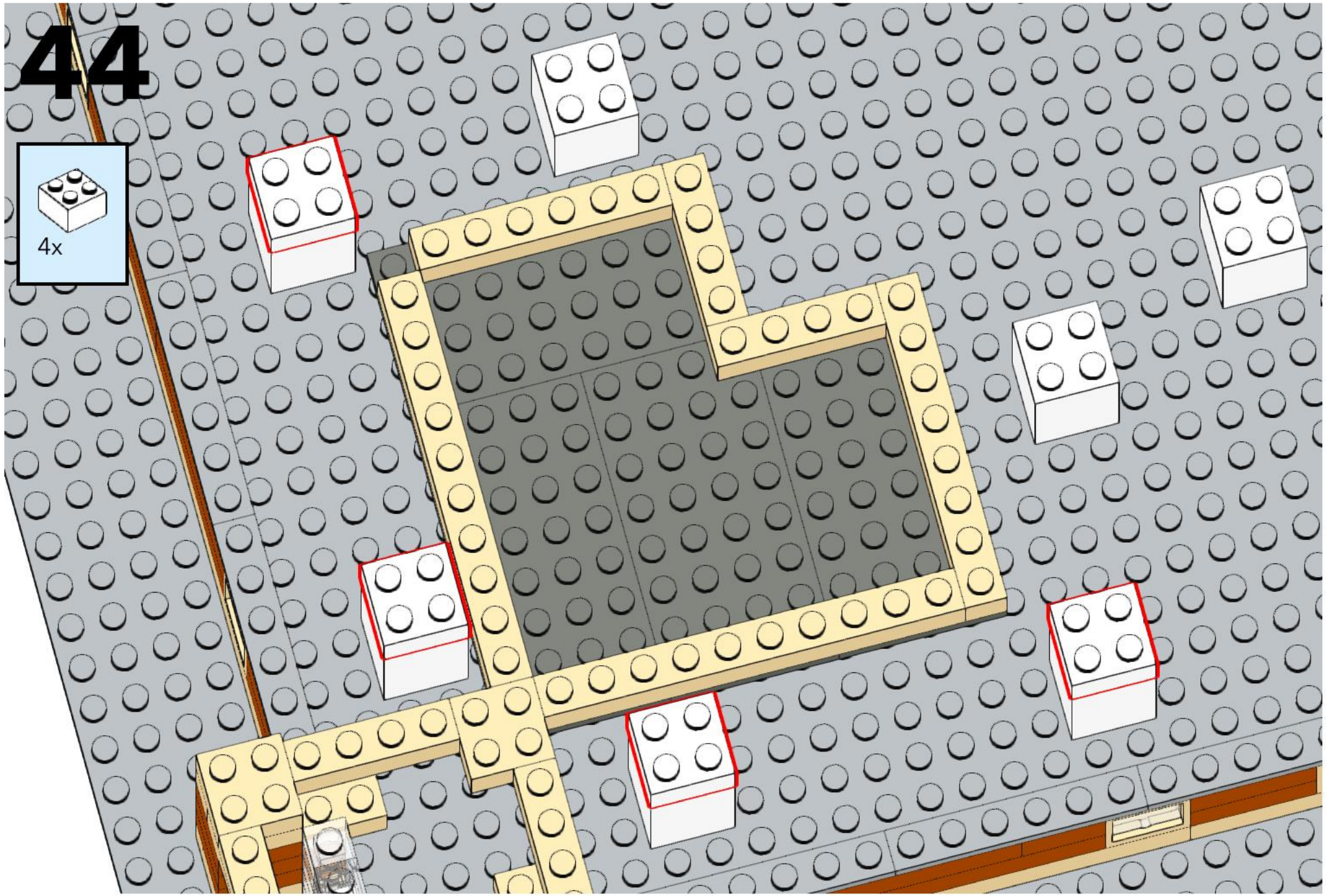

# 45

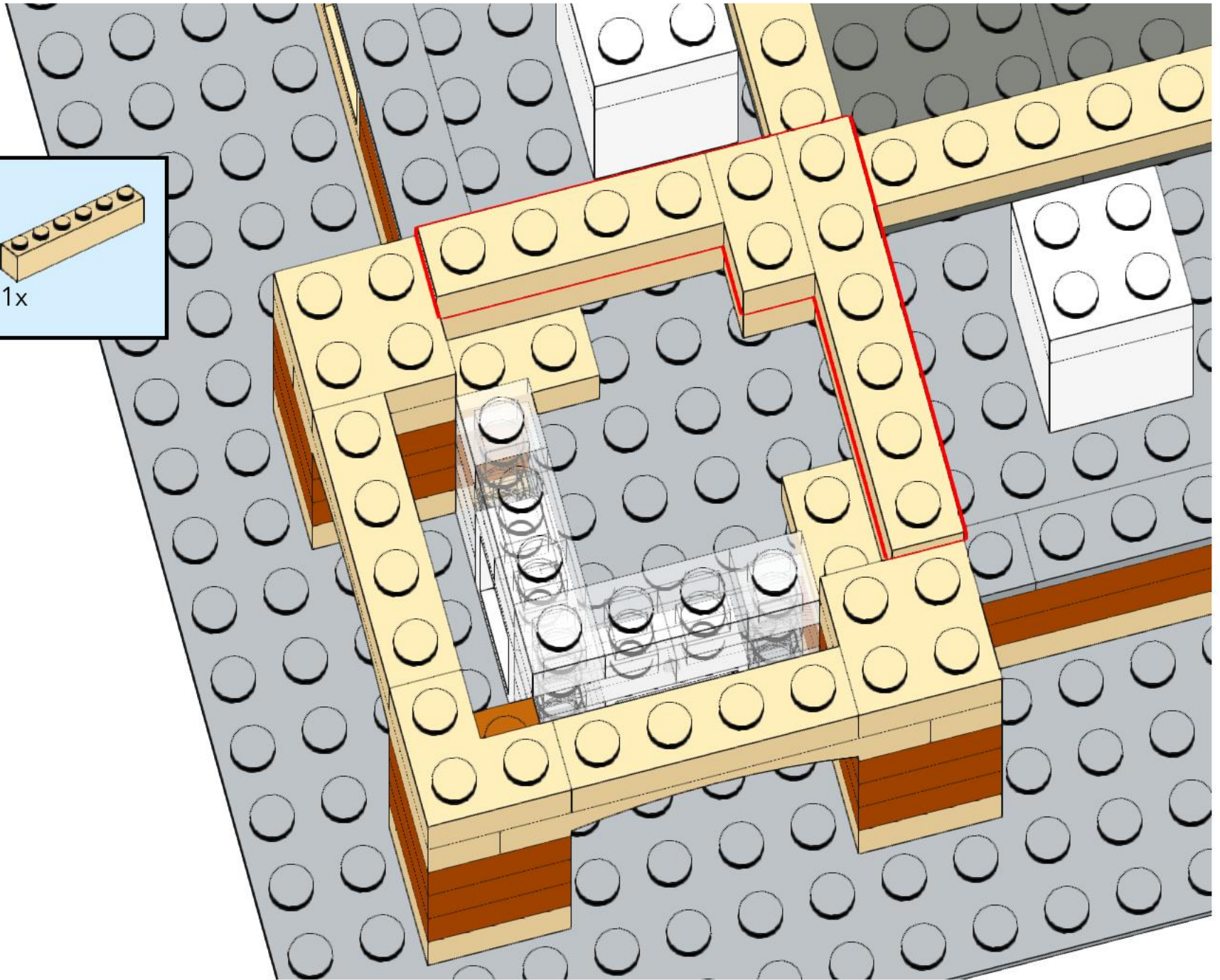
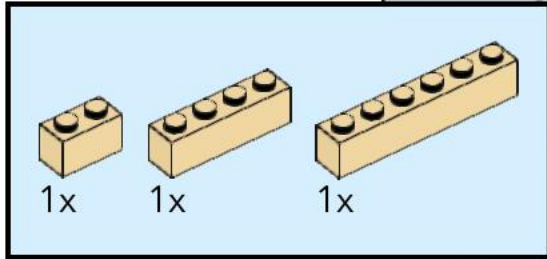

# 46

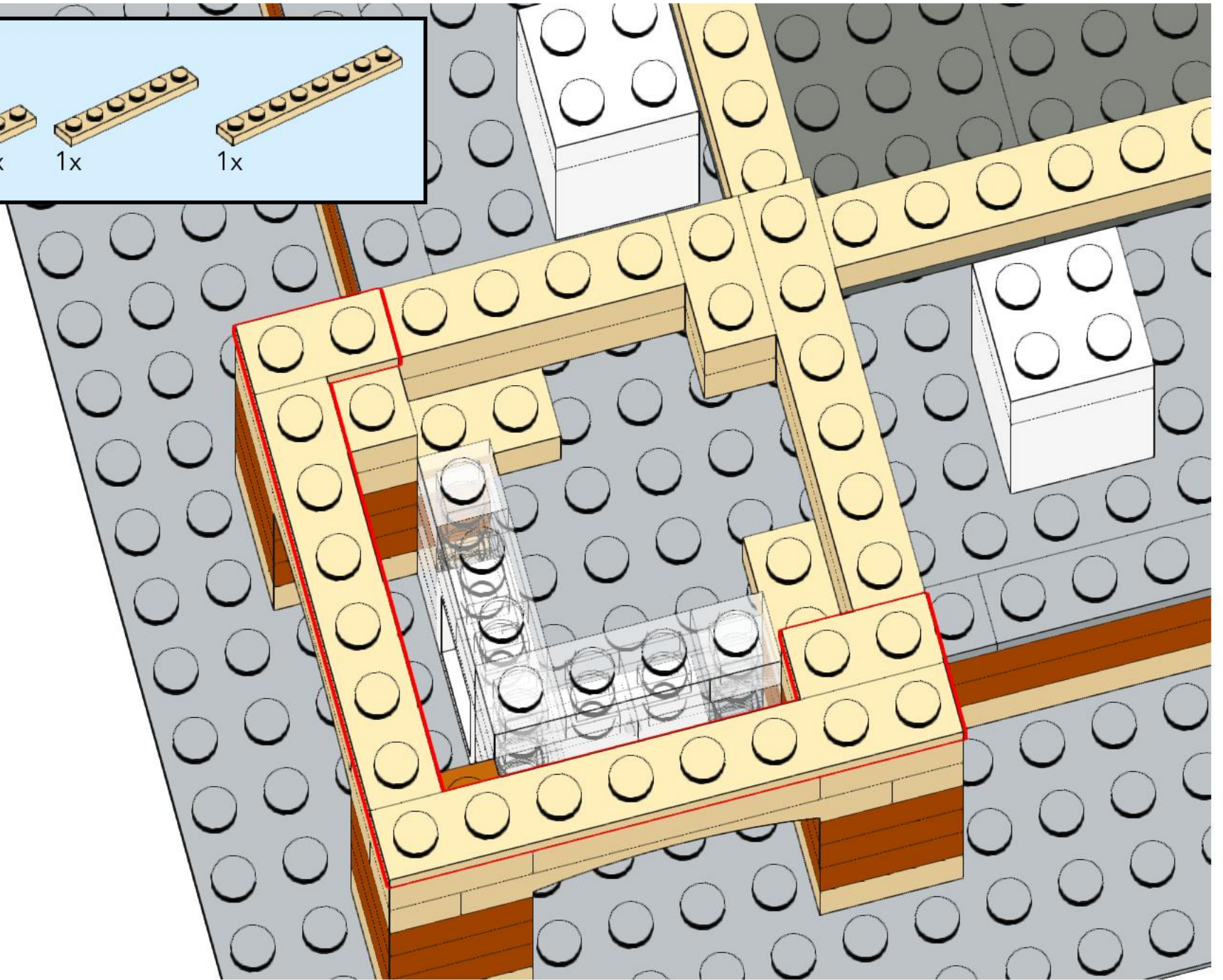
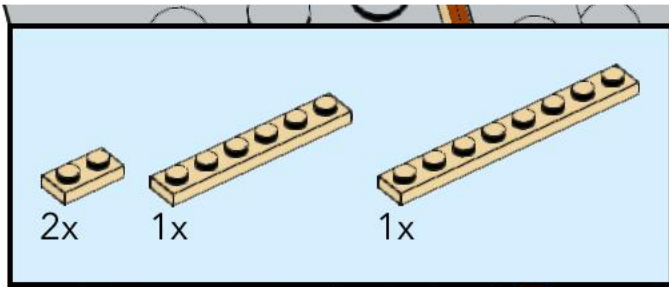



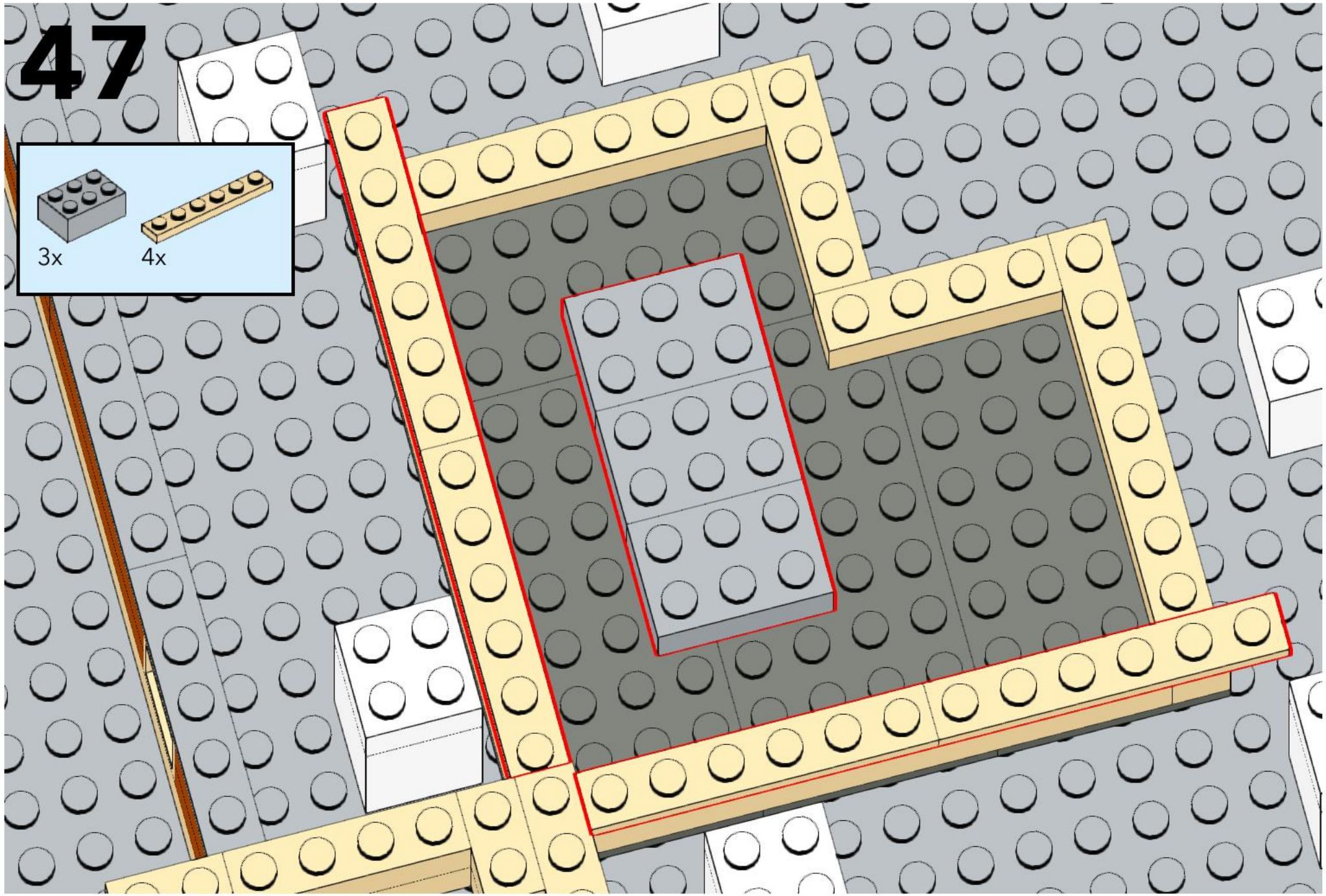
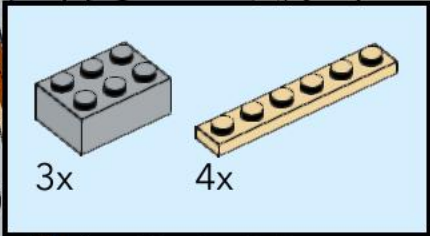

# 47



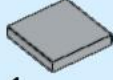

# 48

			
4x	1x	1x	1x

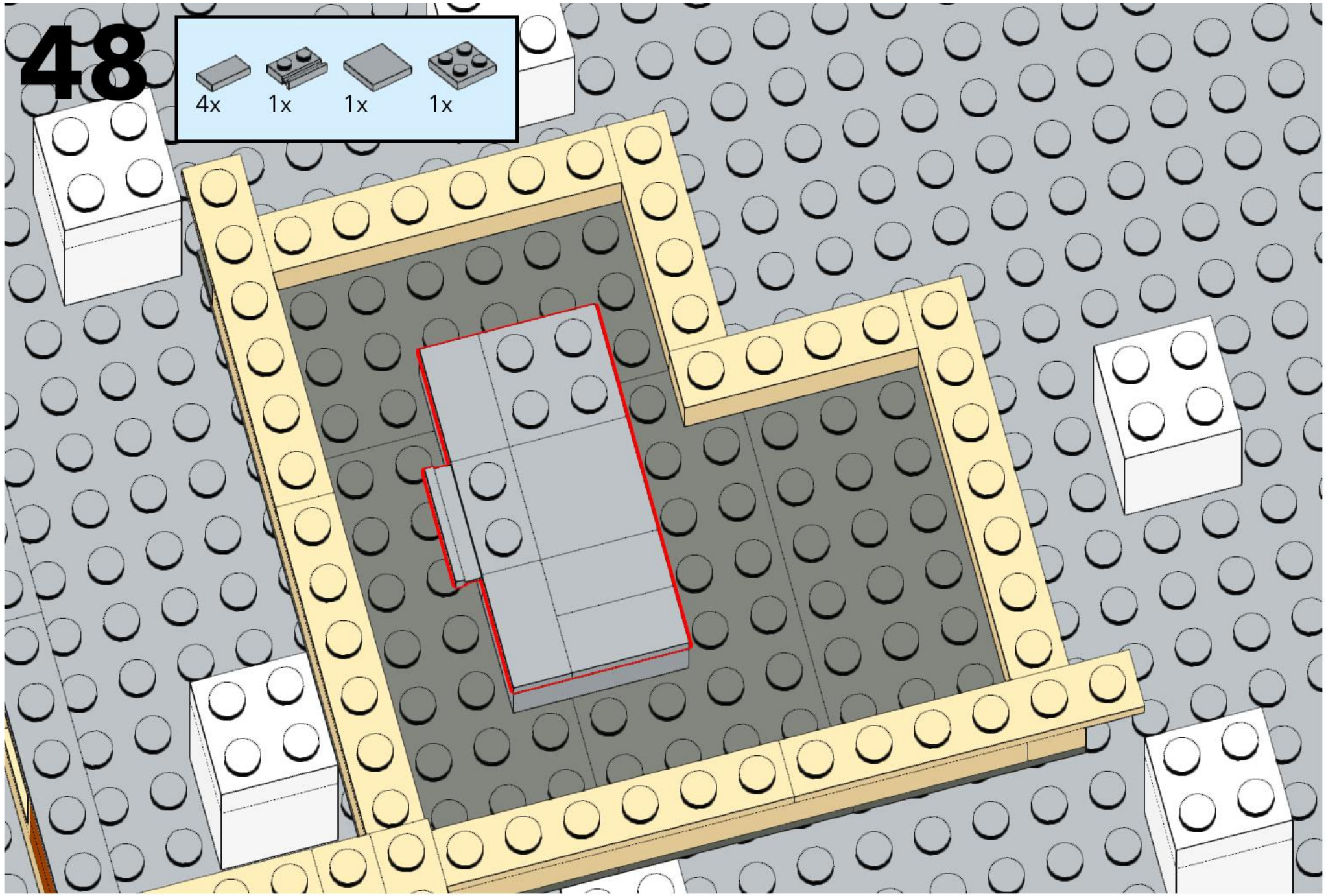

49

4x 1x

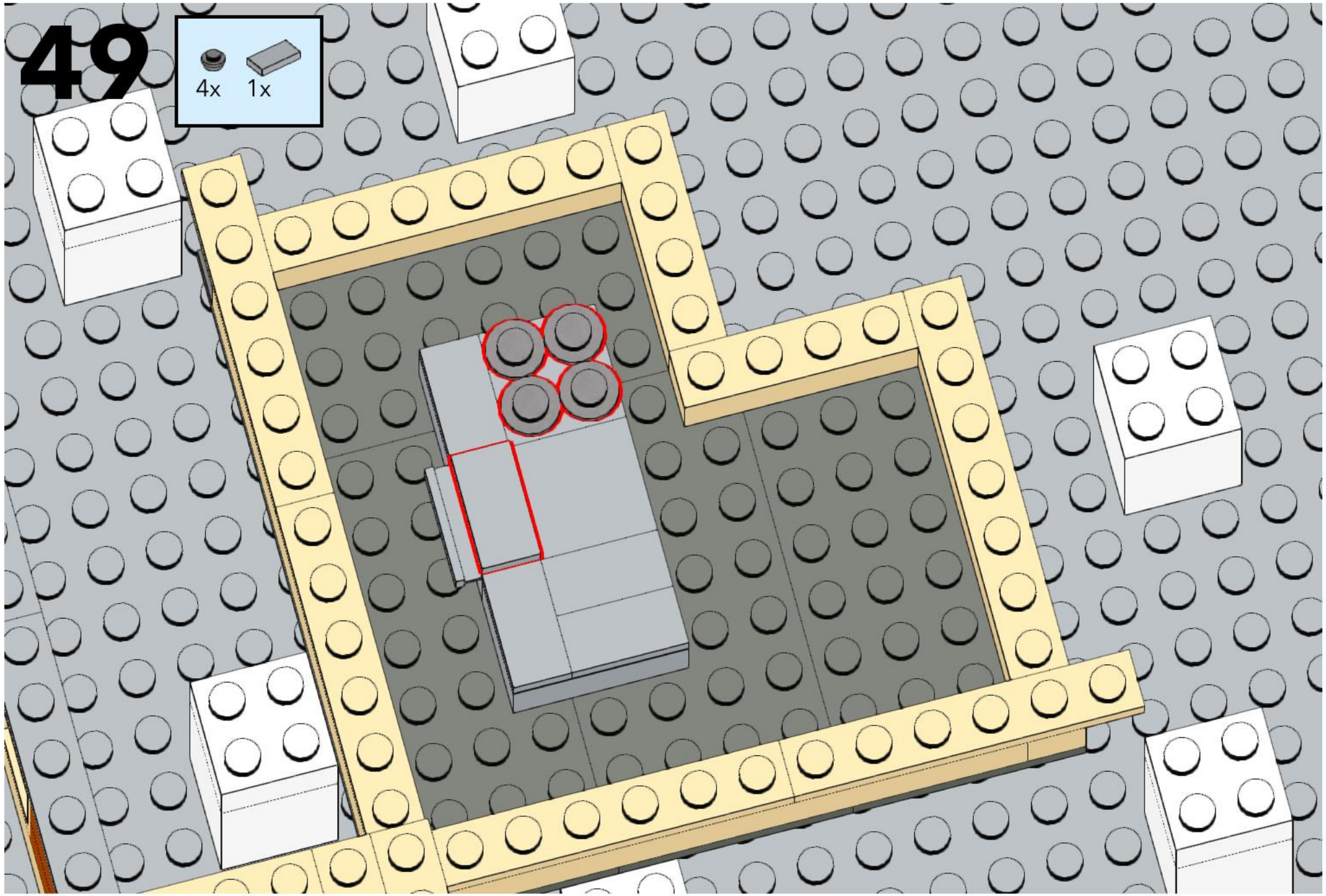
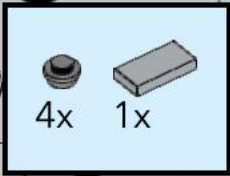

50

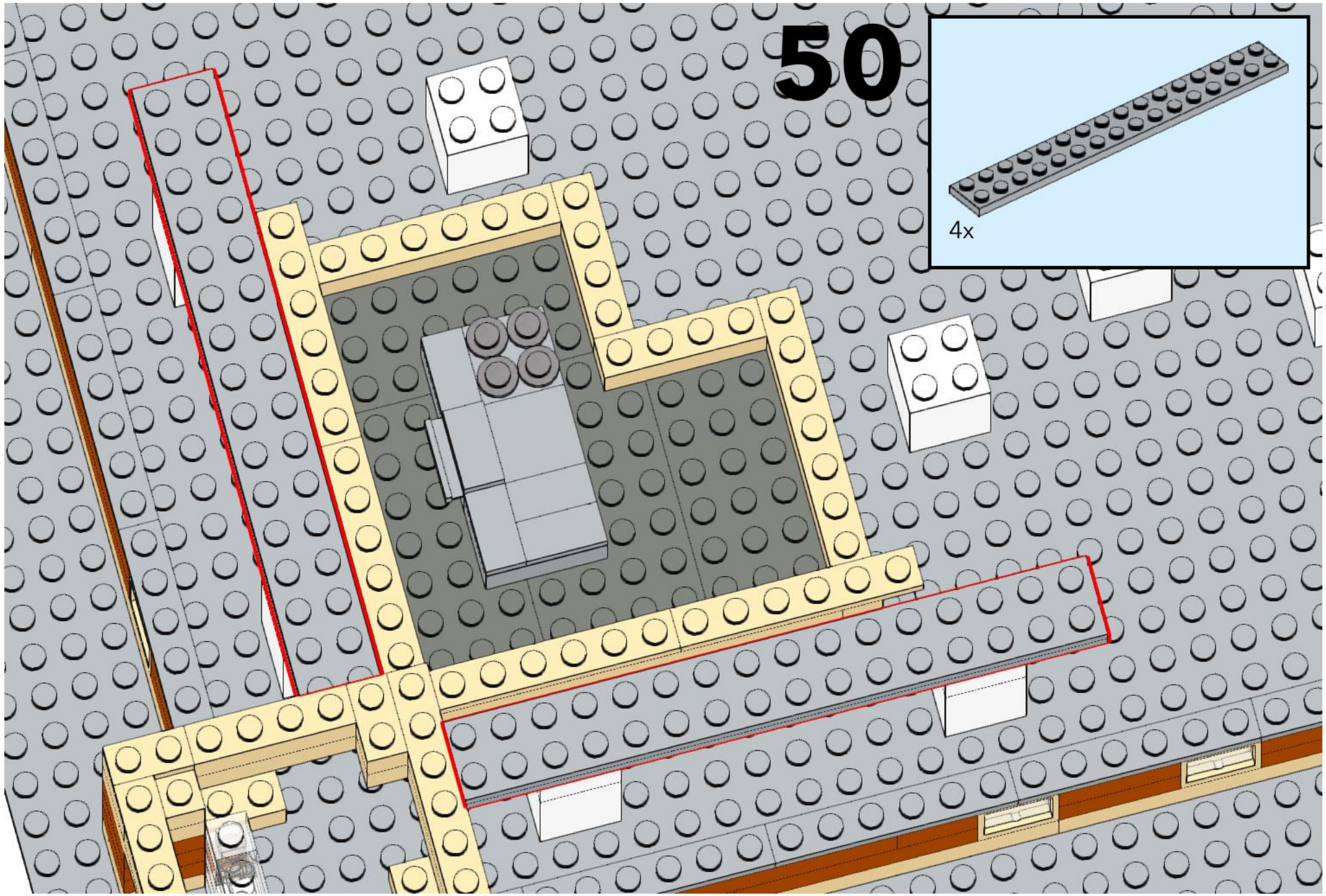
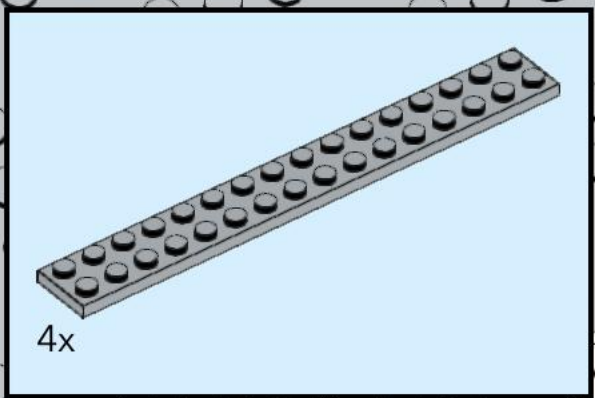

51

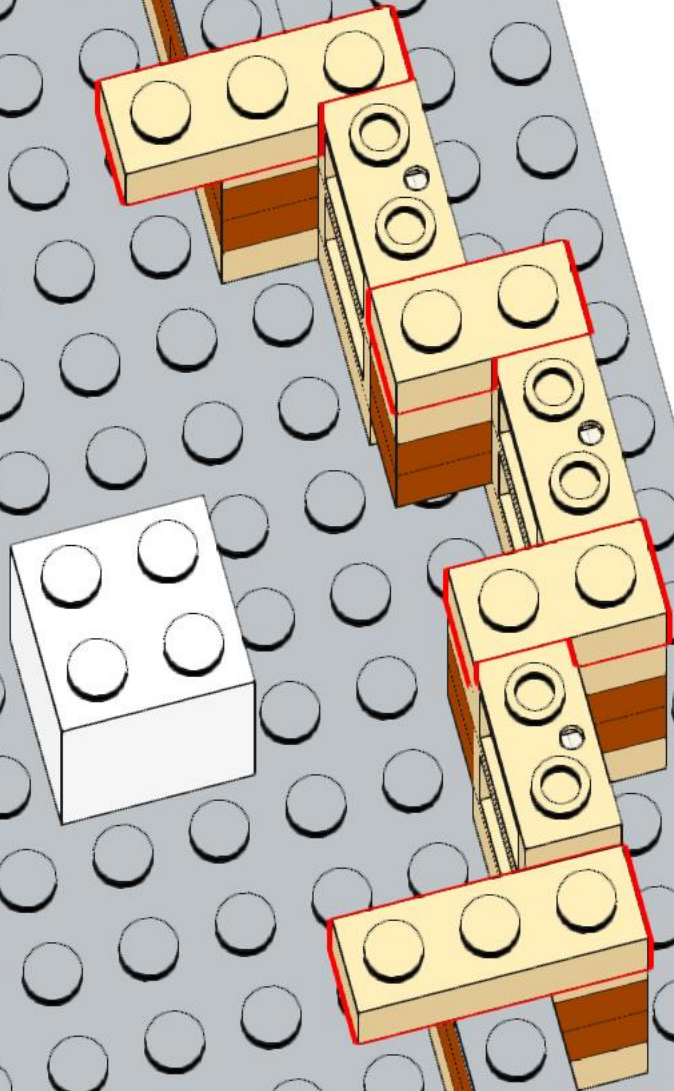
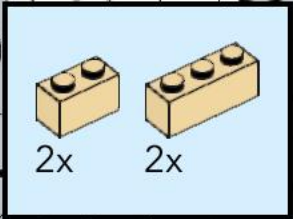

# 52

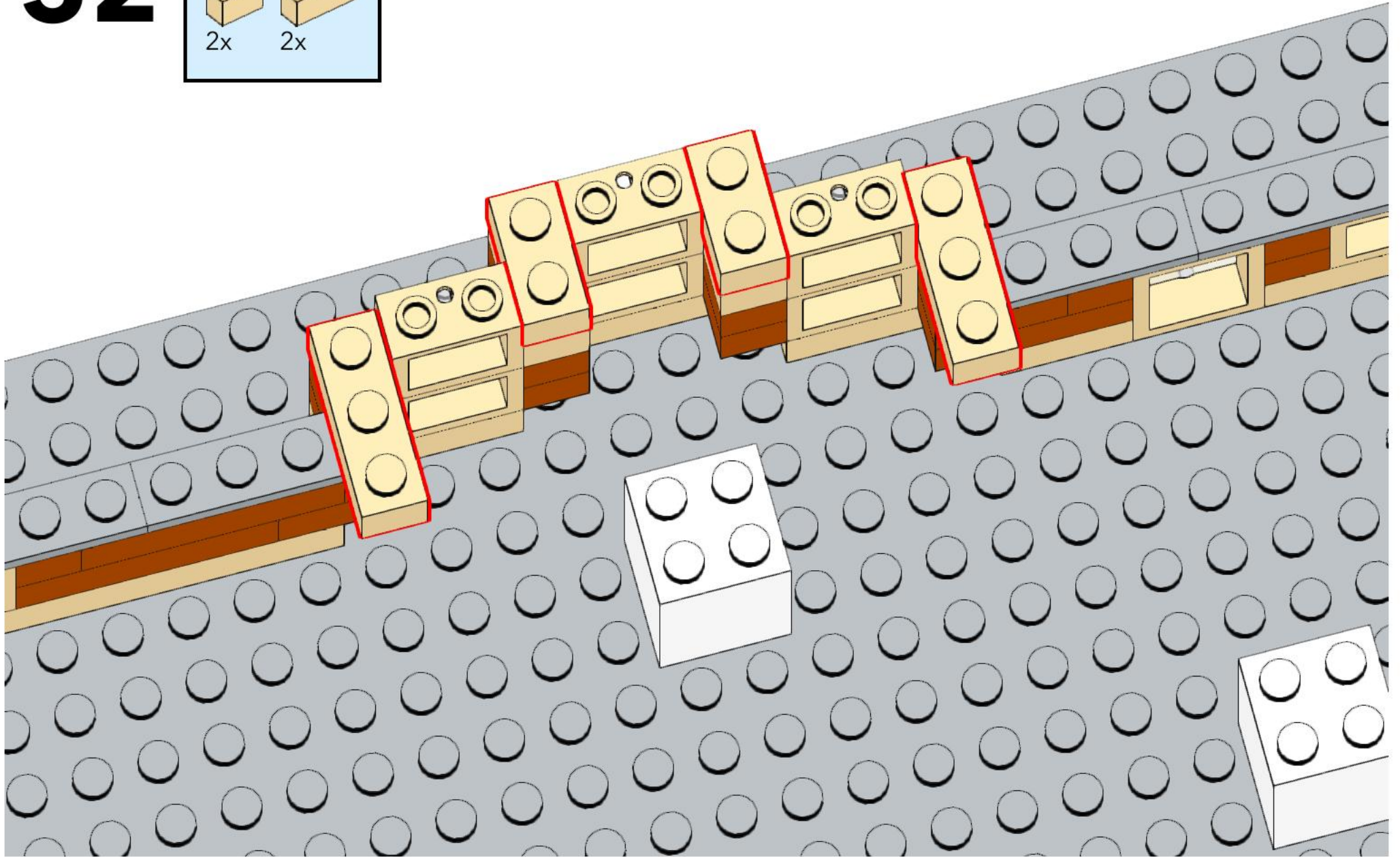
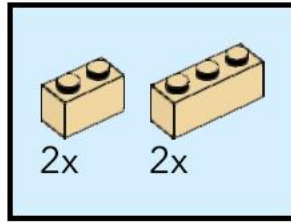

53

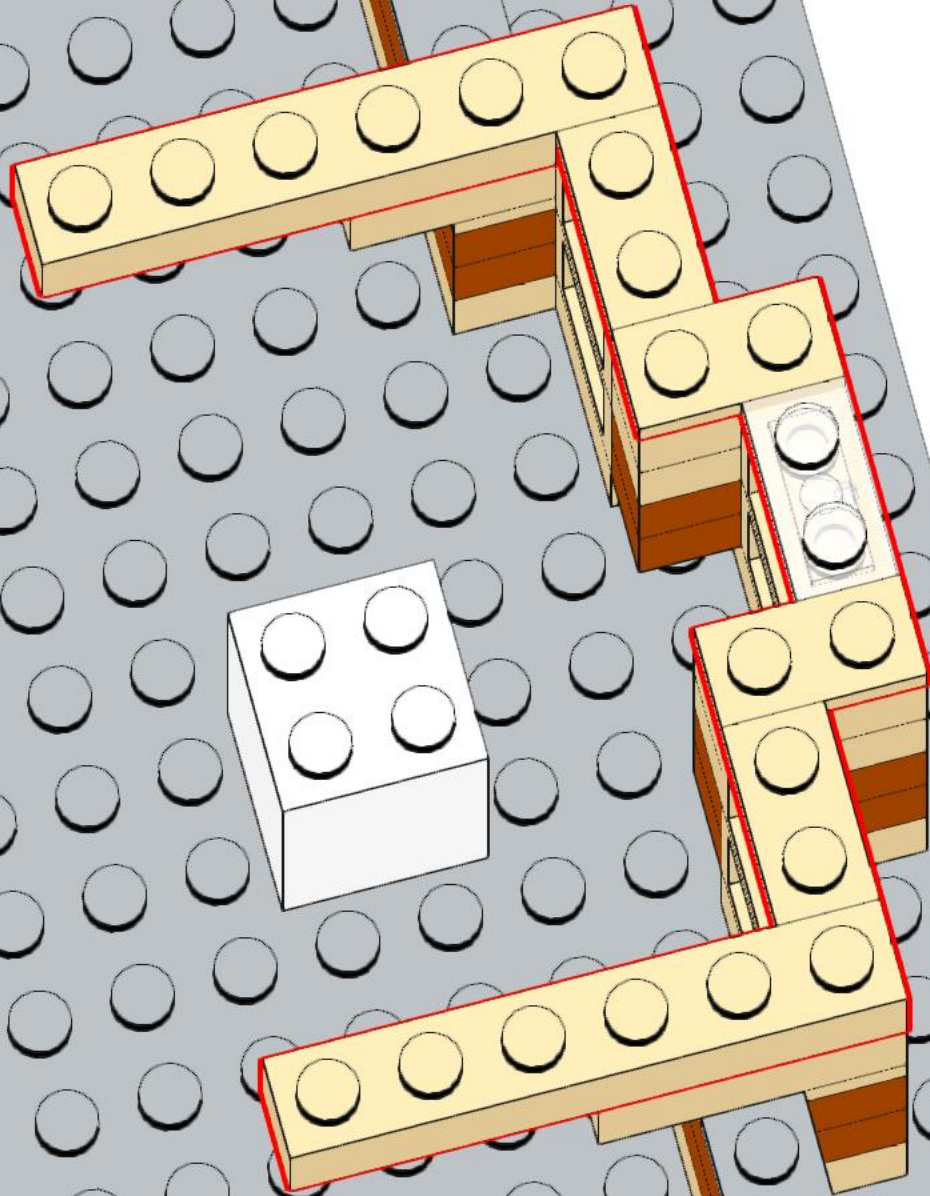
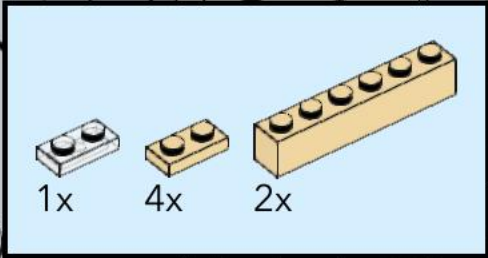

# 54

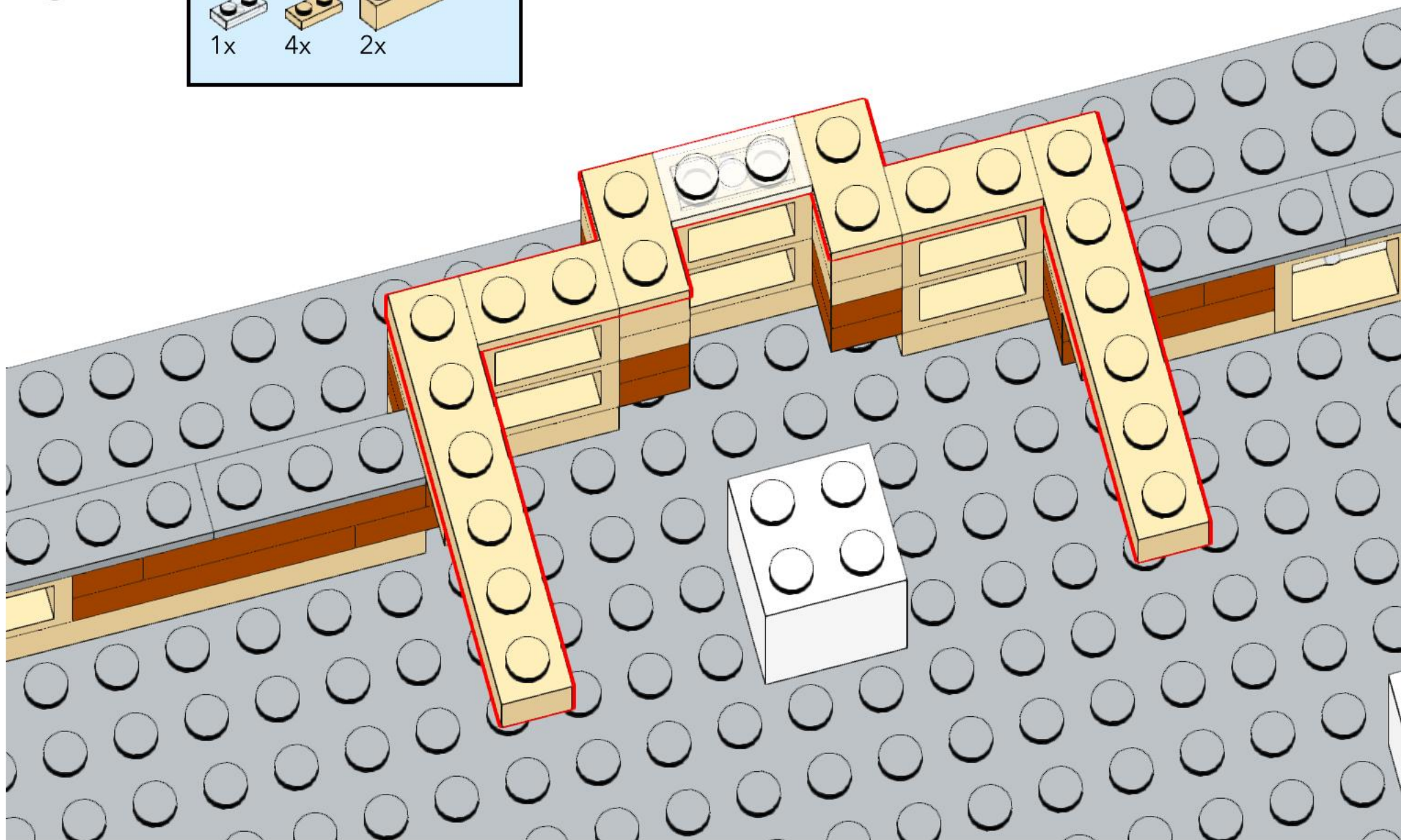
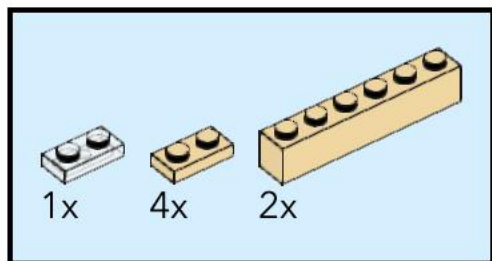

55

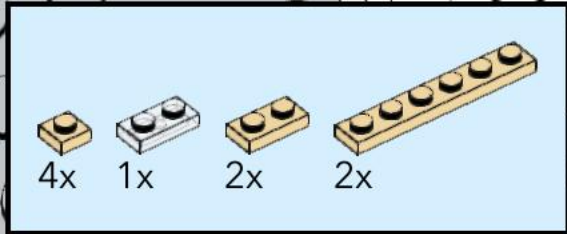

4x 1x 2x 2x

This inset box lists the required parts for step 55: 4 yellow 1x1 Technic pins, 1 white 1x2 Technic axle, 2 yellow 1x2 Technic pins, and 2 yellow 1x5 Technic Technic axles. The parts are shown with their respective quantities.

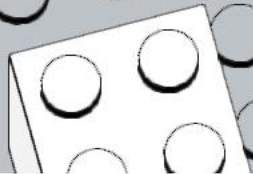
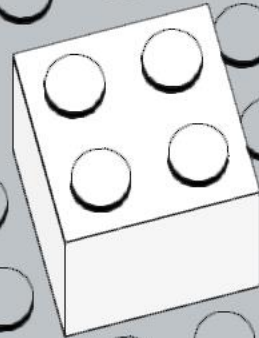
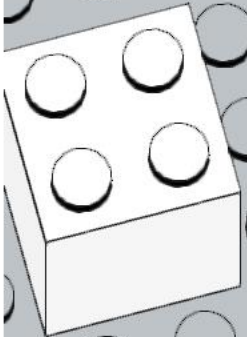
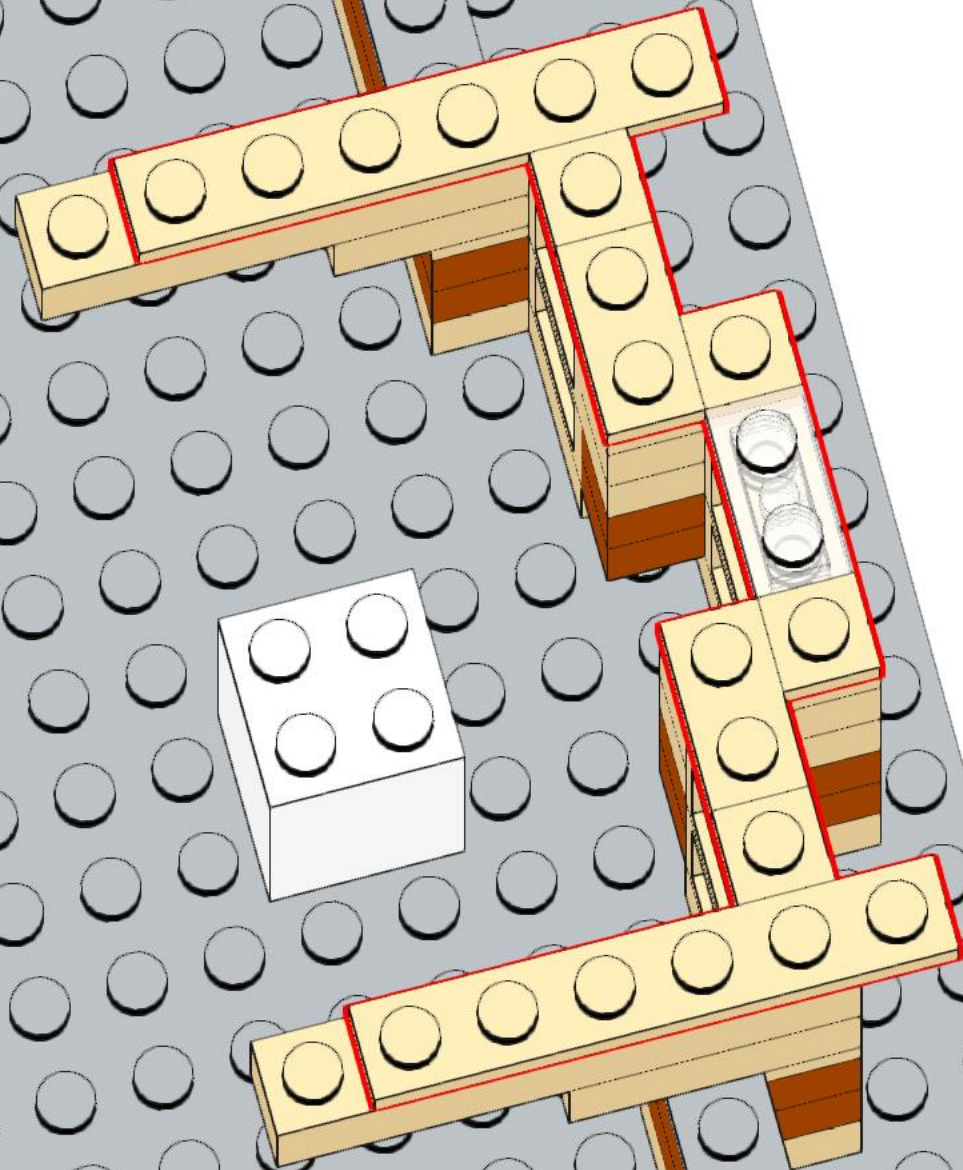



56

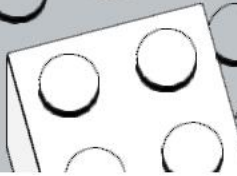
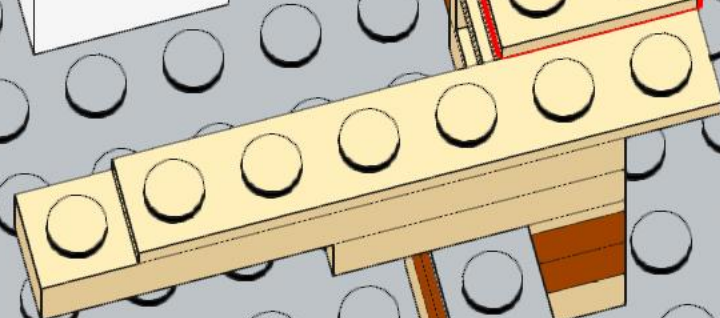
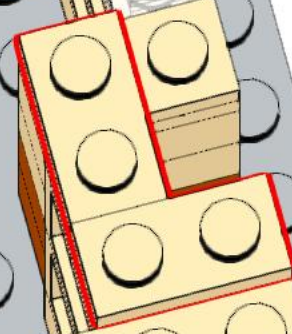
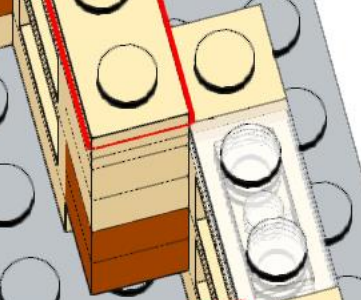
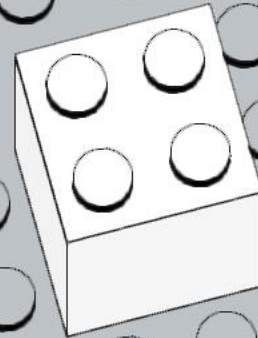
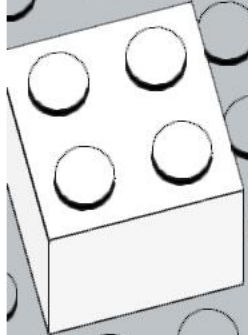
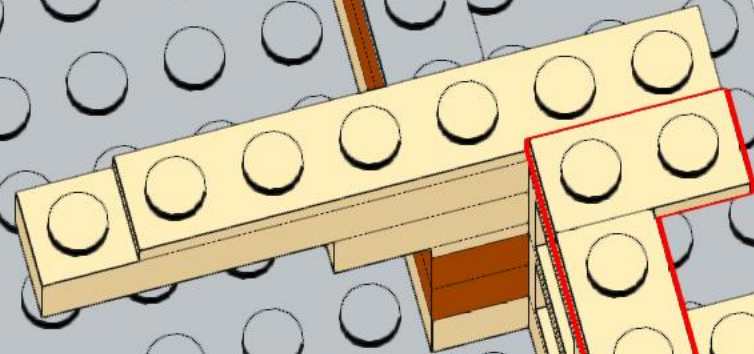
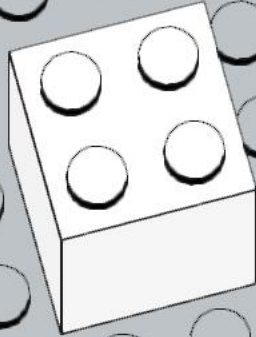
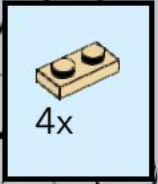

57

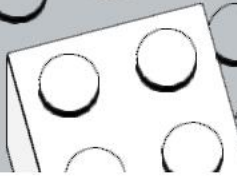
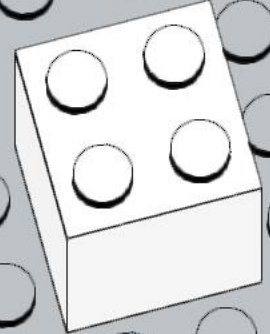
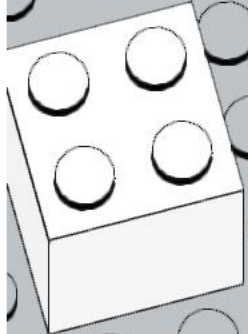
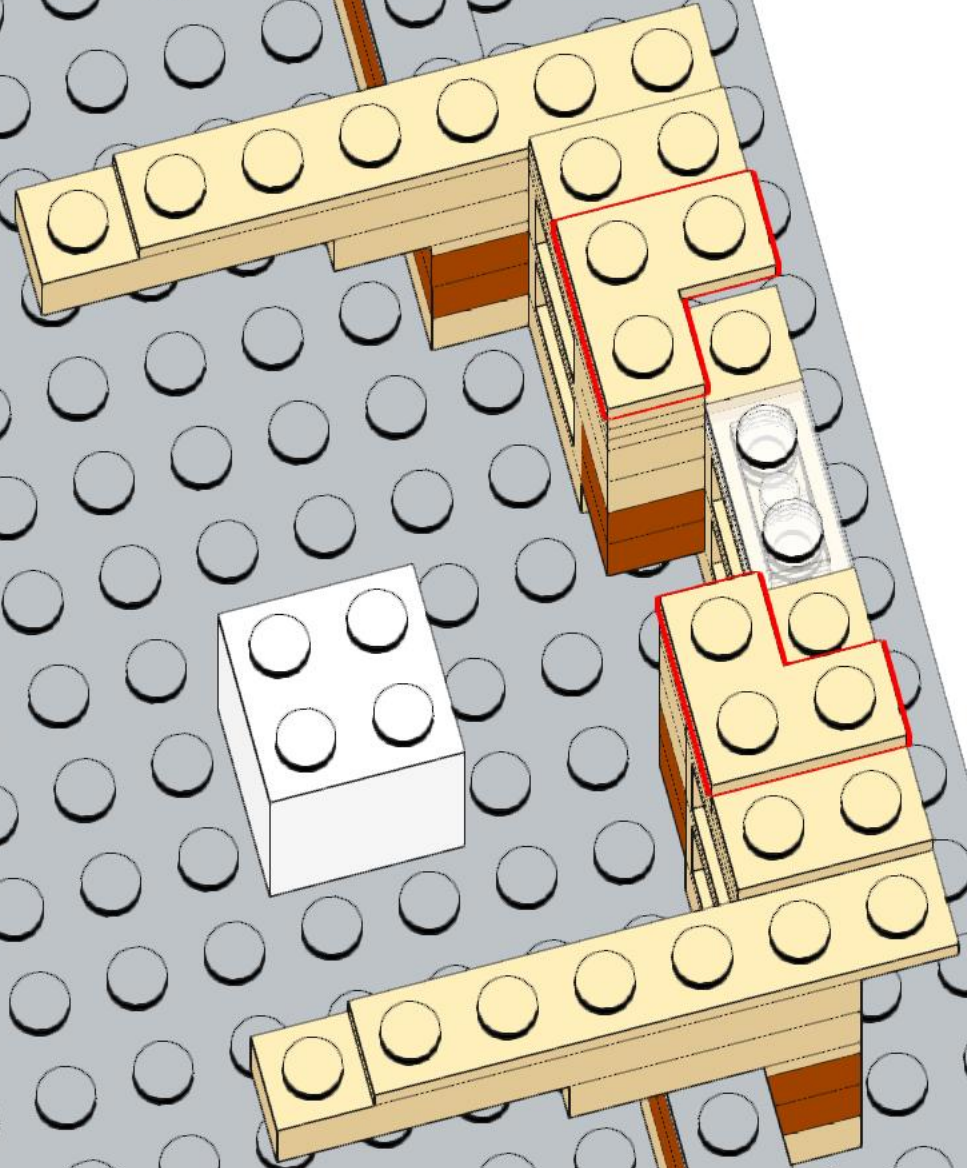
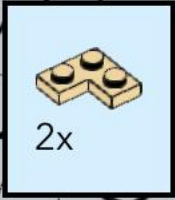

# 58

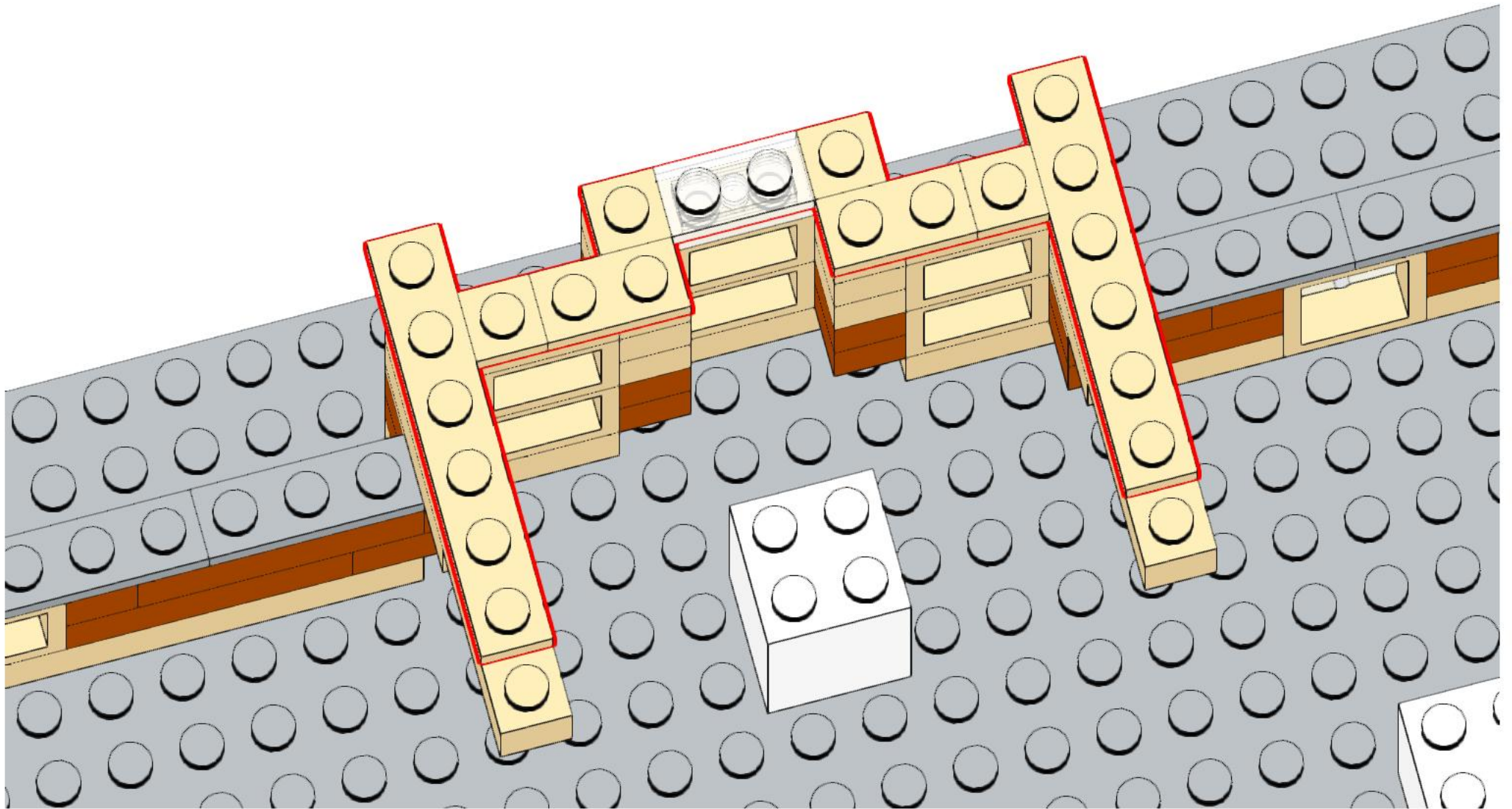
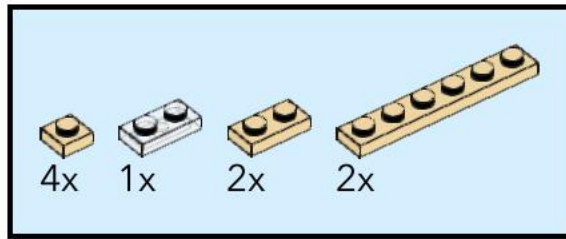

# 59

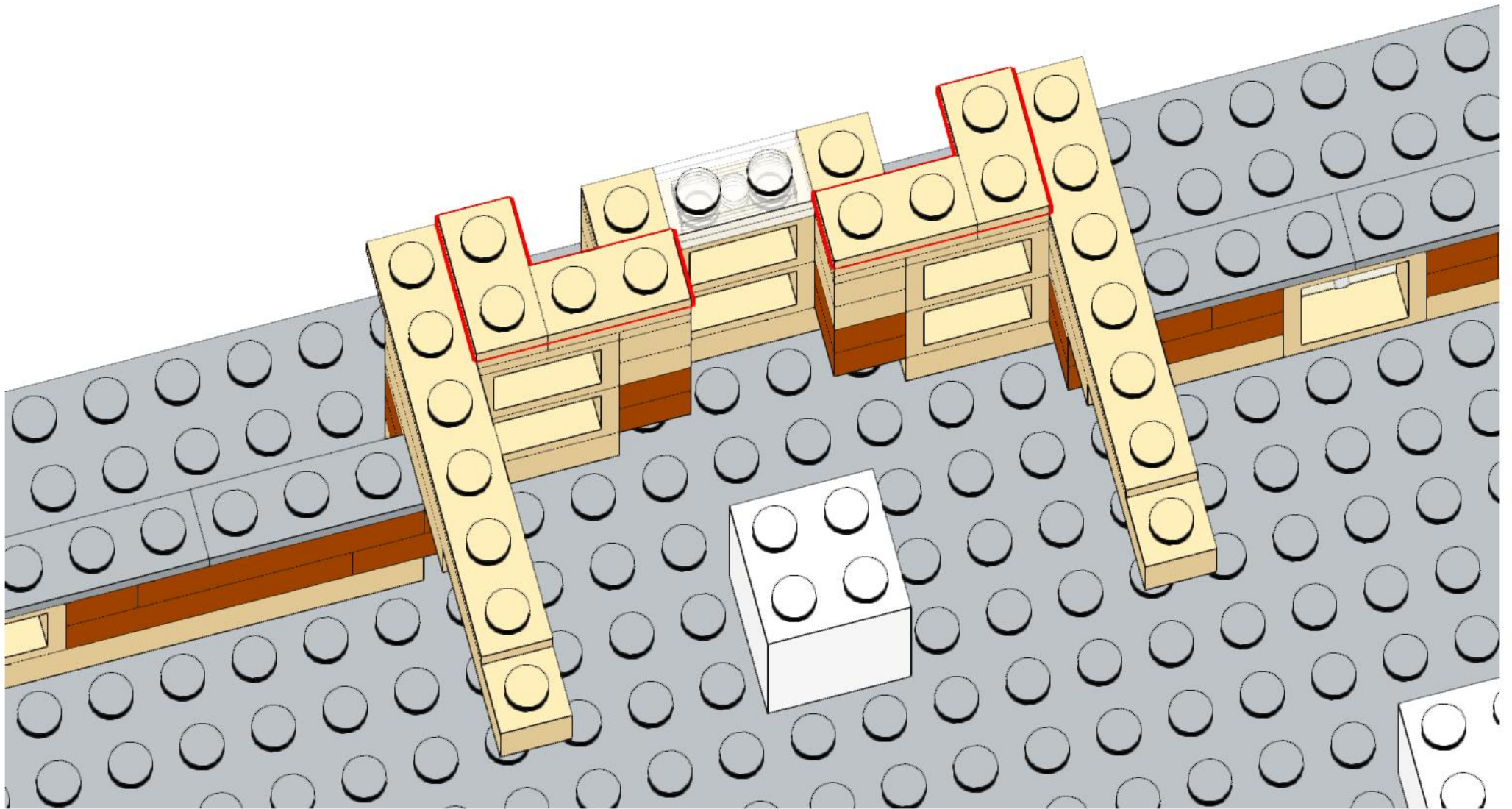
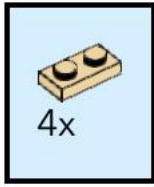

# 60

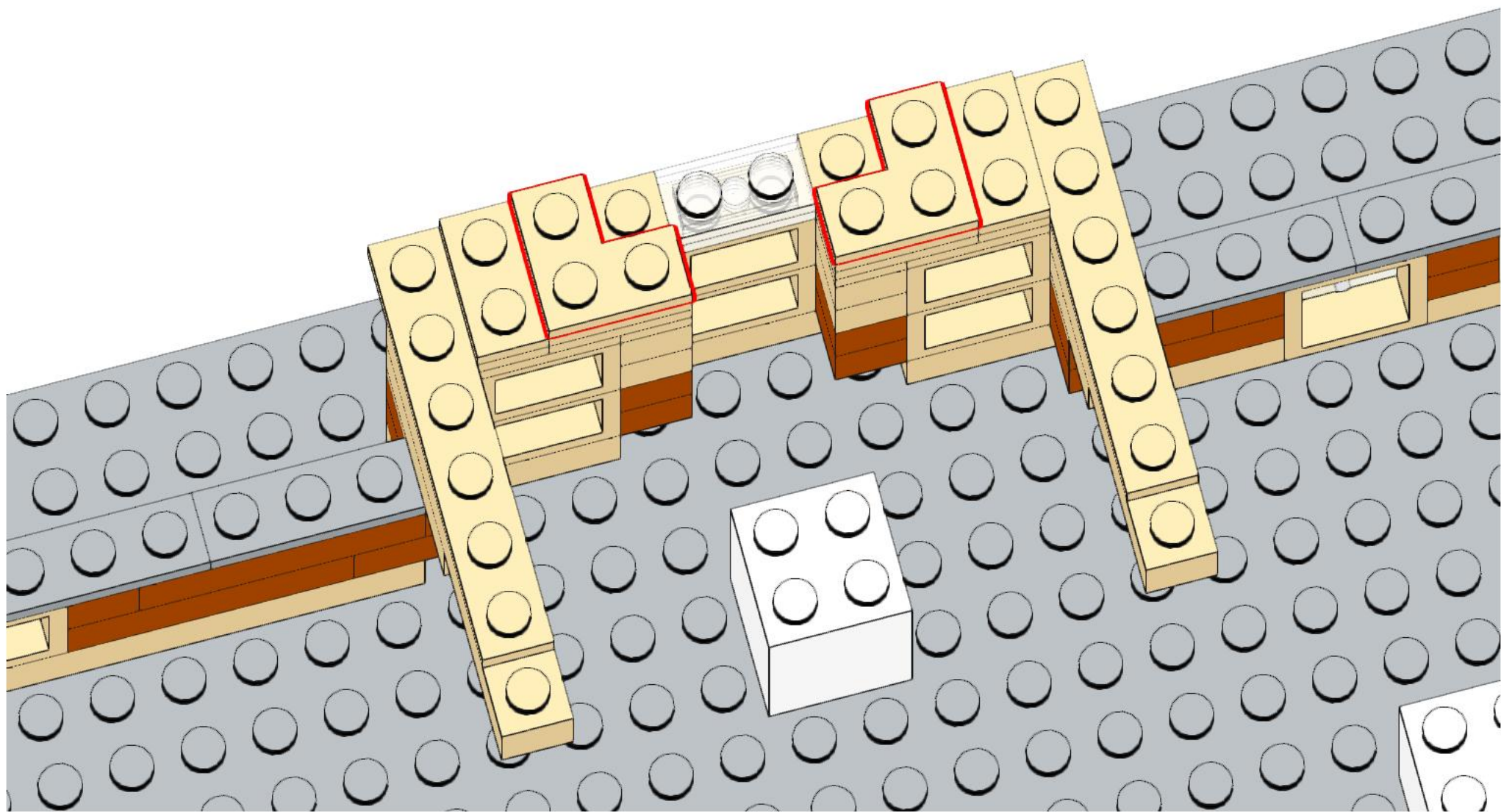
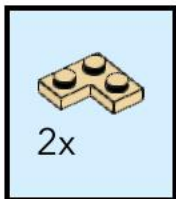

# 61

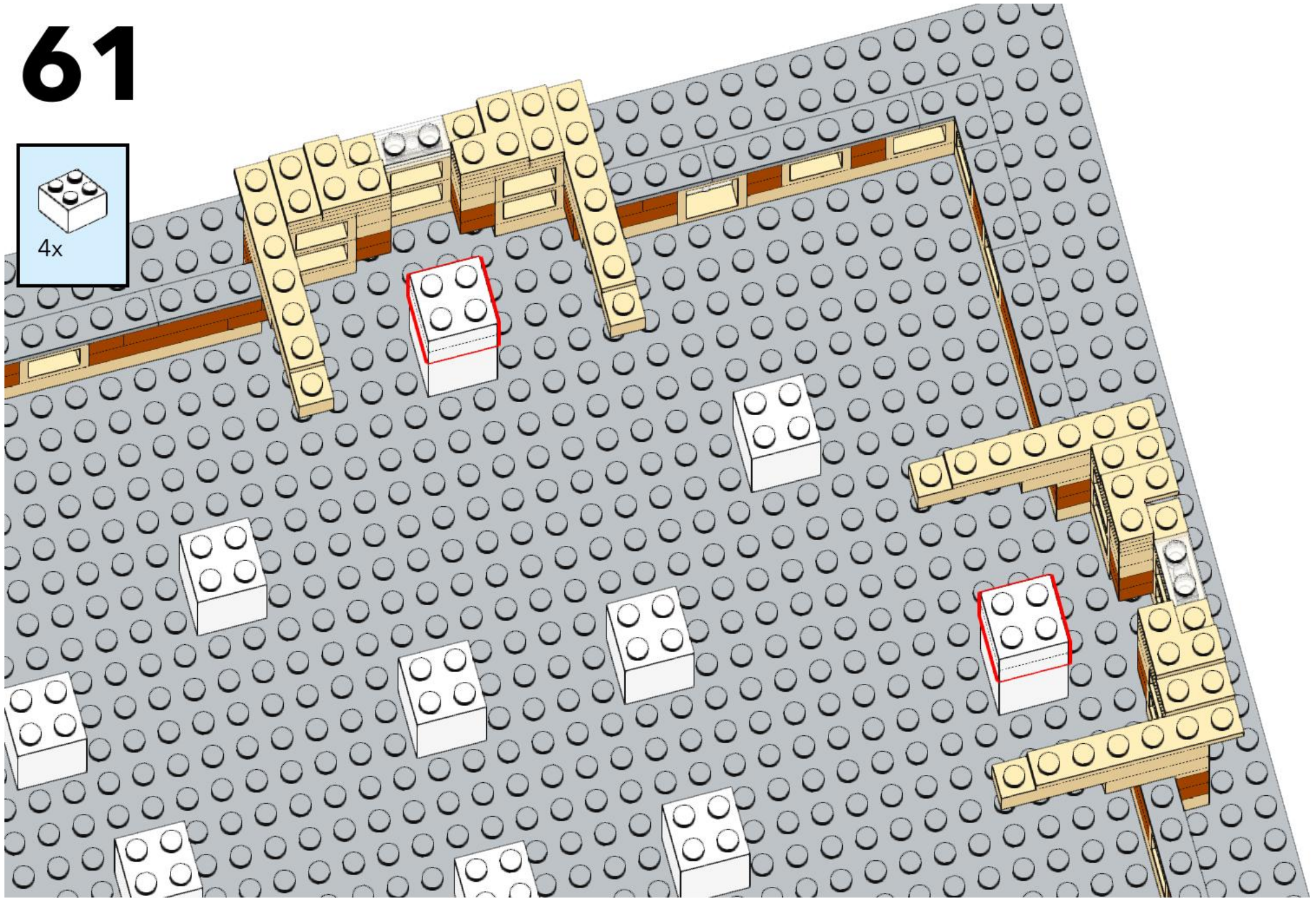
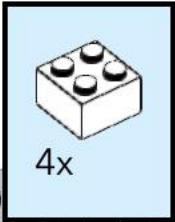

# 62

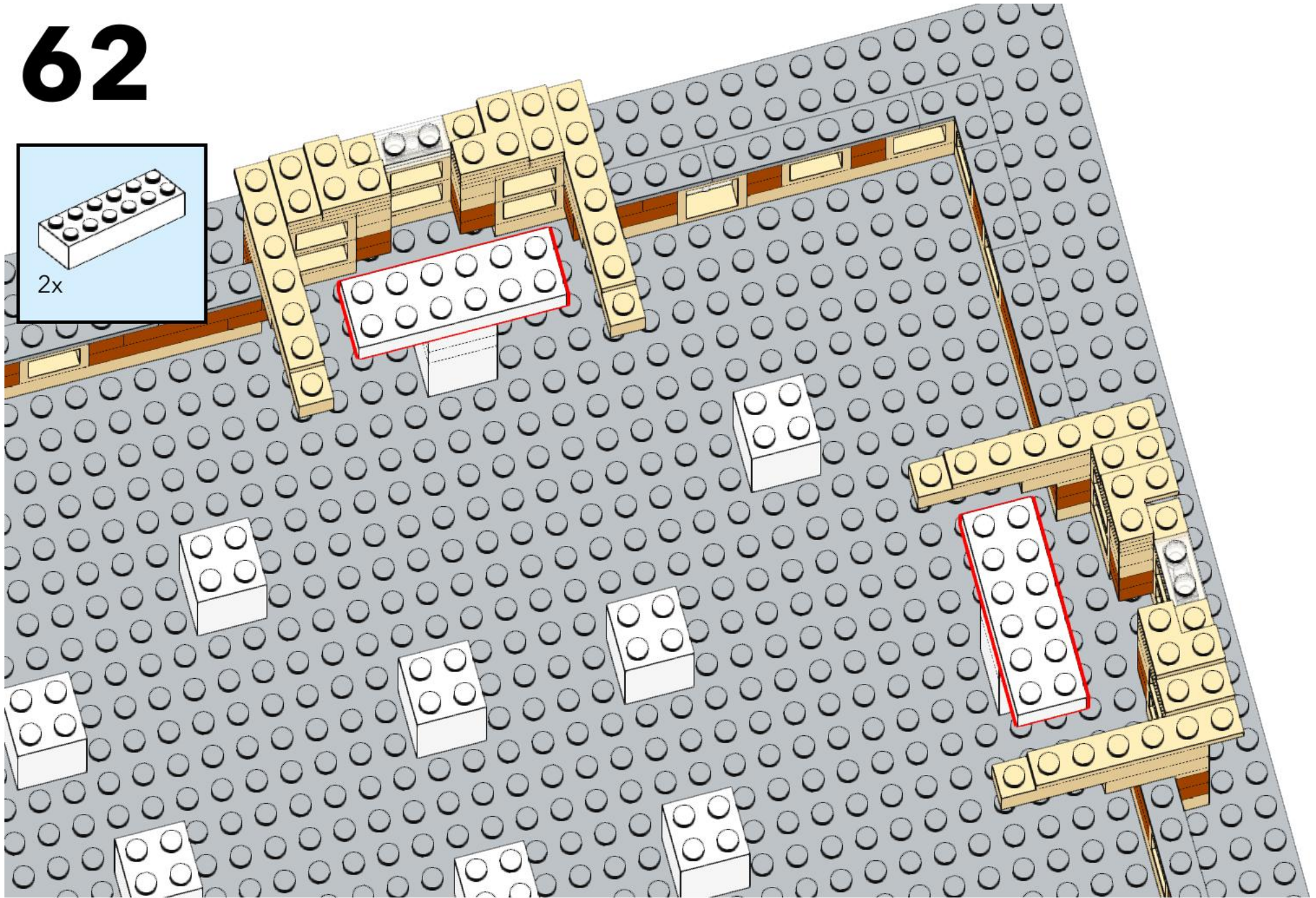
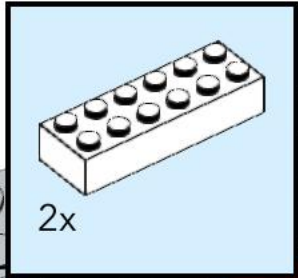

# 63

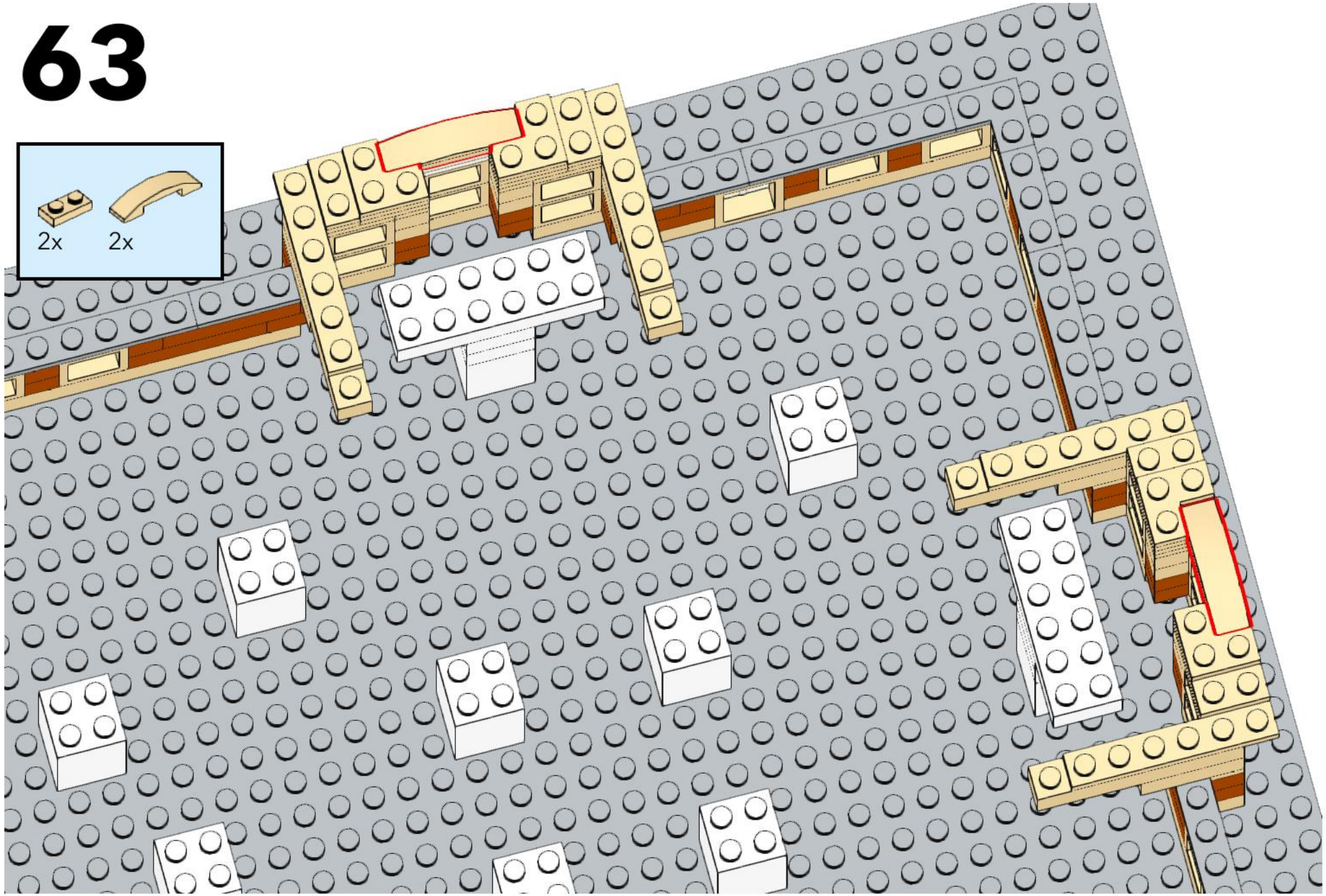
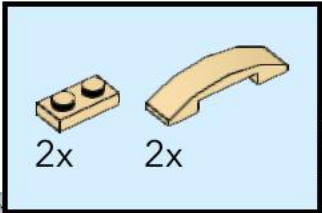



# 64

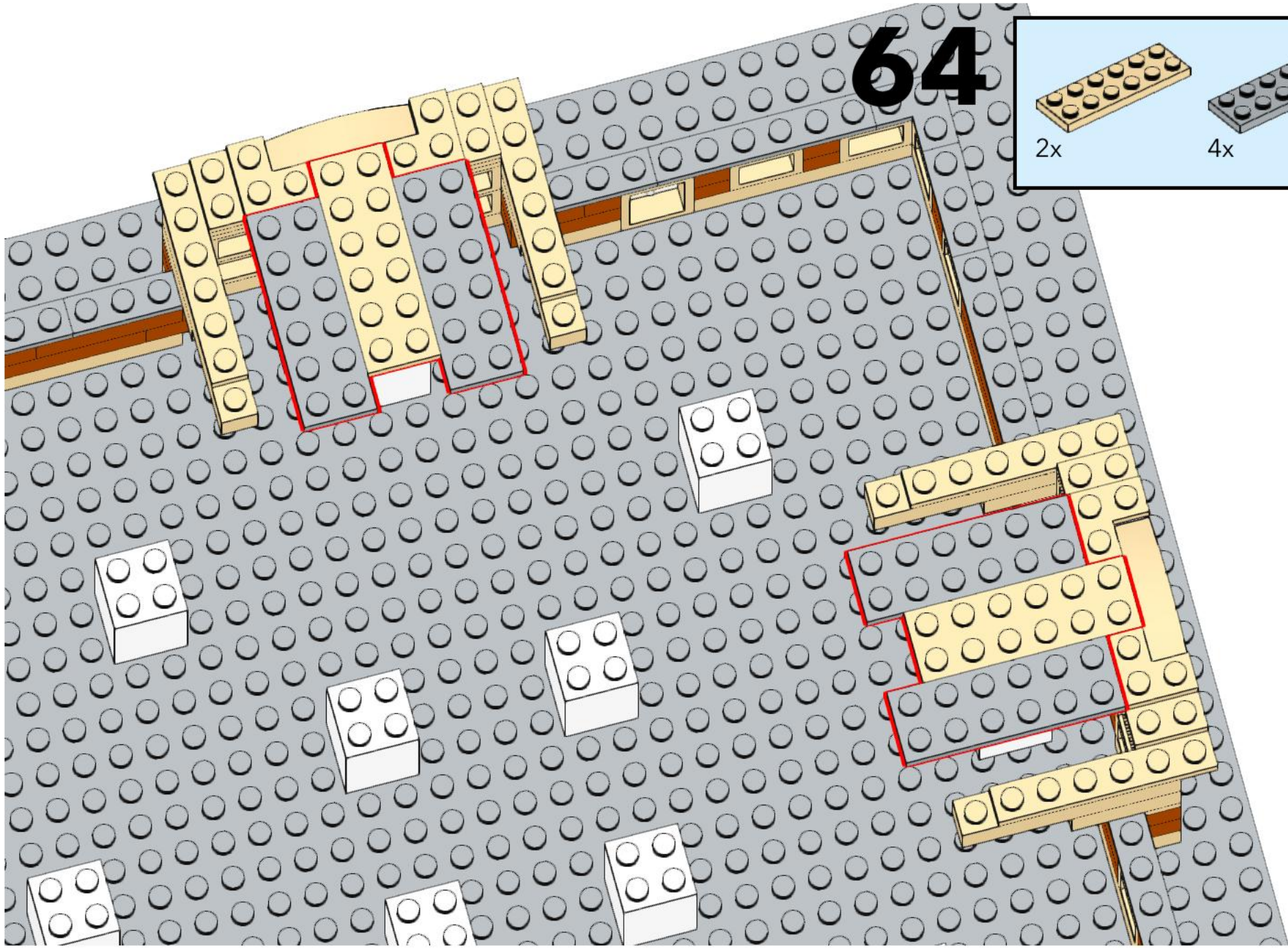
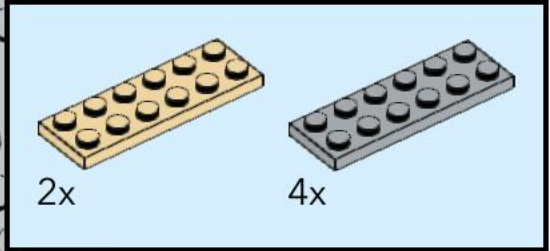

65

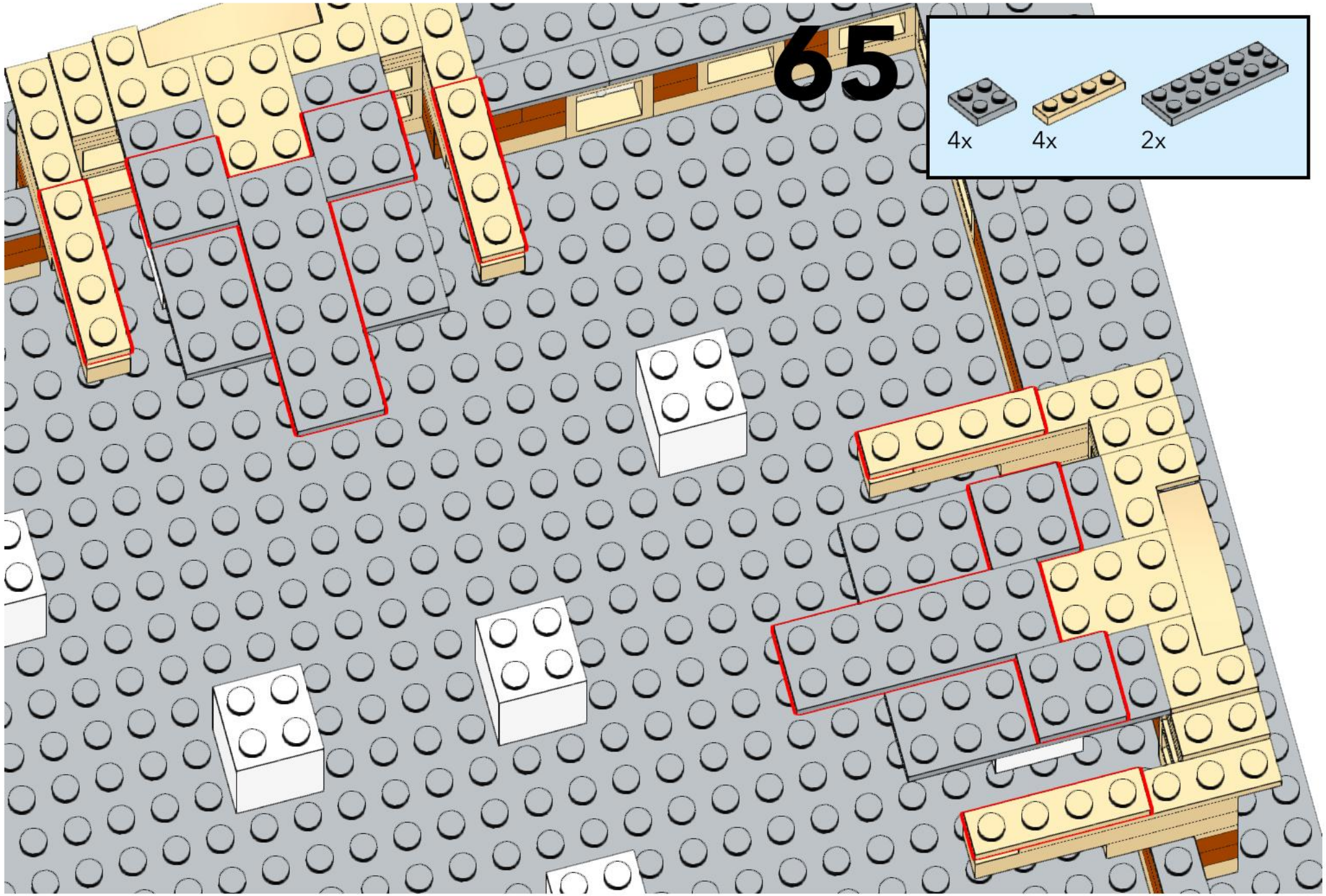
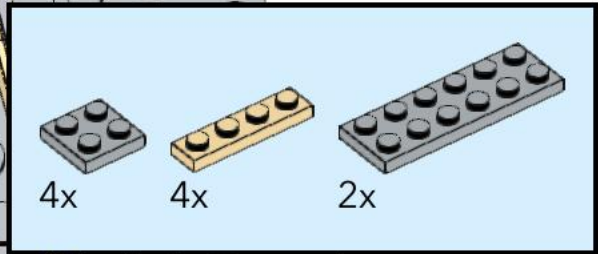

66

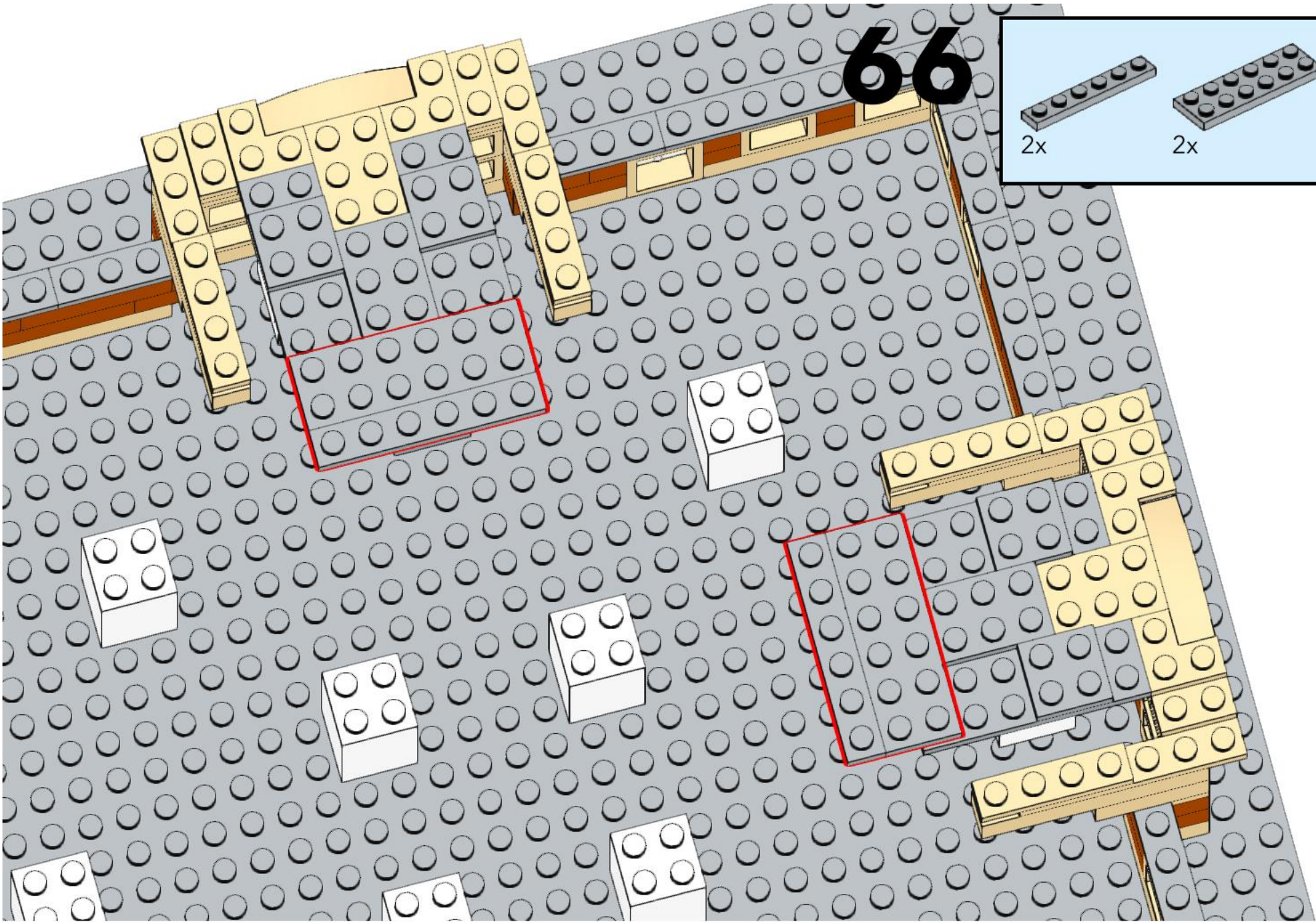
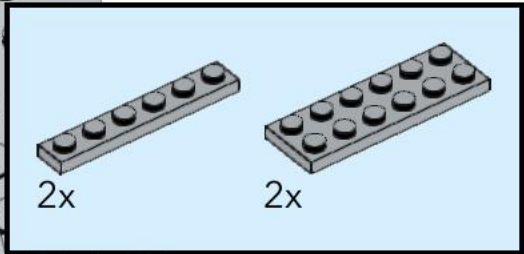

# 67

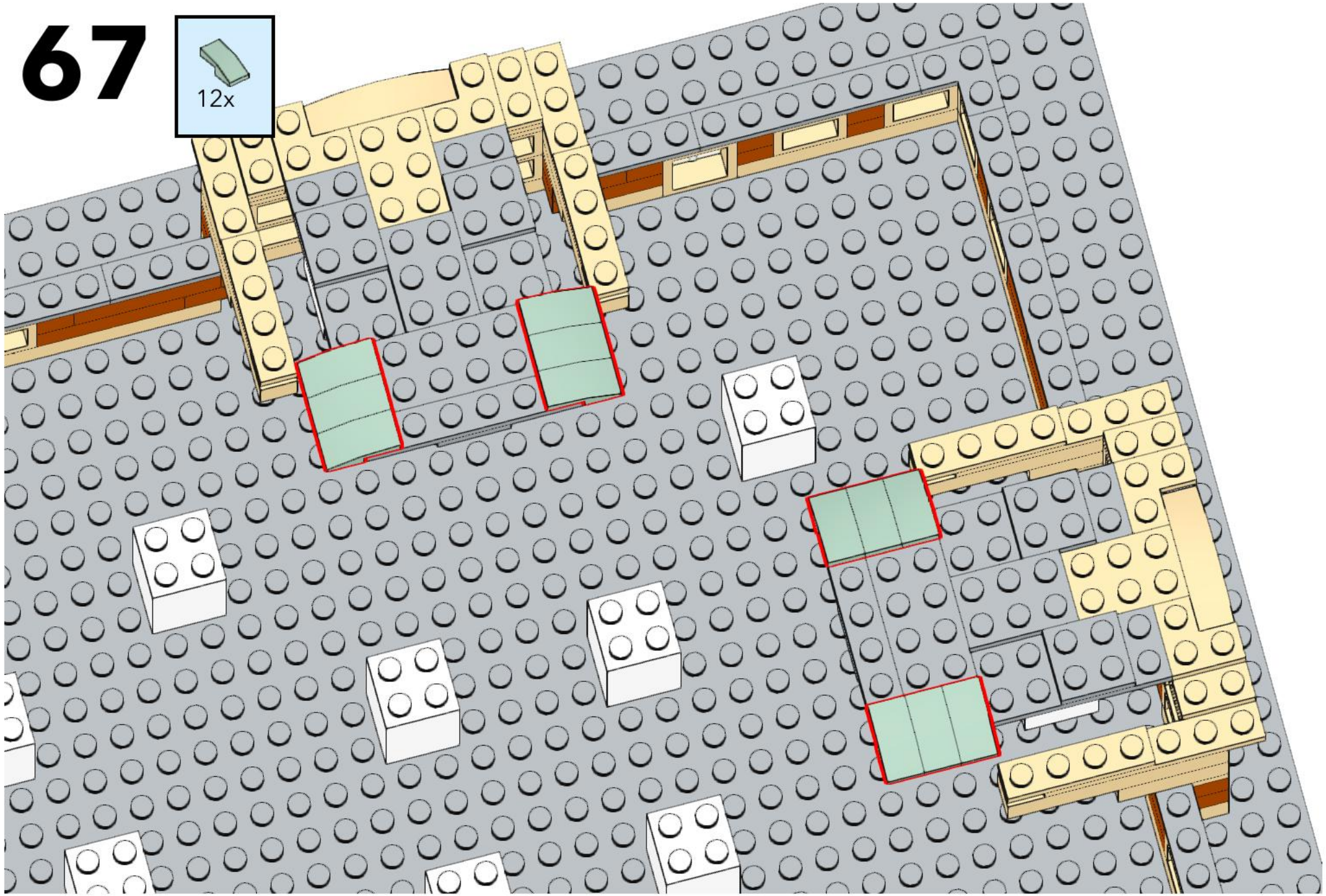
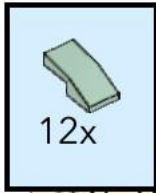

68

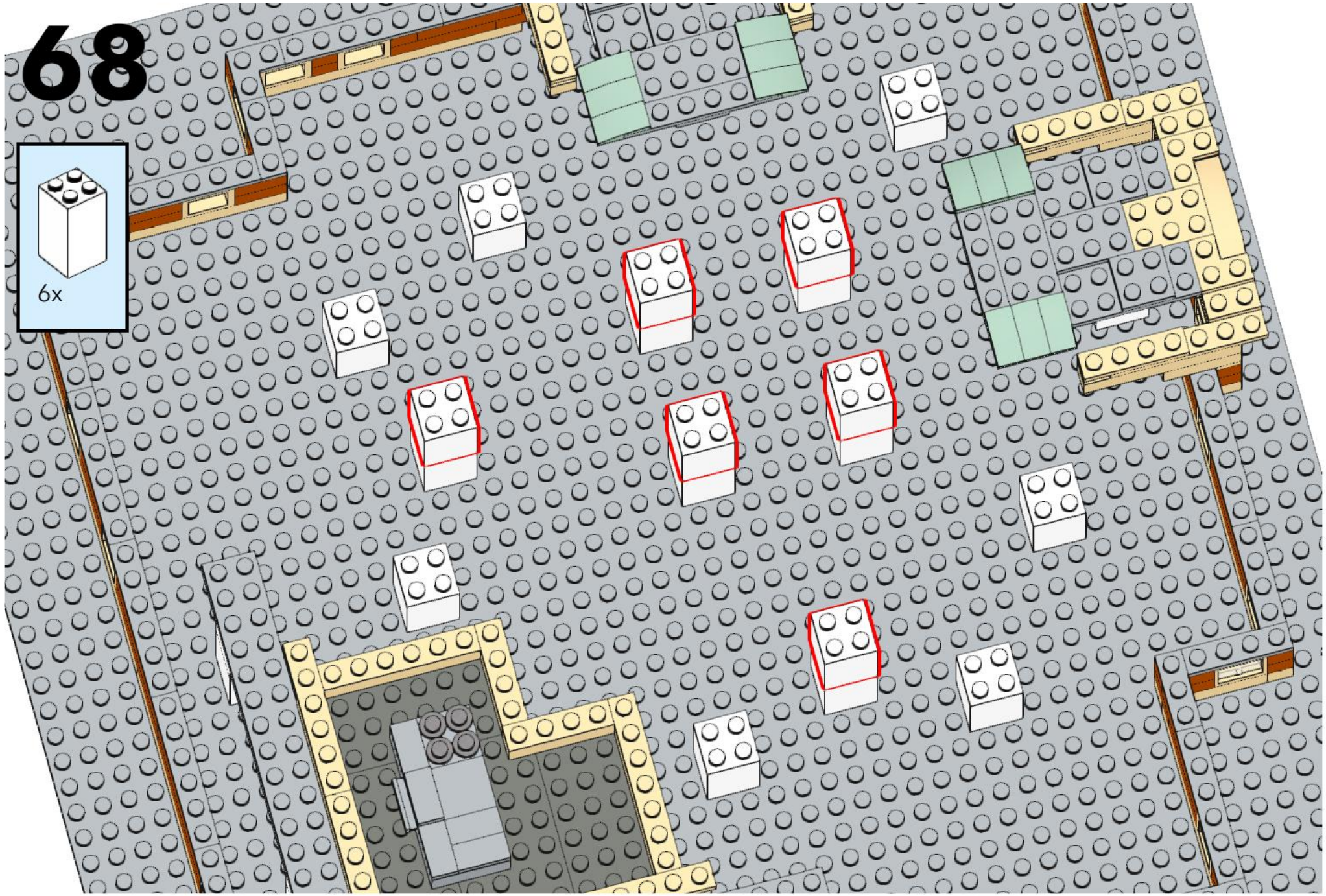
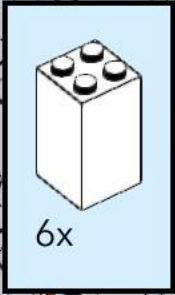

# 69

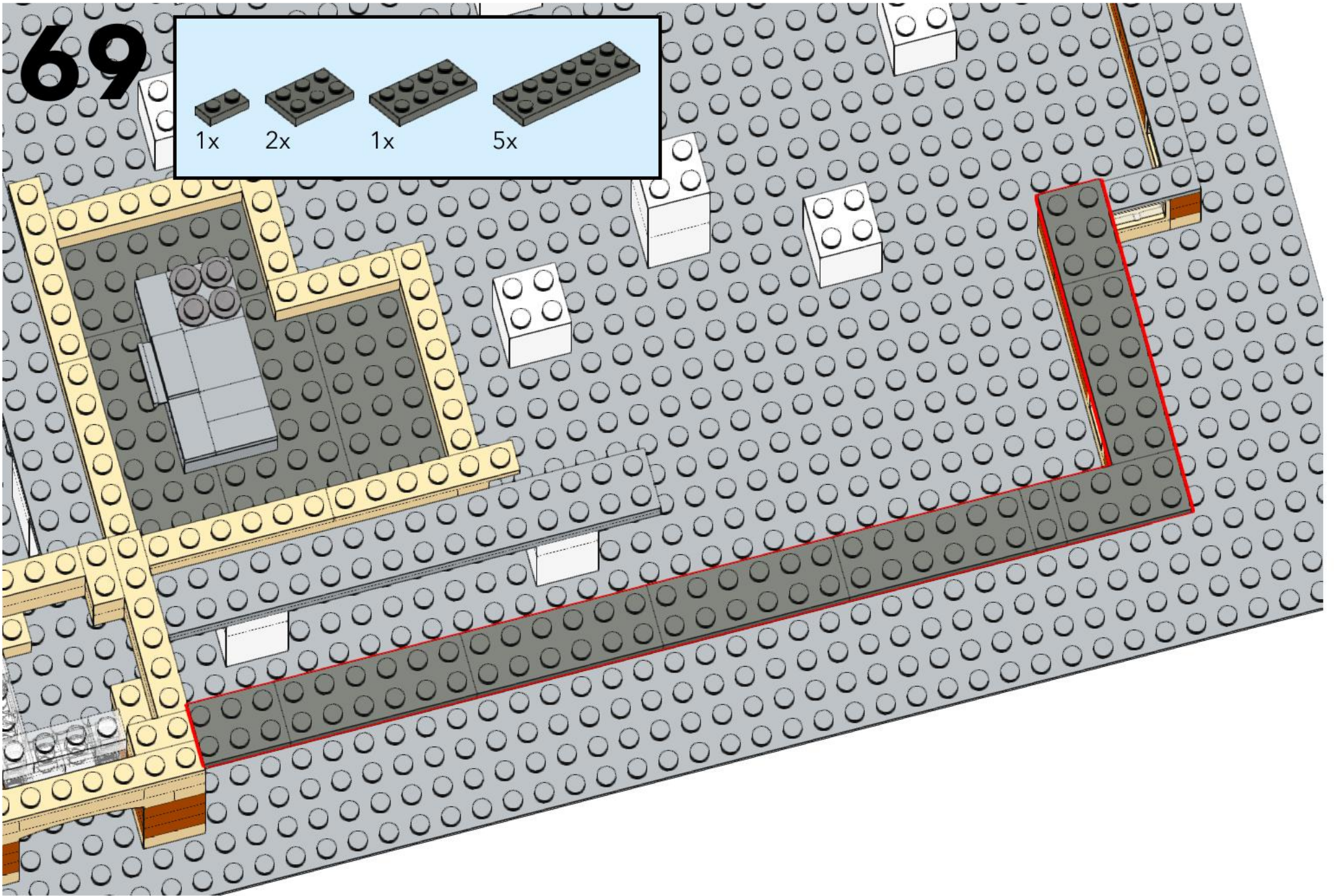
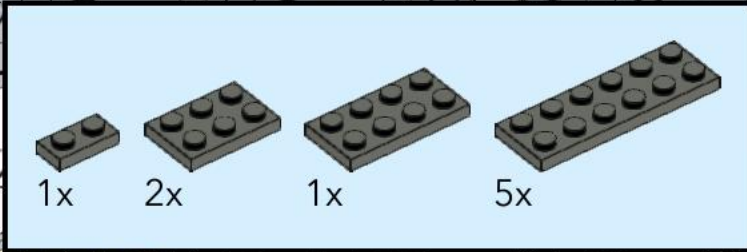

# 70

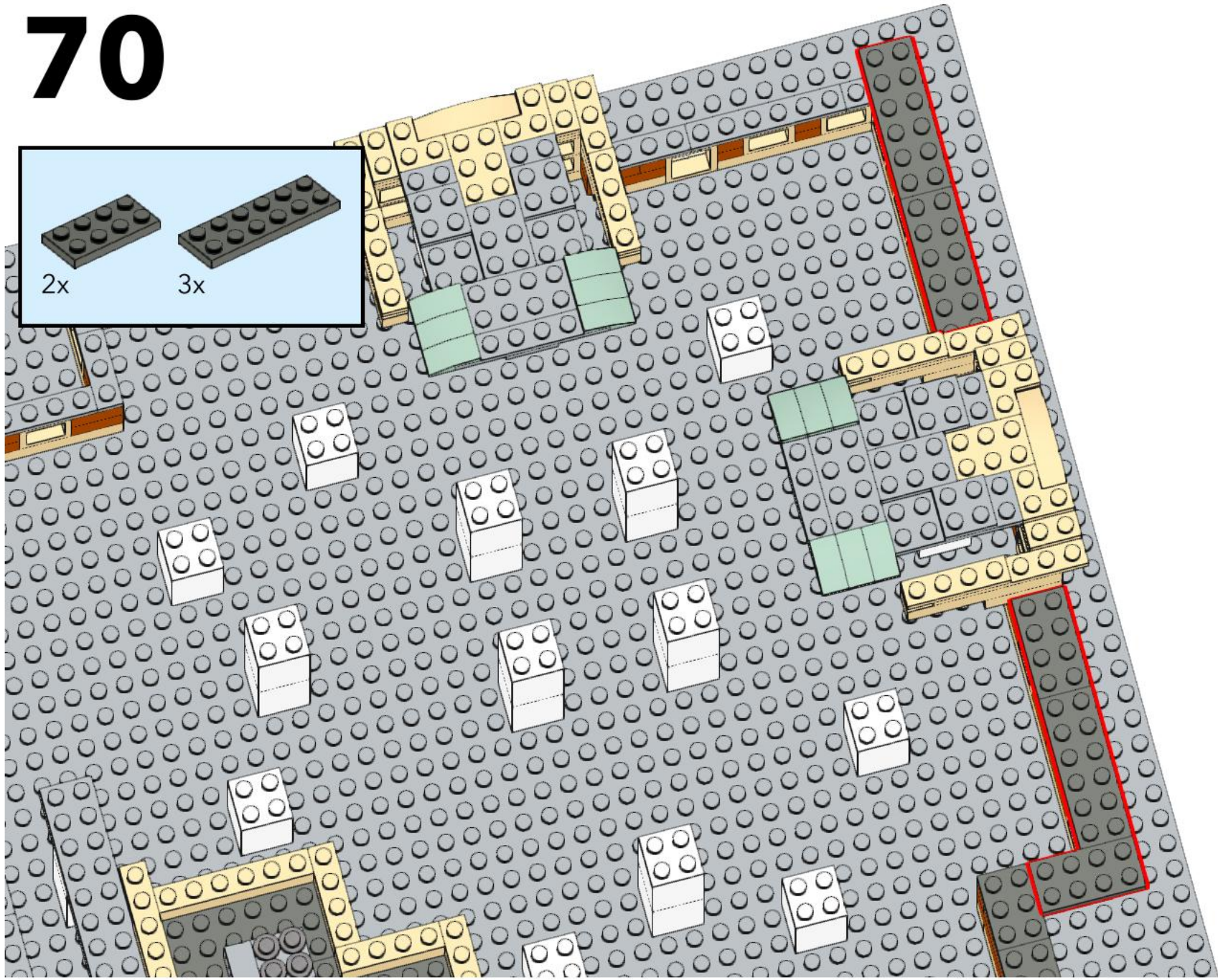
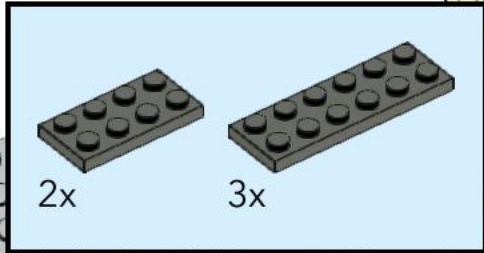

# 71

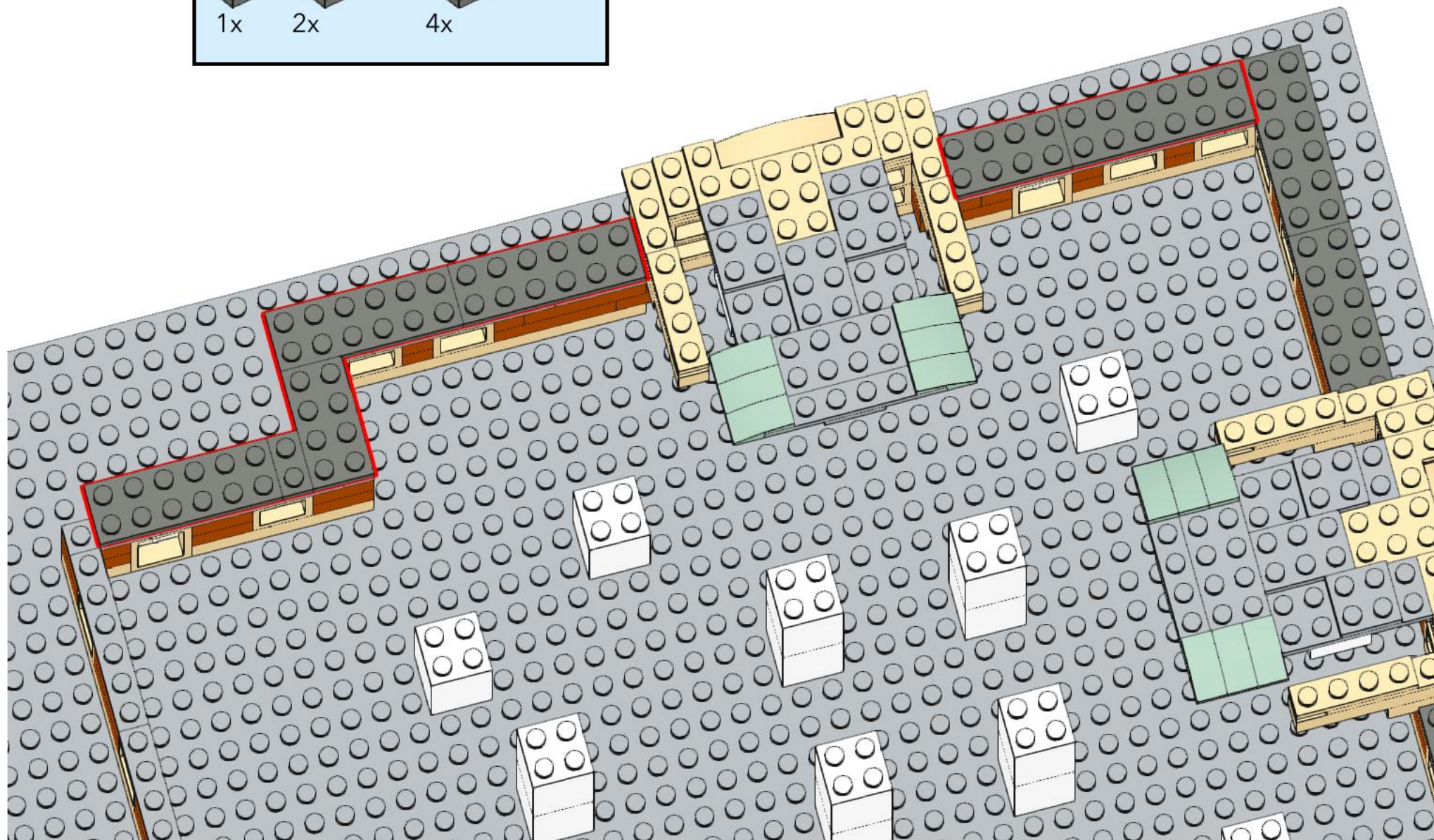
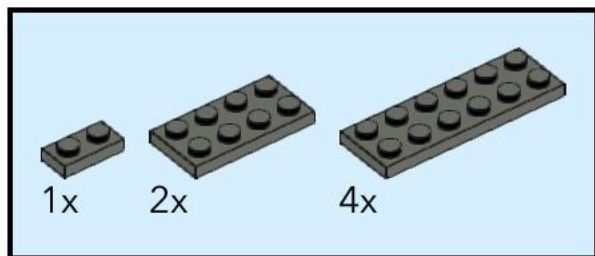



# 72

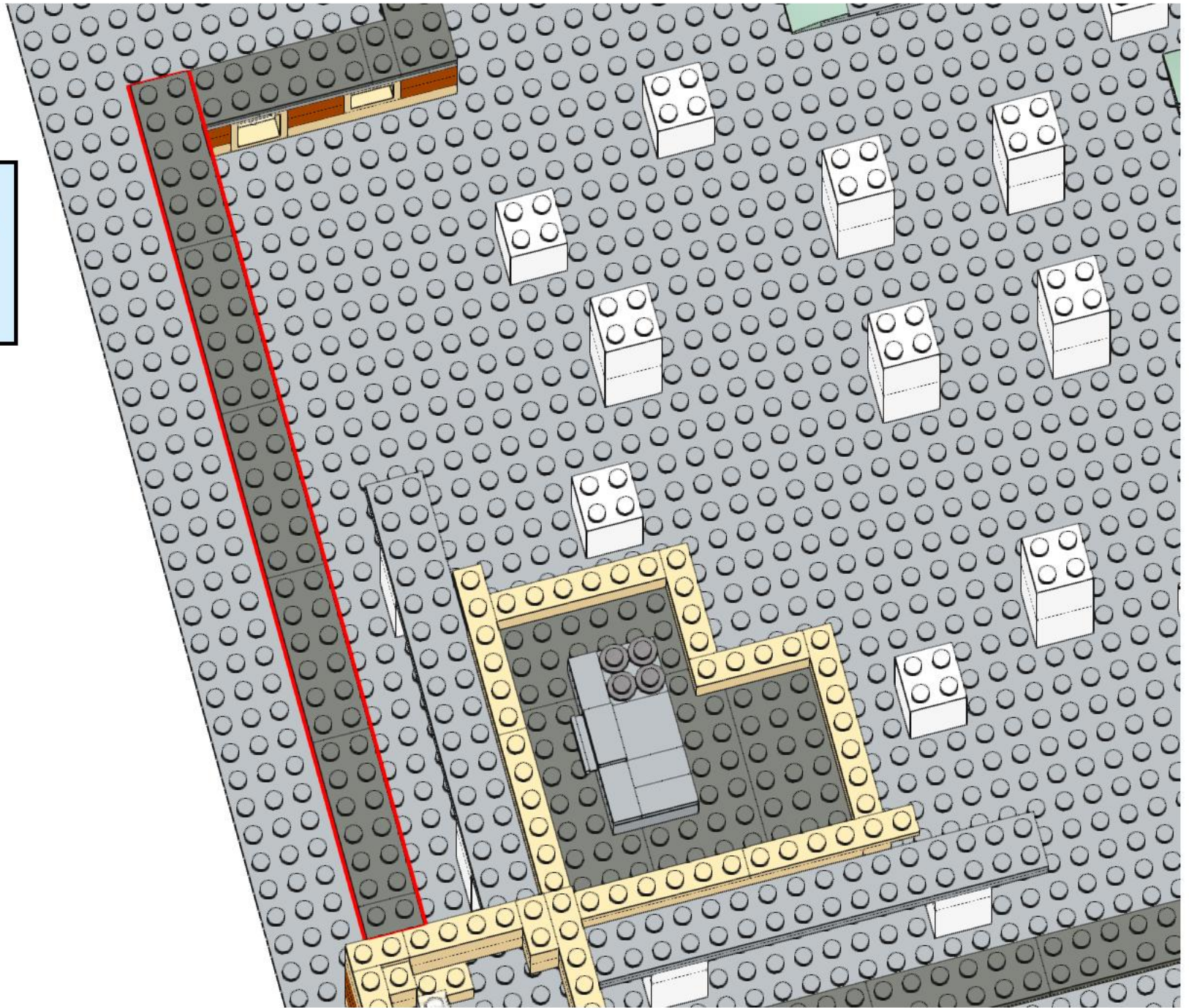
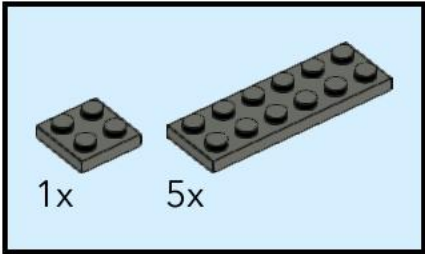

# 73

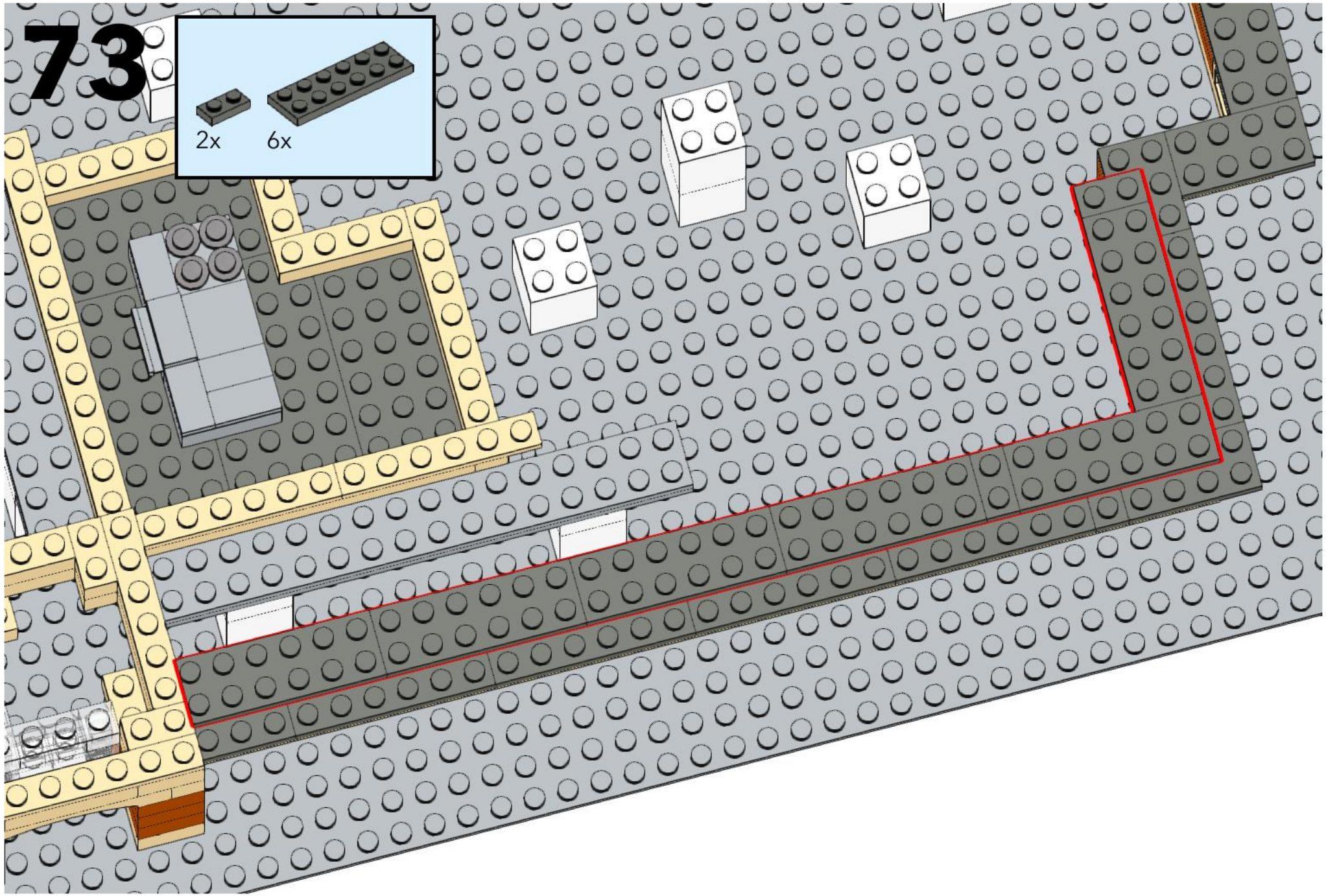
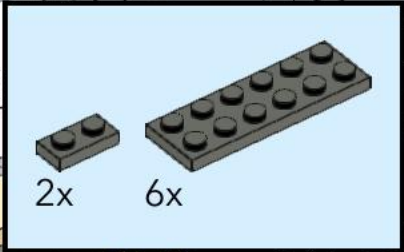

# 74

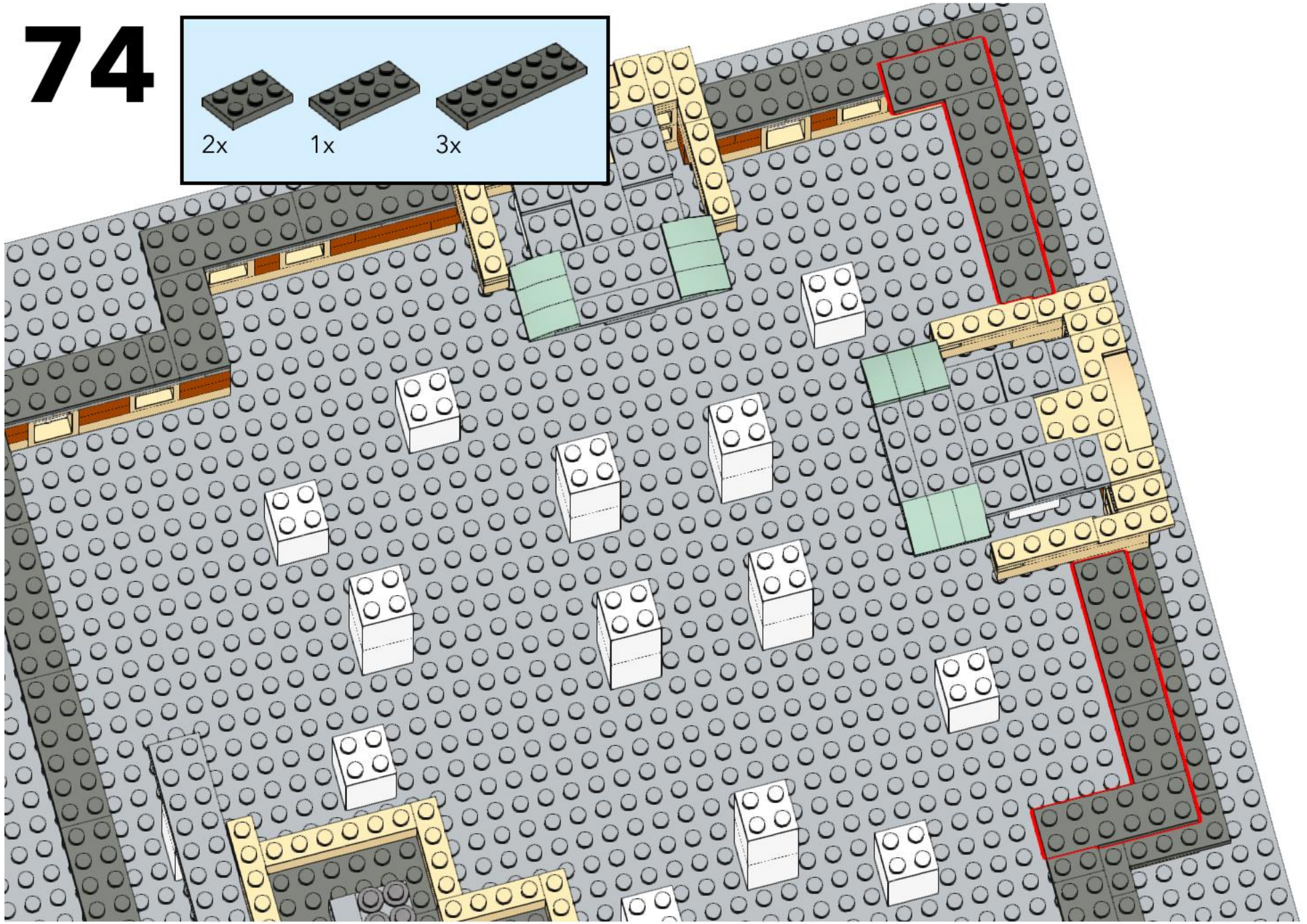
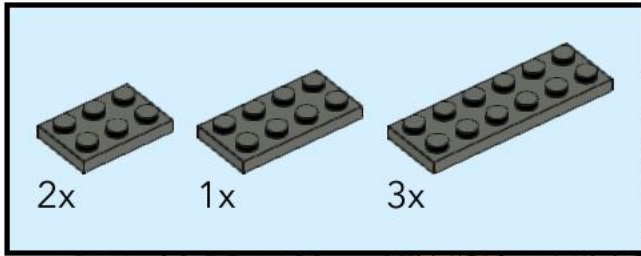

# 75

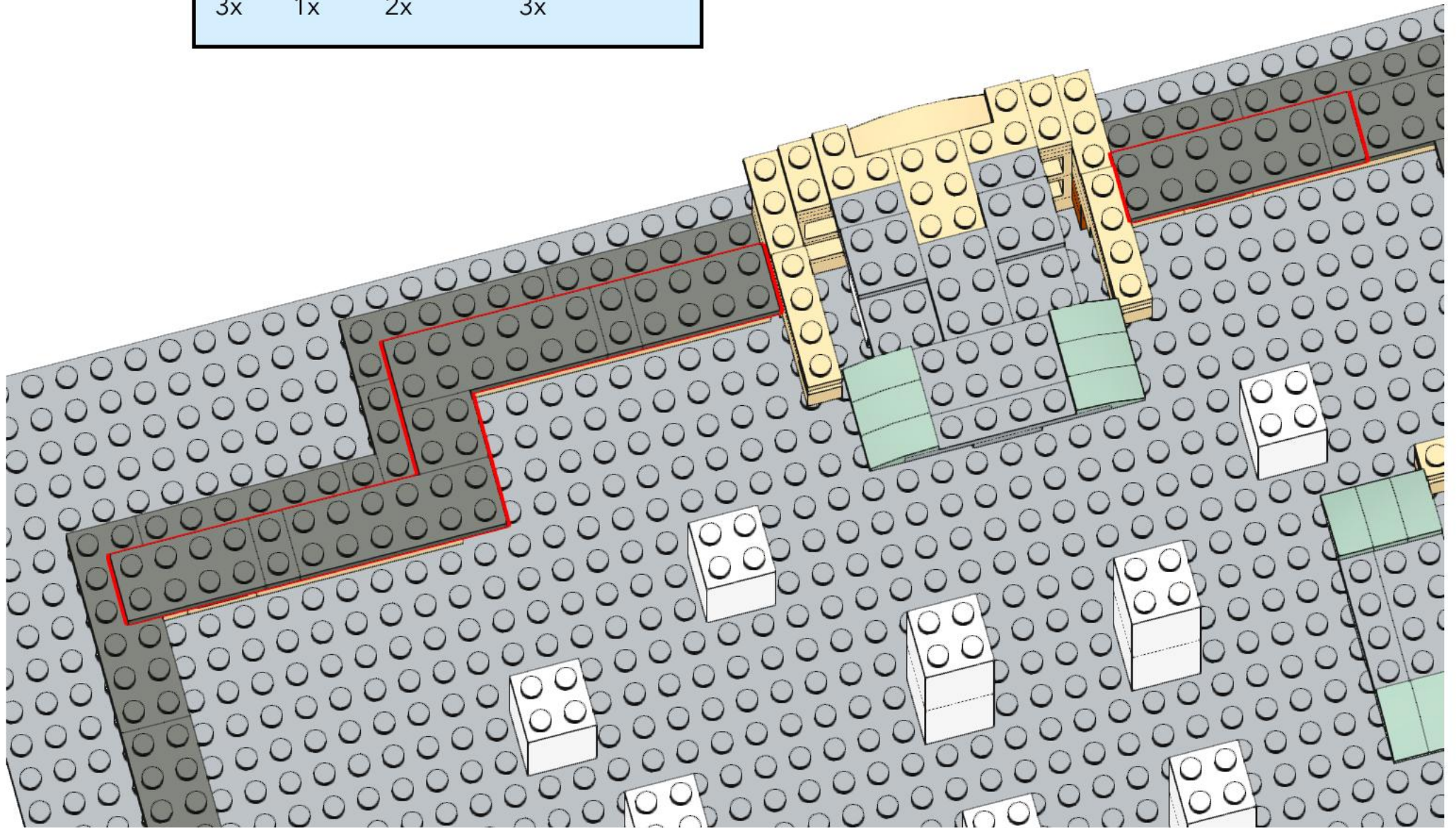
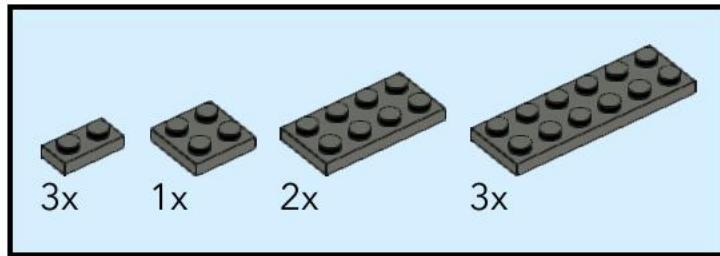

# 76

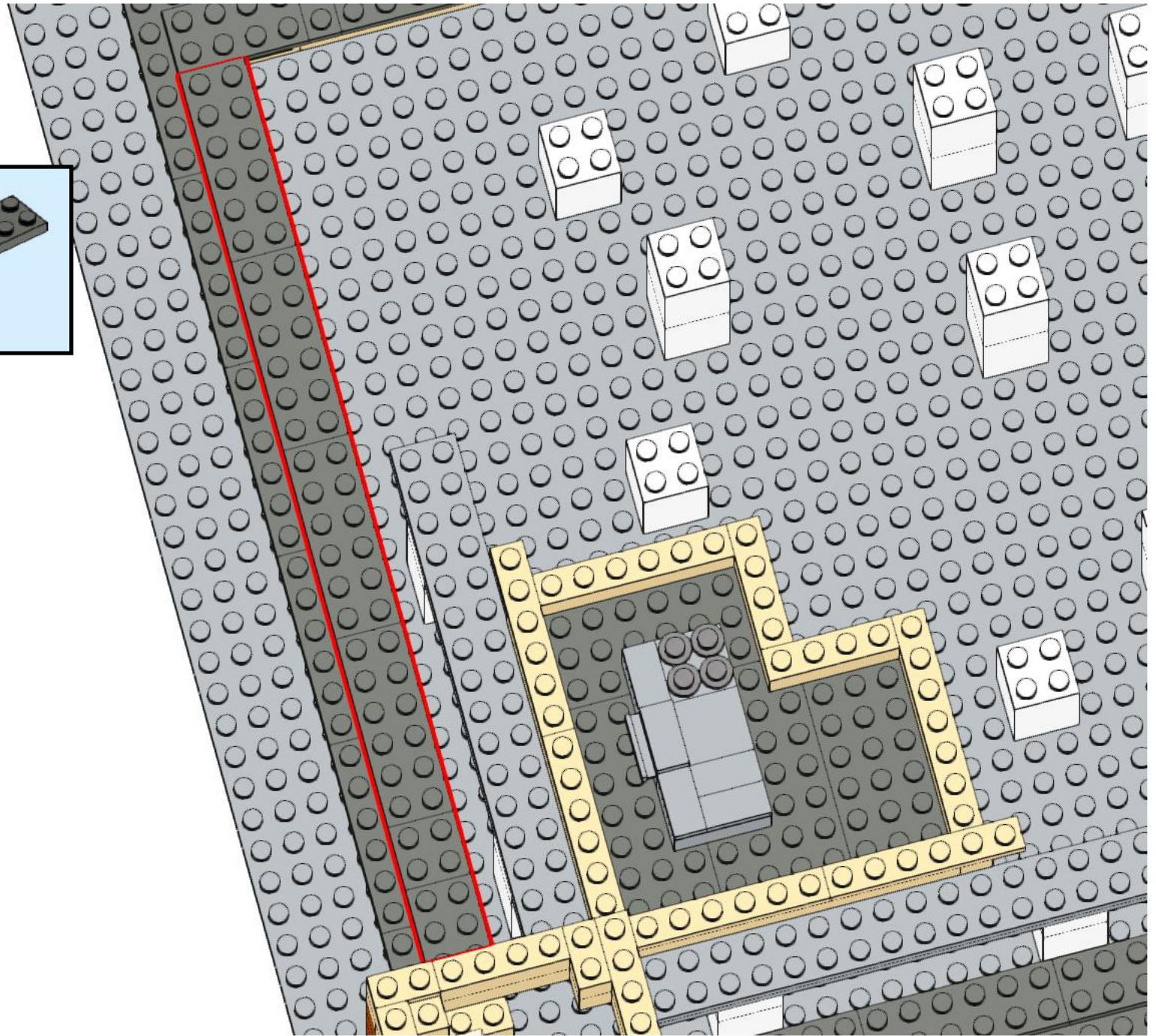
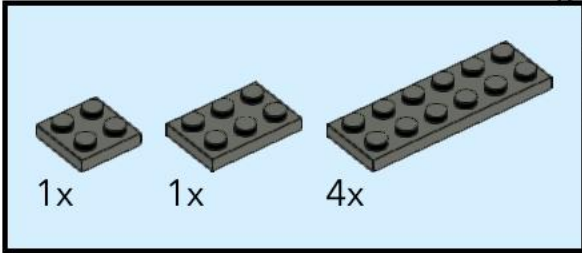

# 77

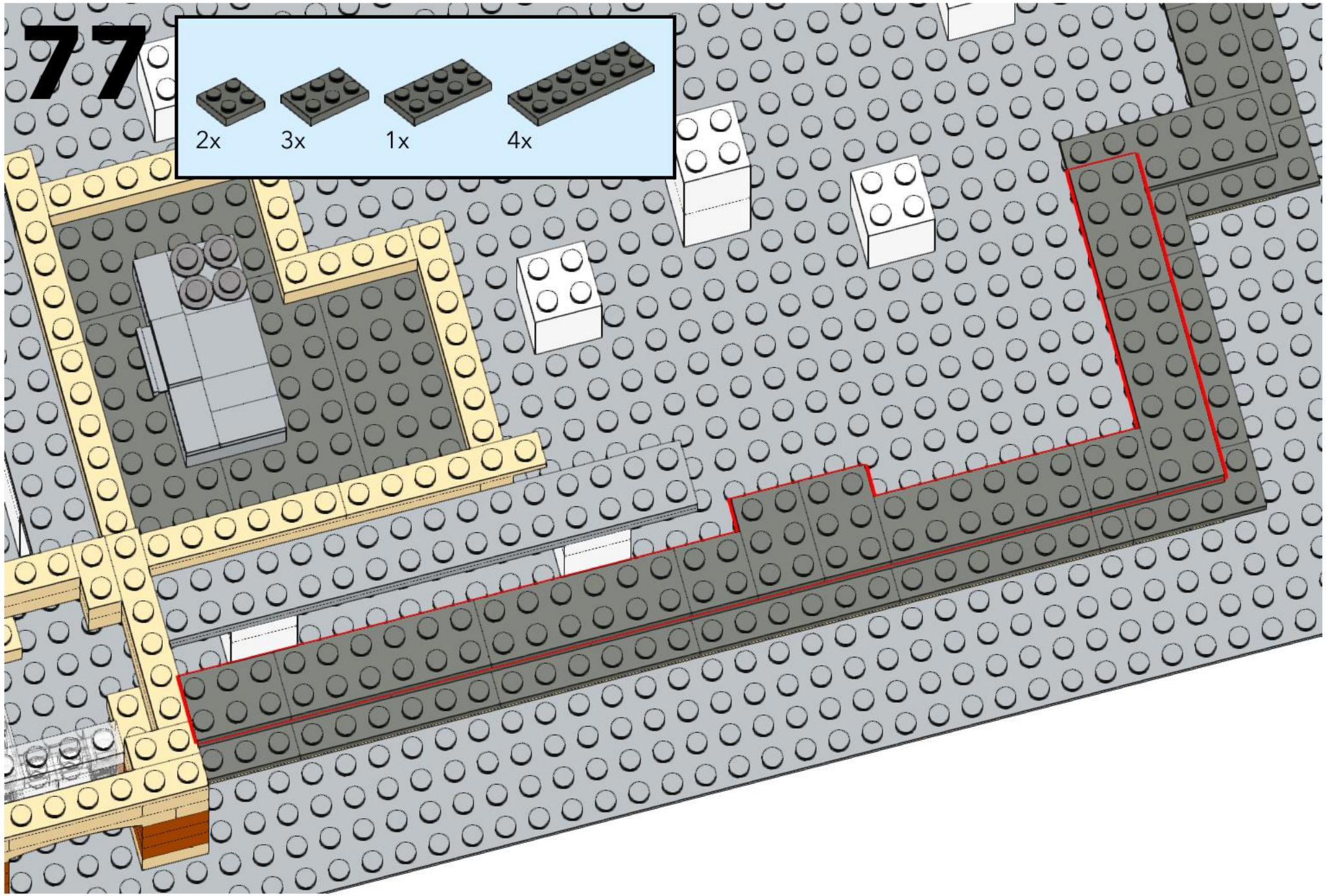
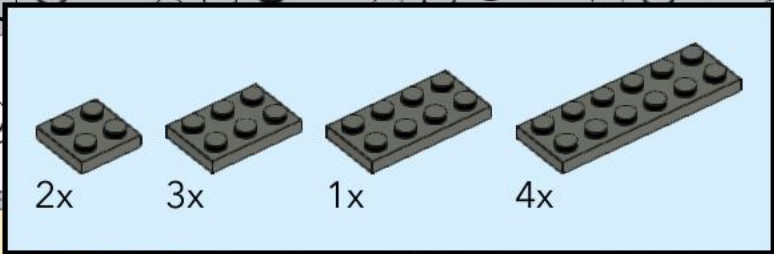

# 78

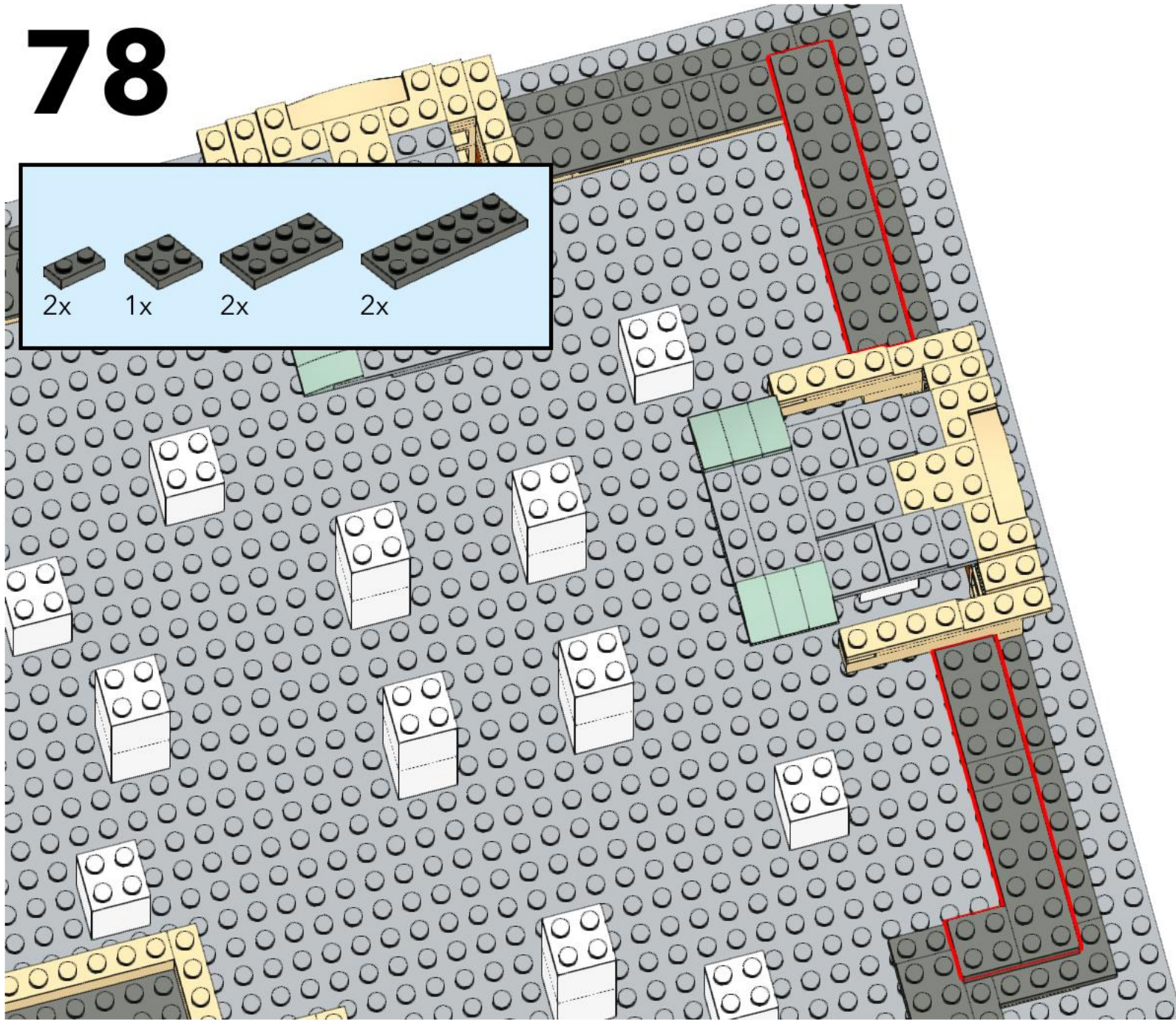
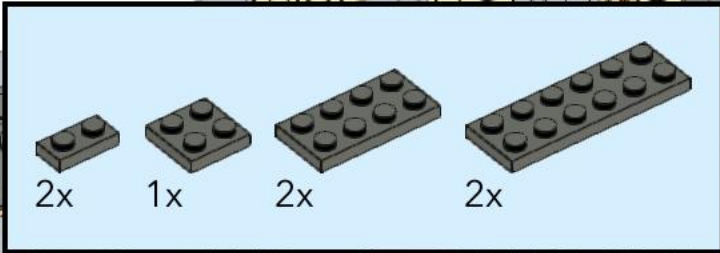

# 79

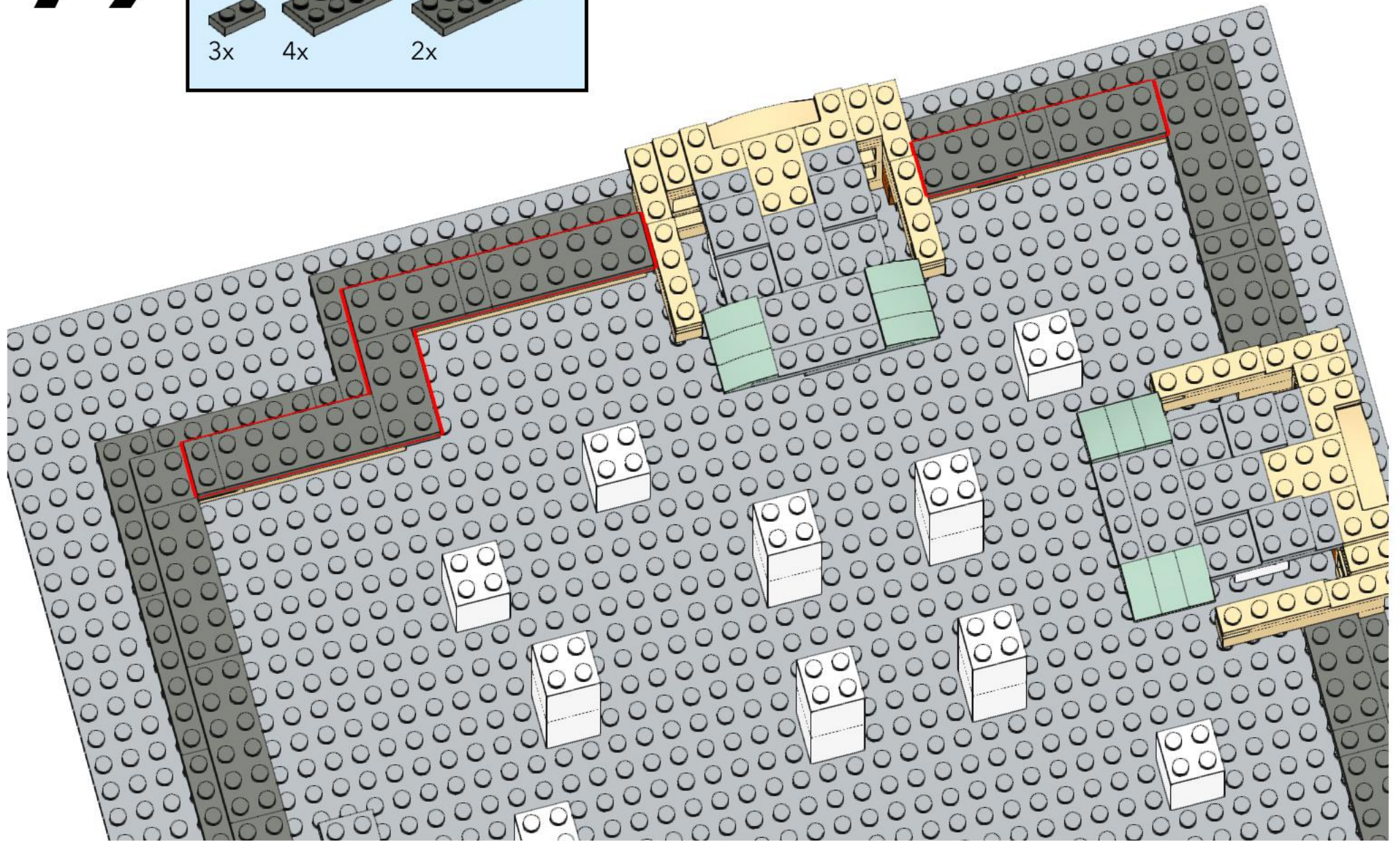
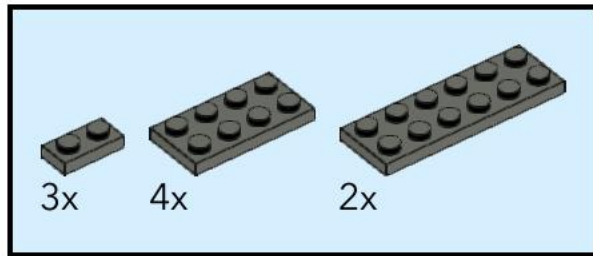



# 80

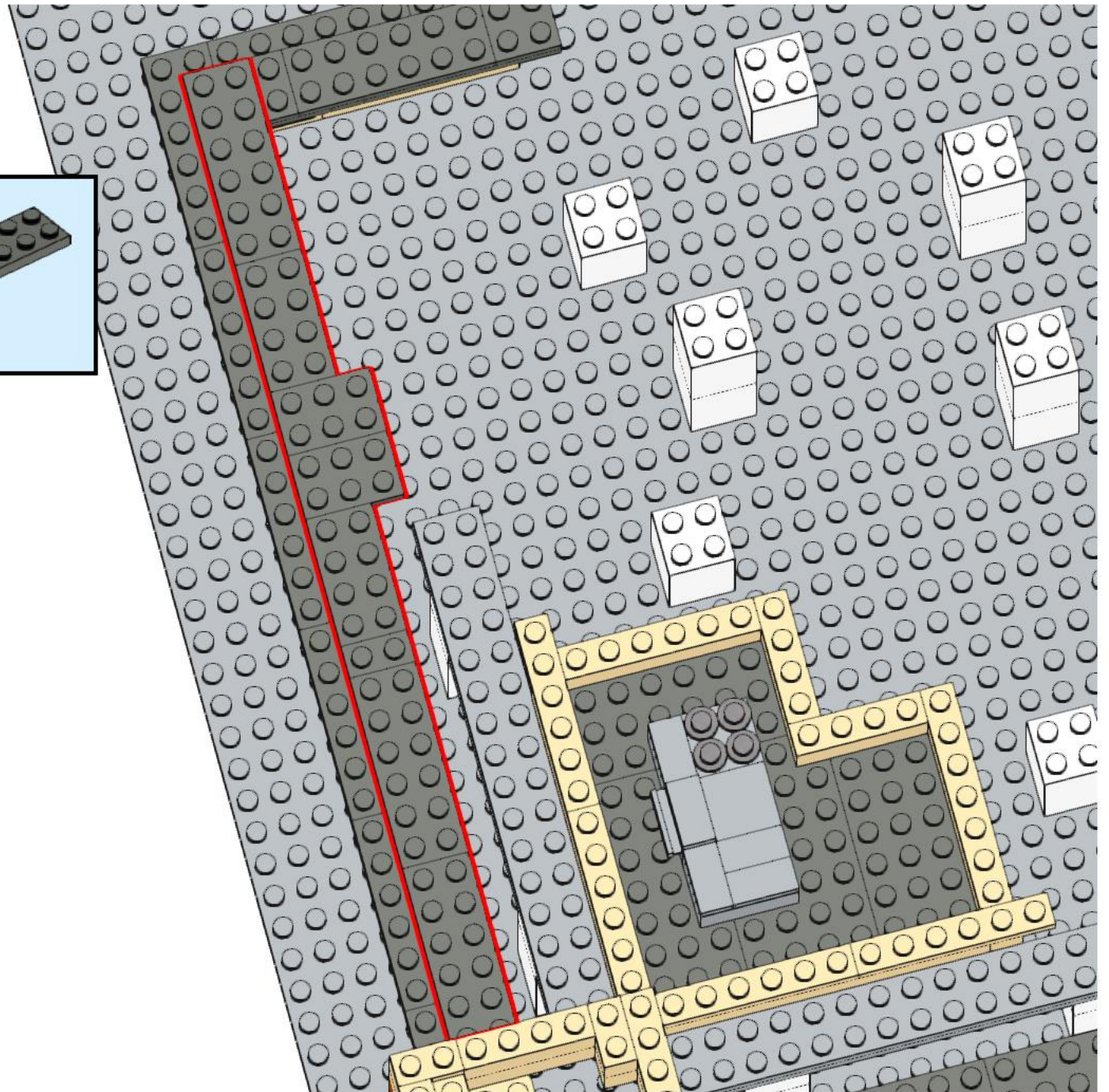
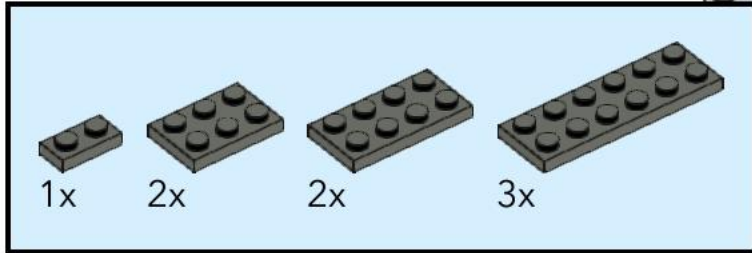

# 81

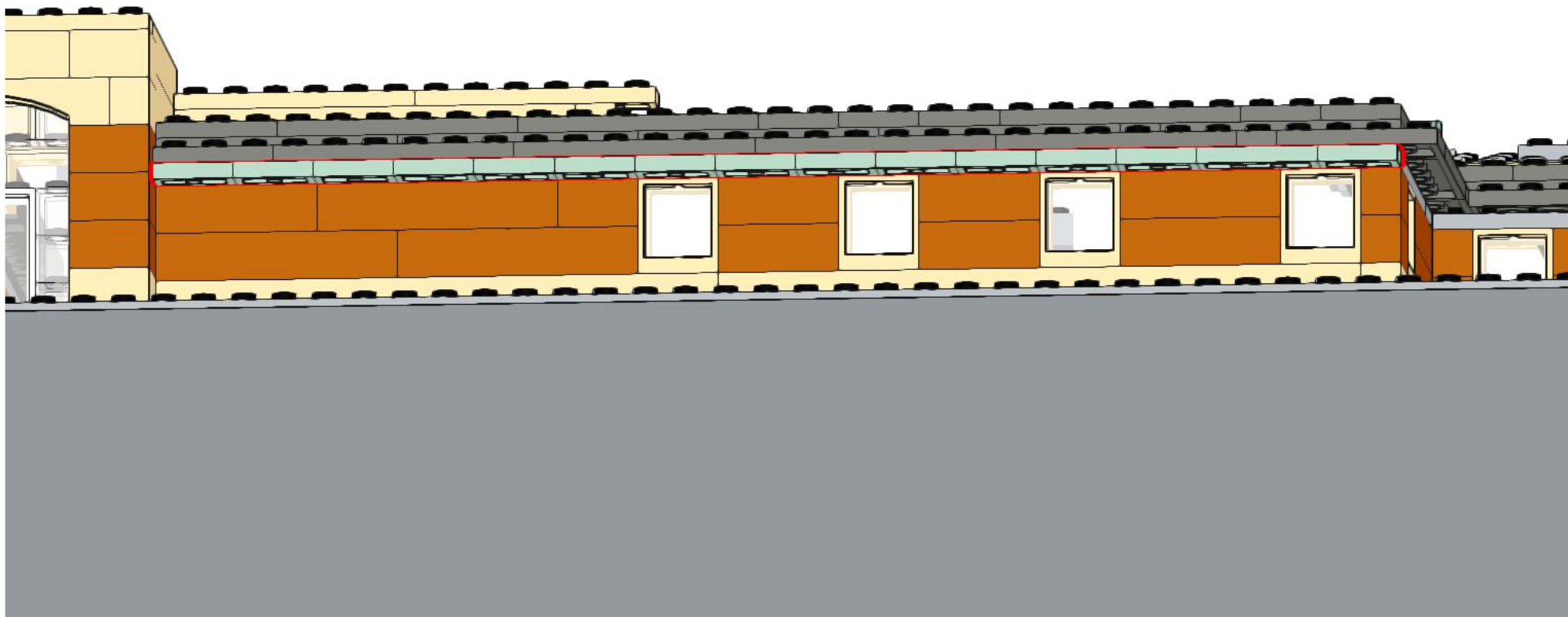
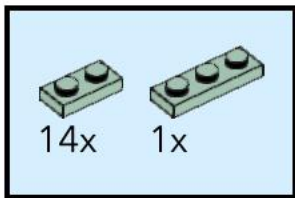

# 82

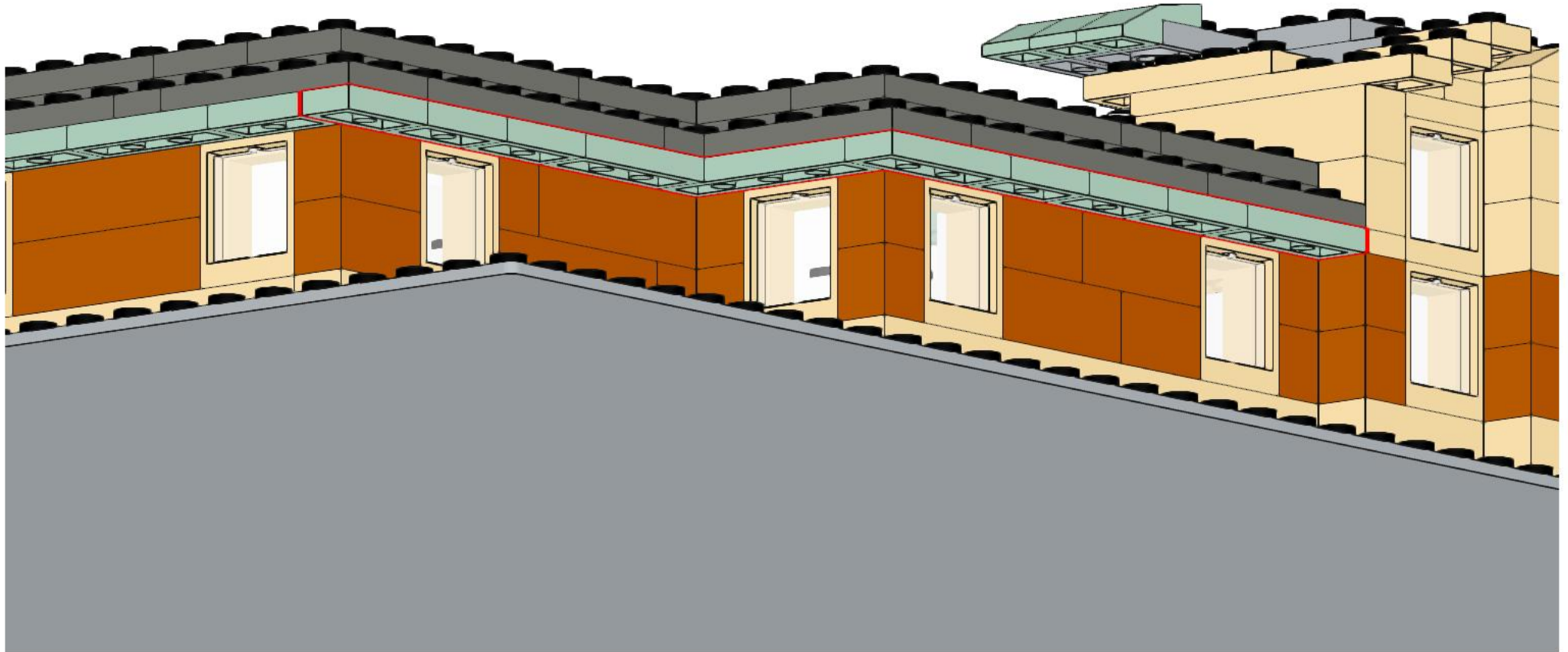
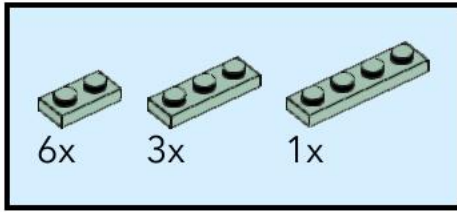

# 83

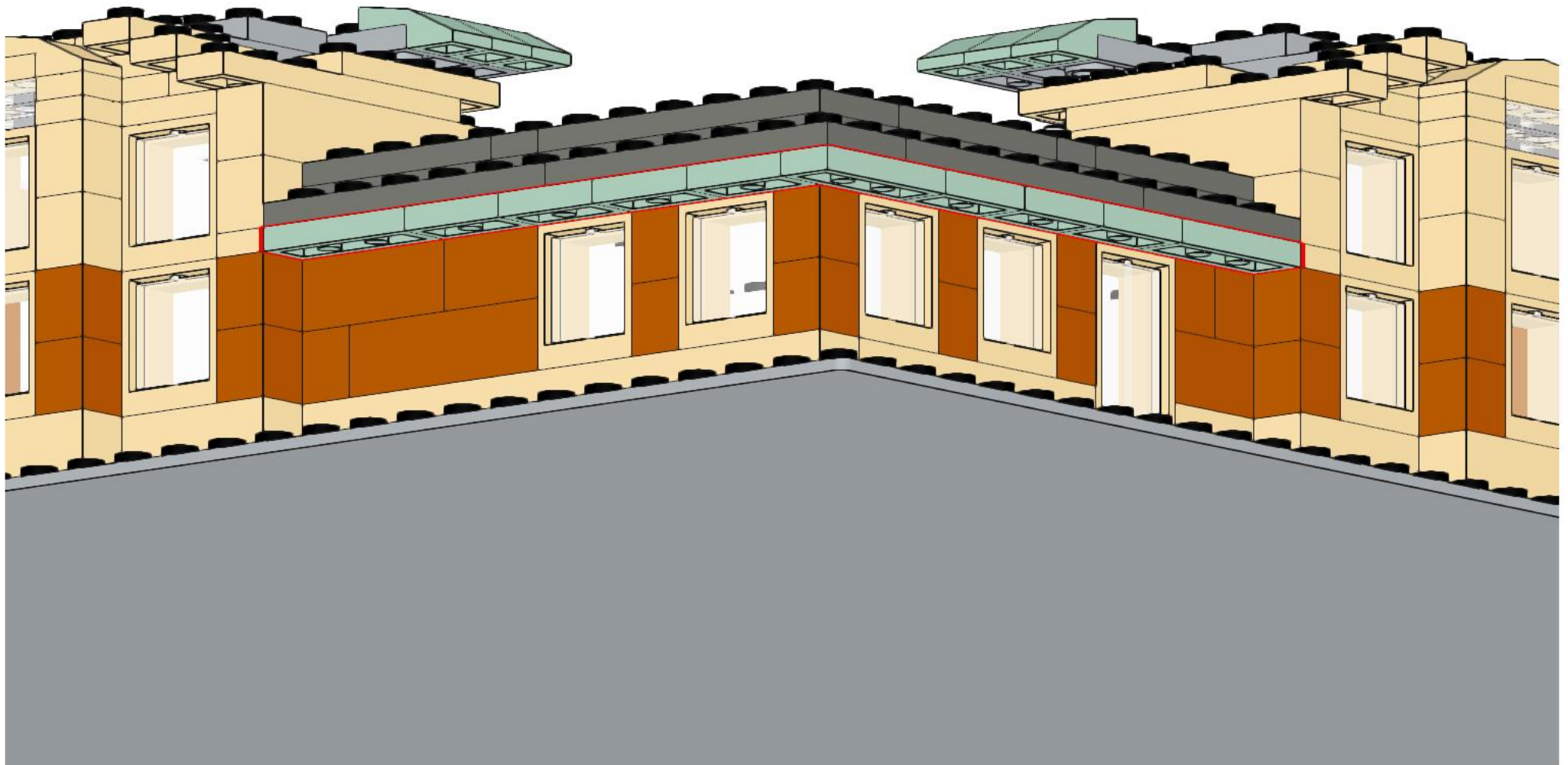
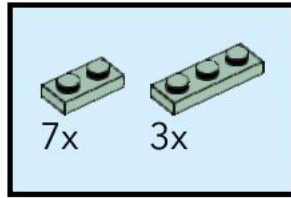

# 84

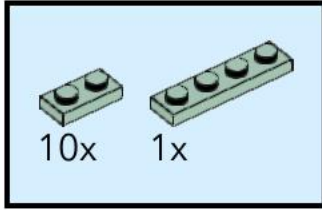

# 85

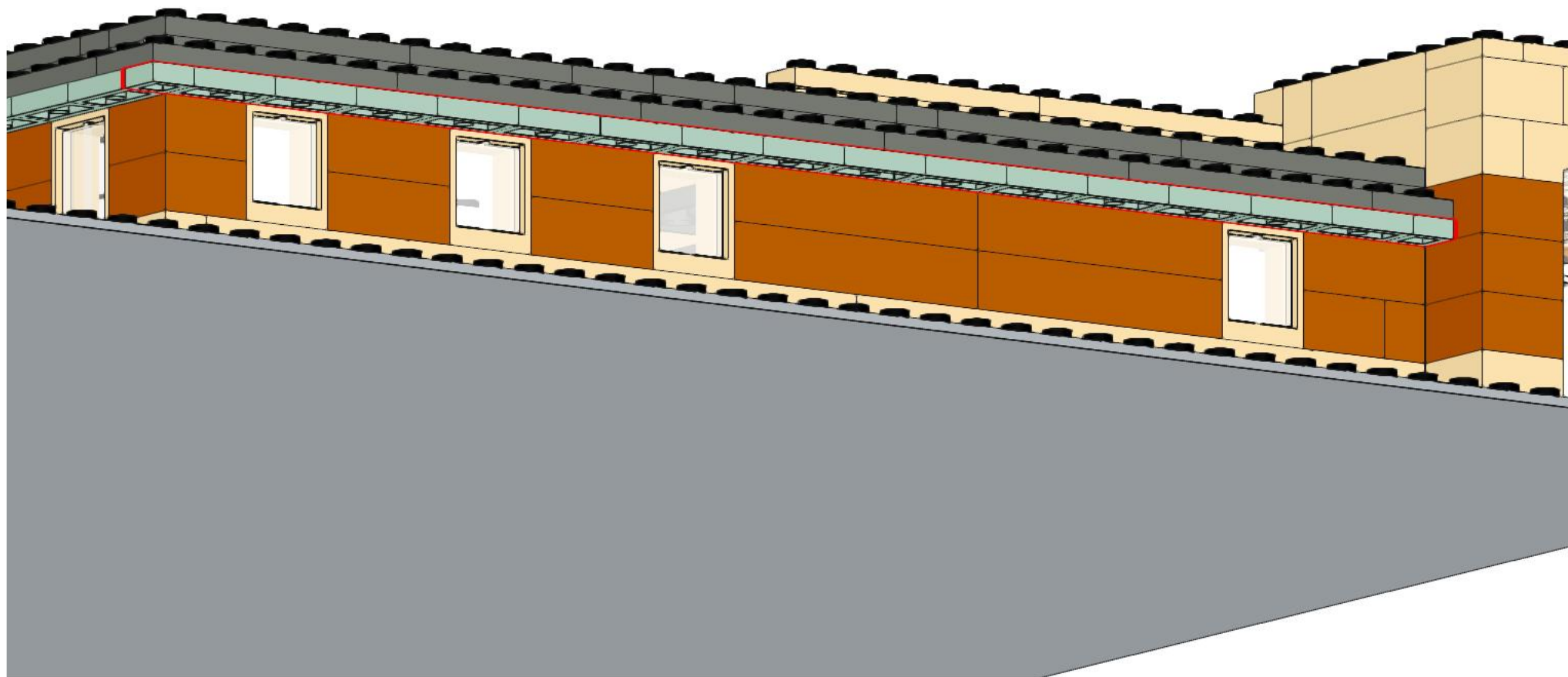
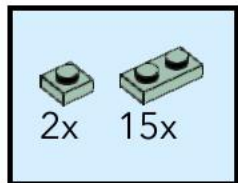

86

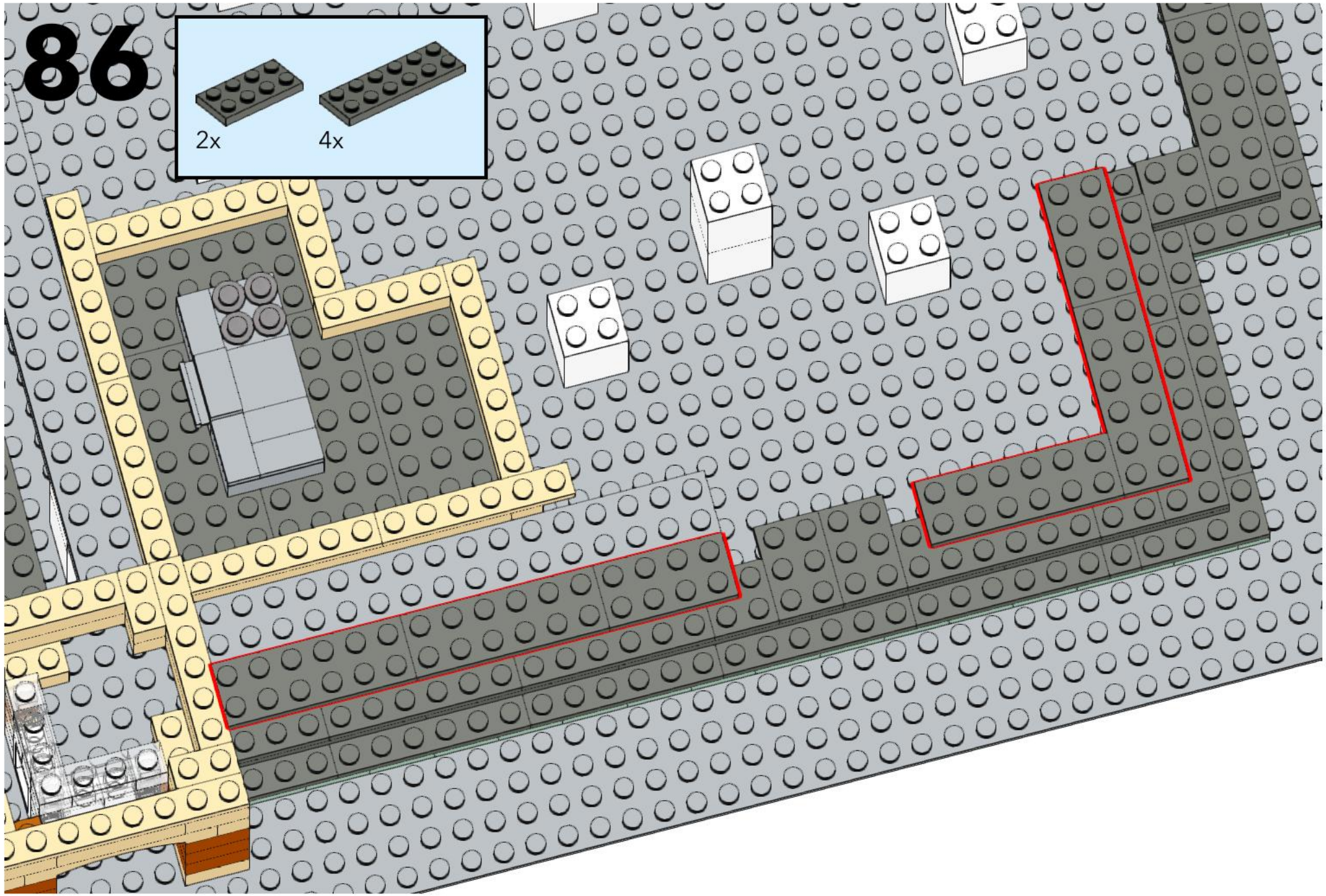
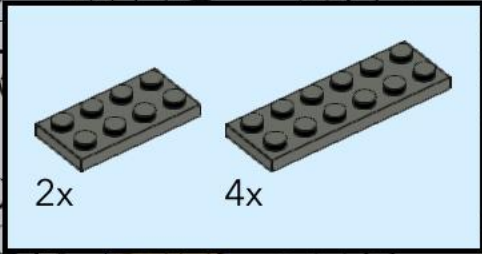

# 87

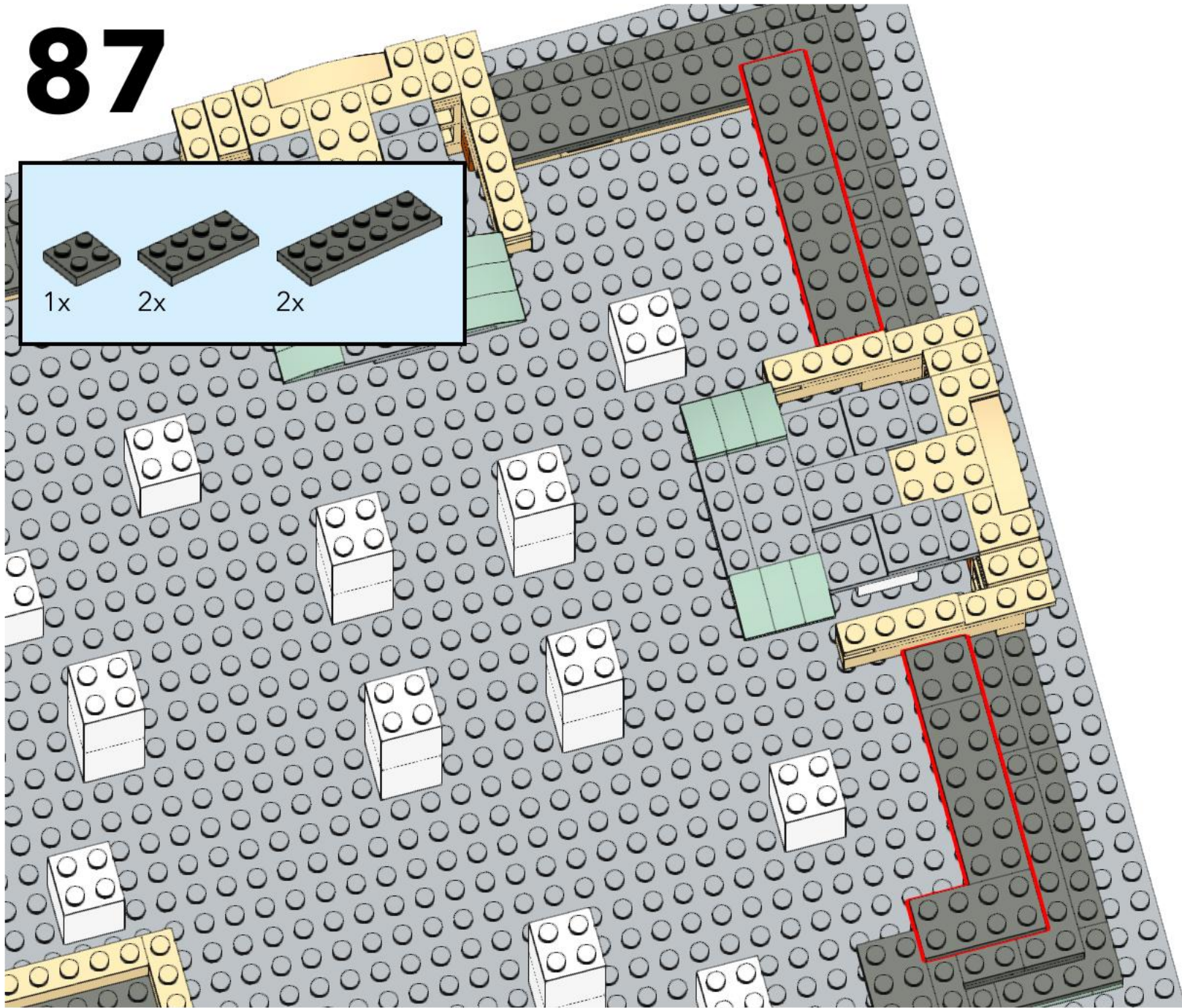
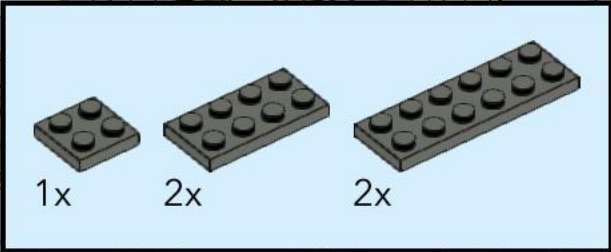



# 88

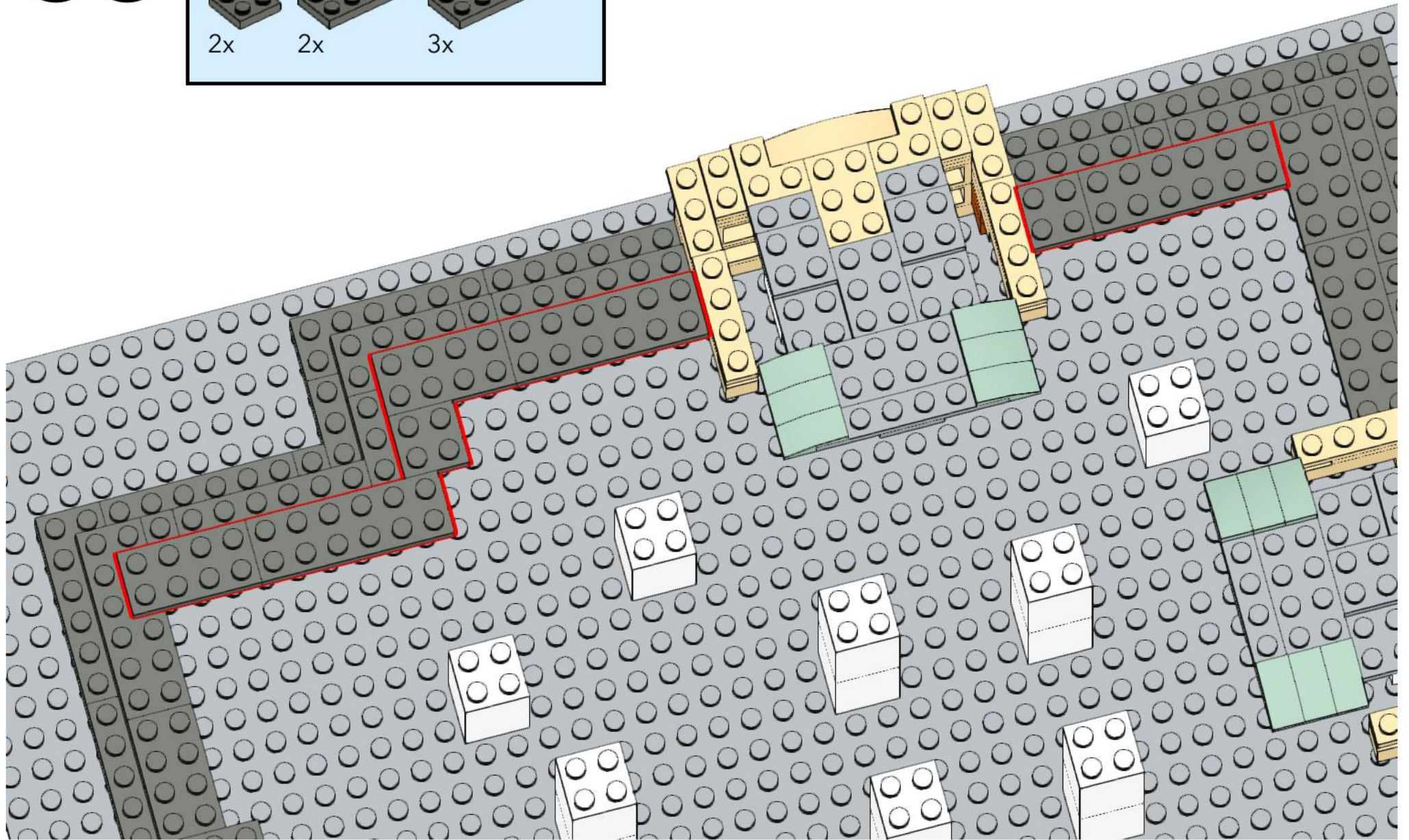
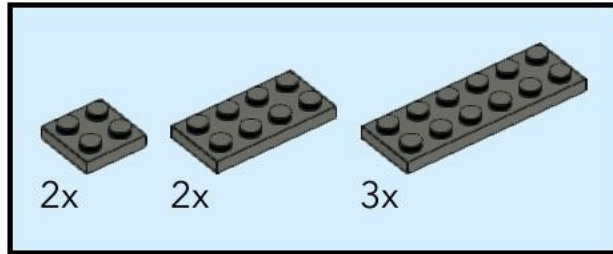



90

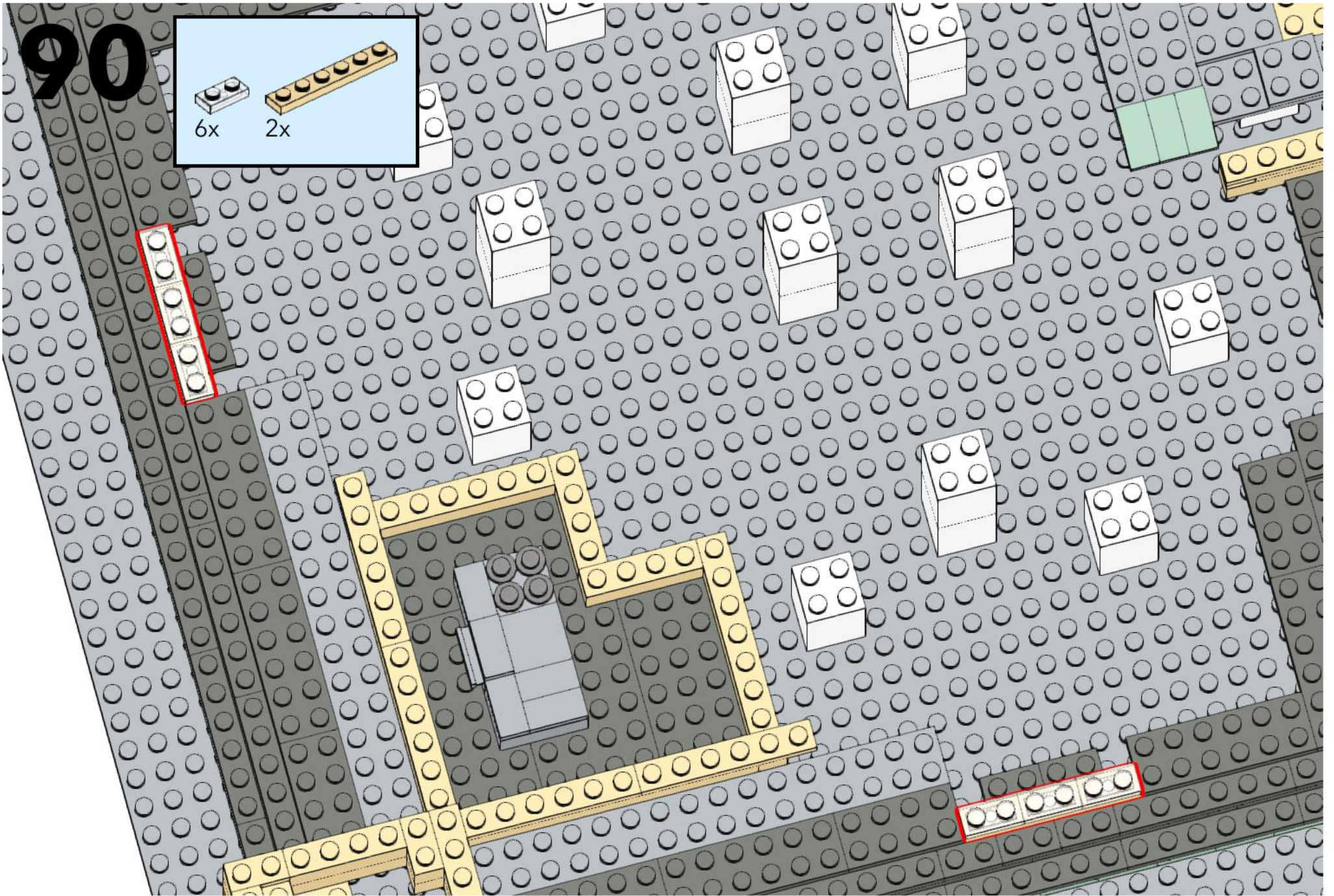
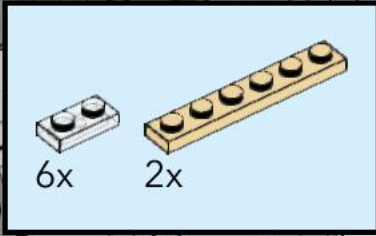

91

2x 4x

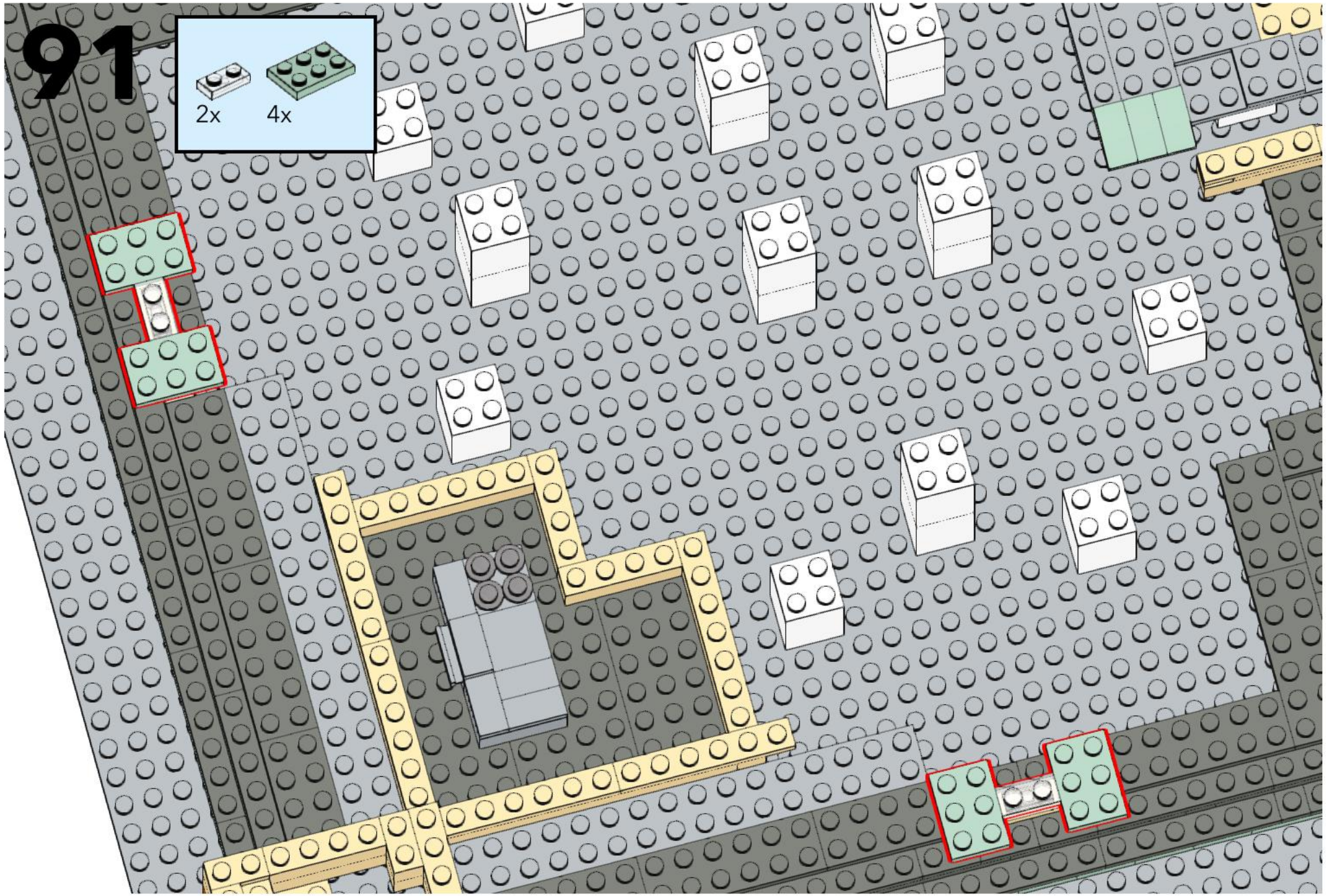
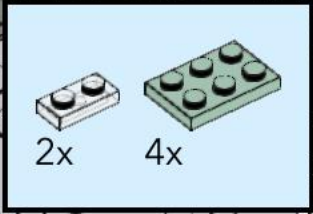

# 92

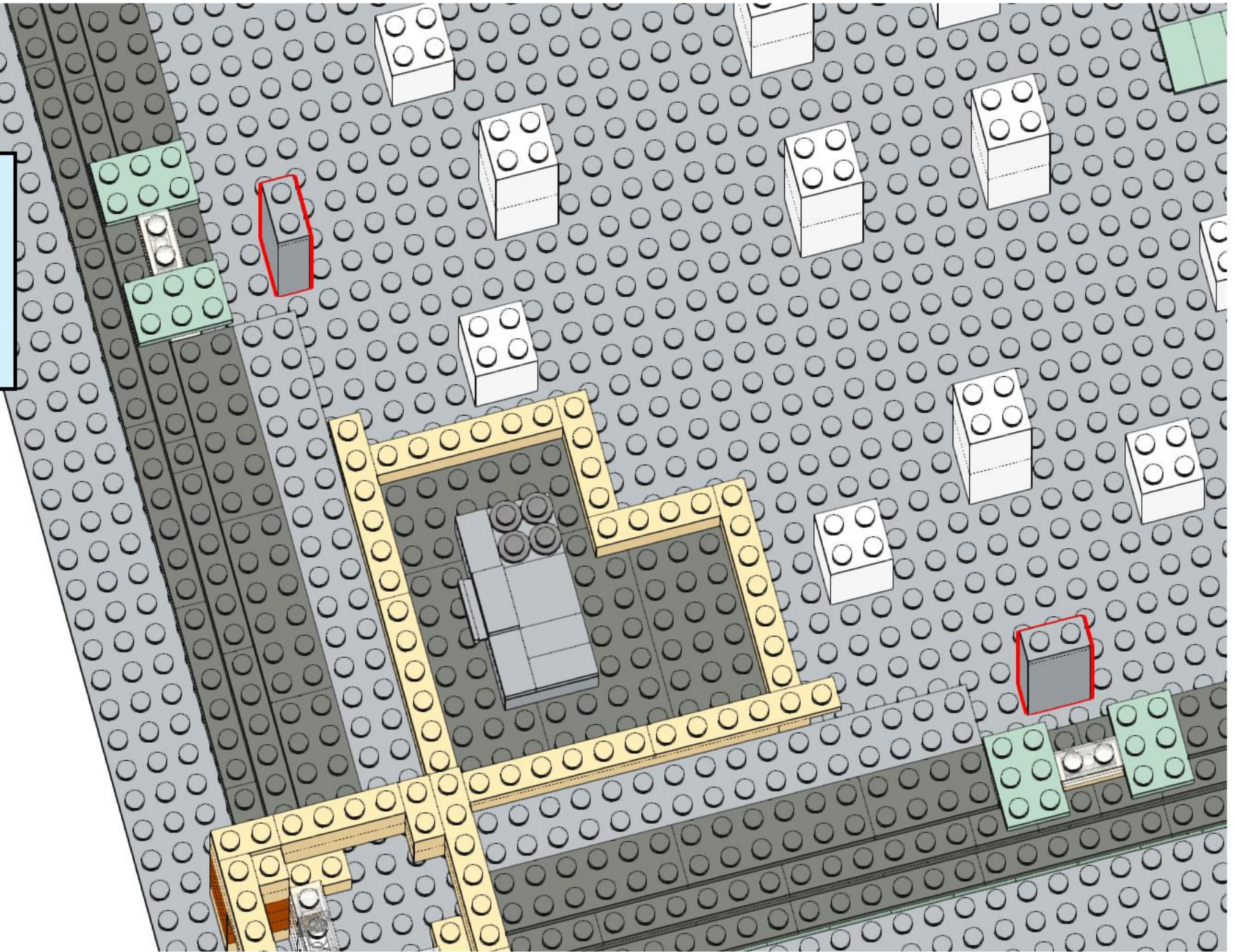
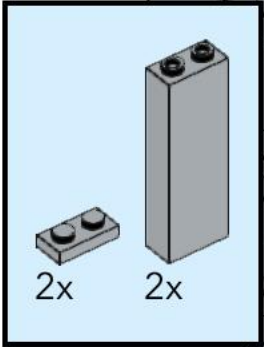

93

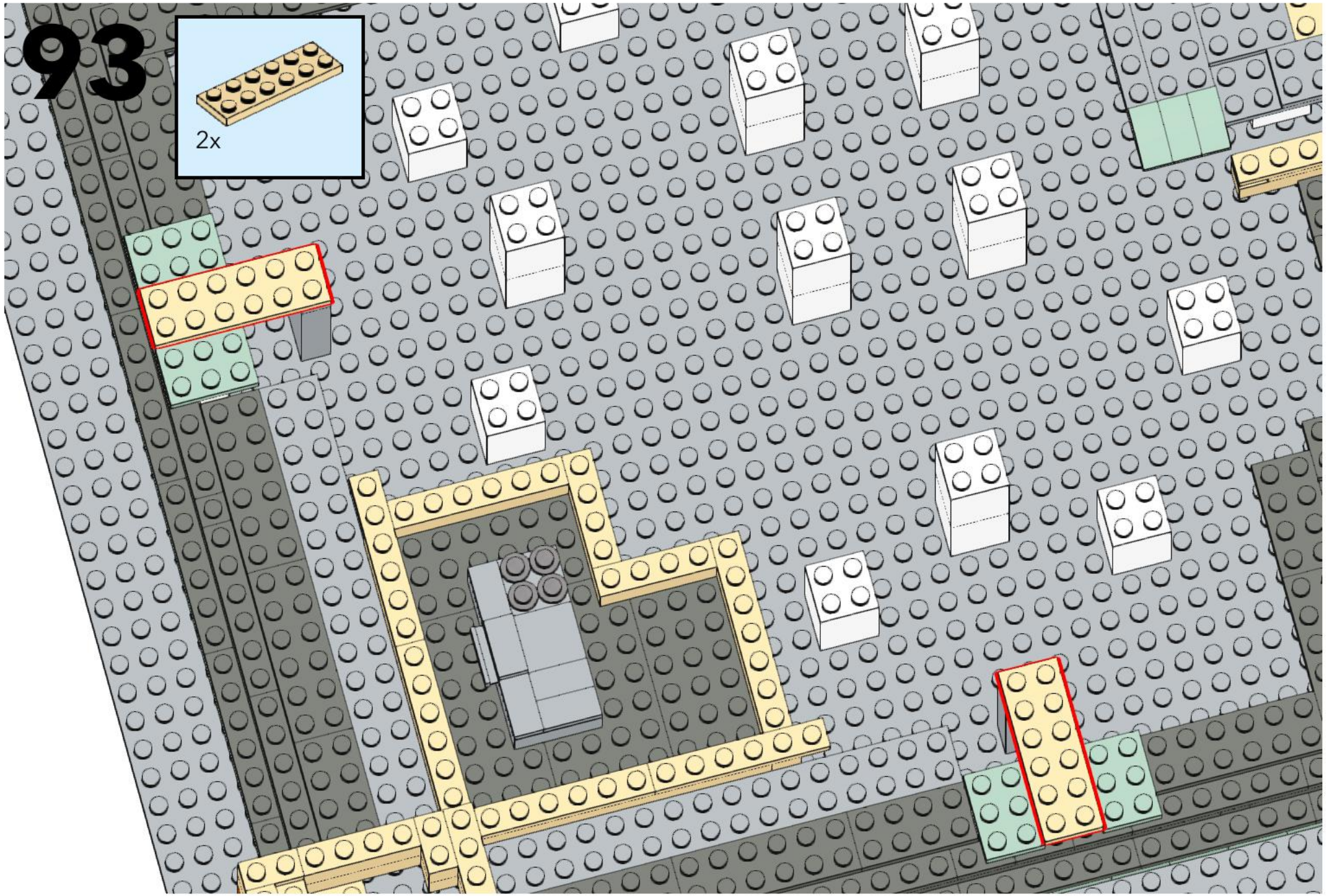
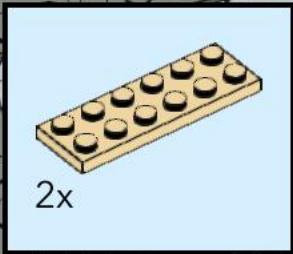

94

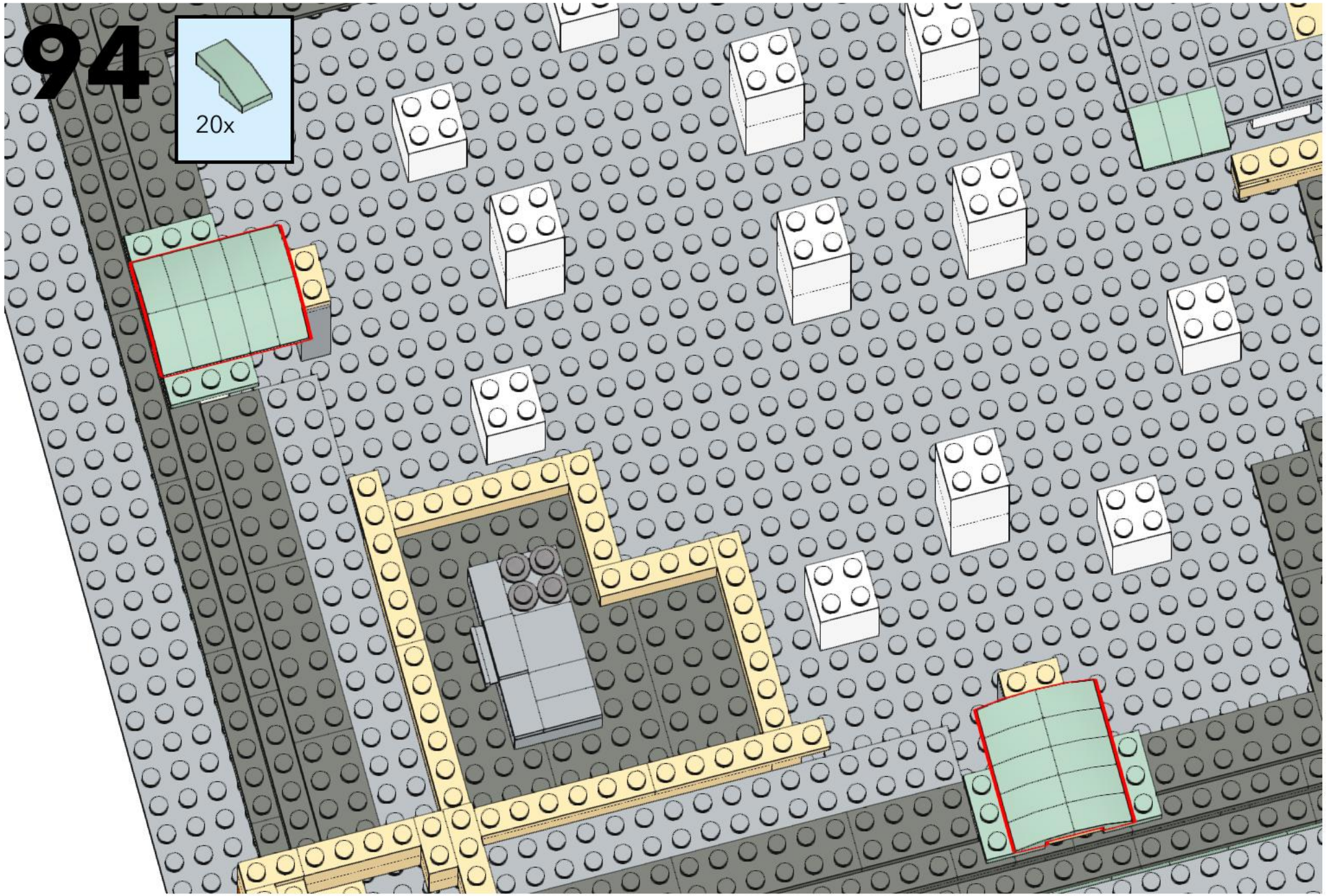
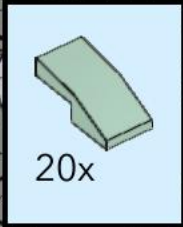

95

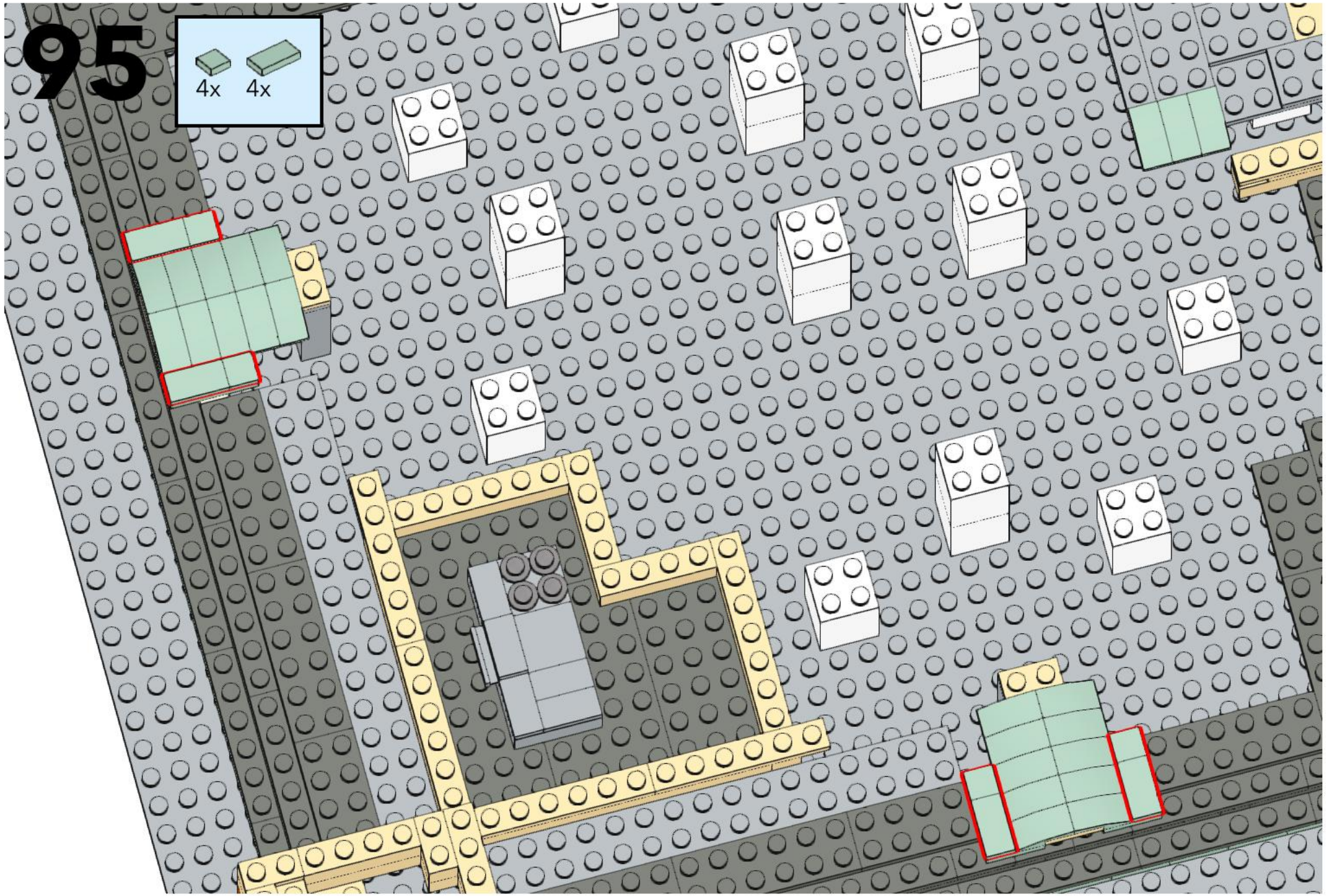
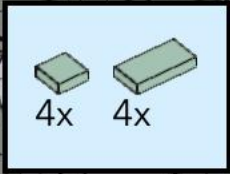



96

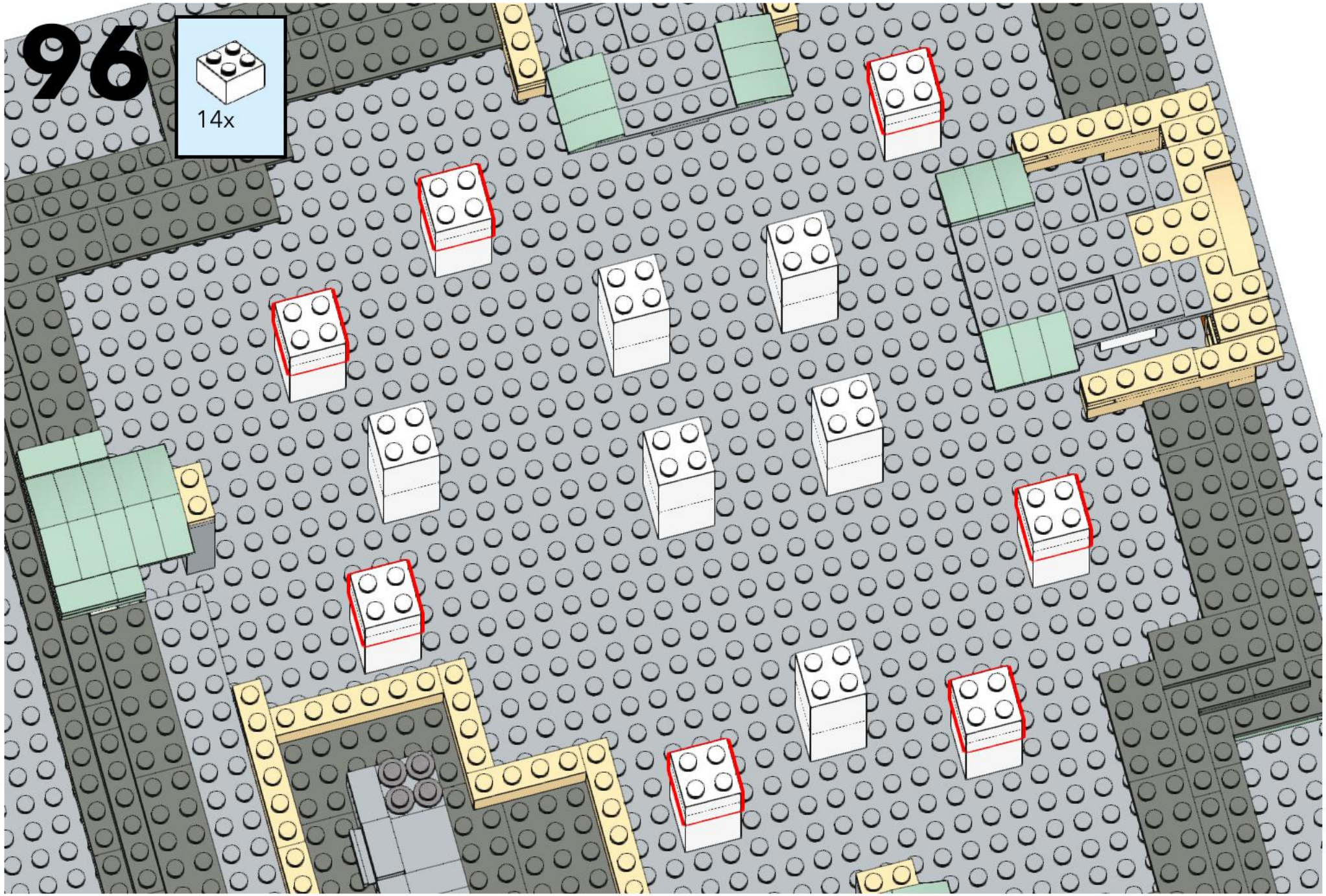
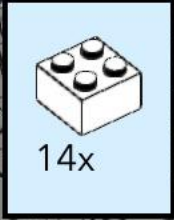

# 97

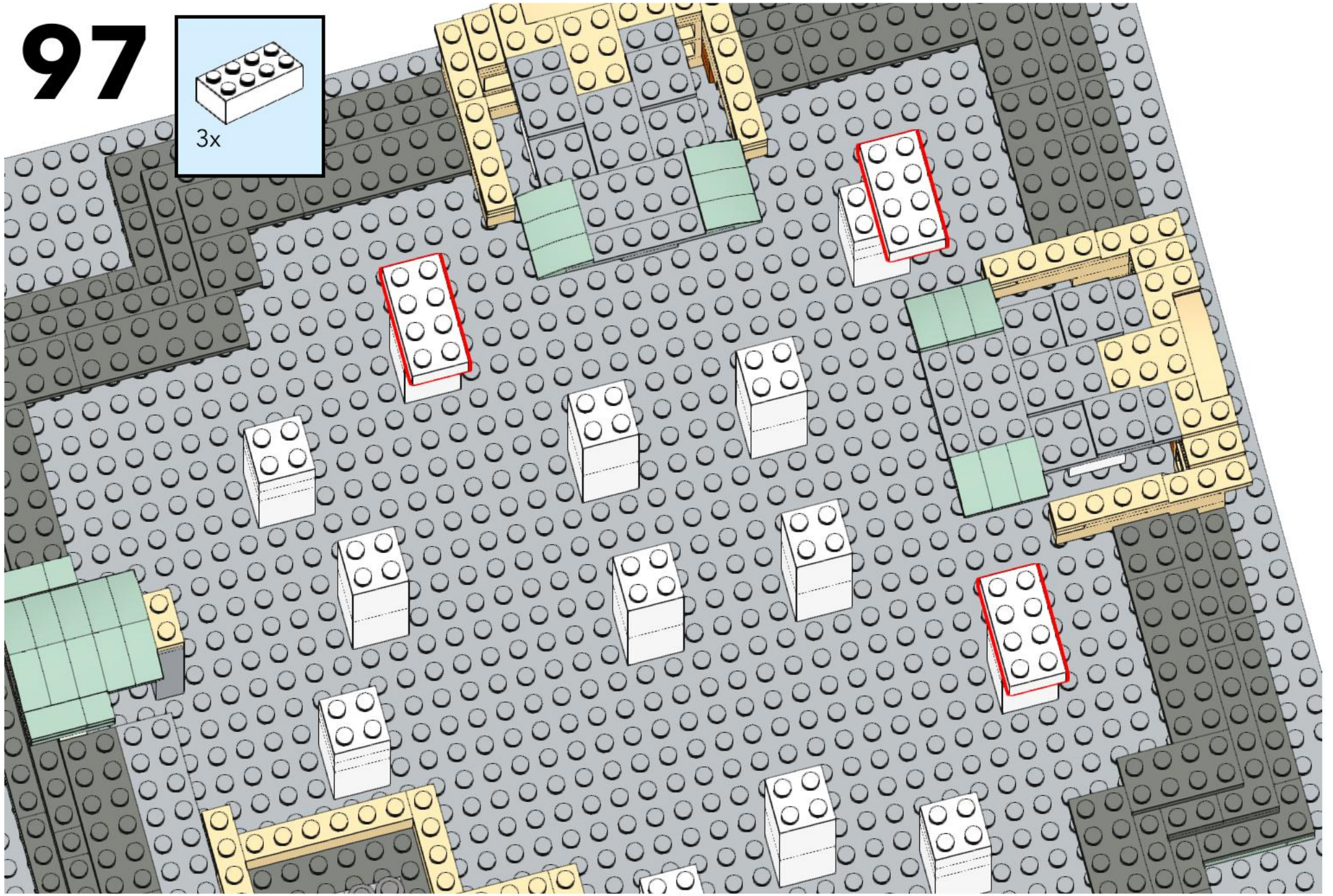
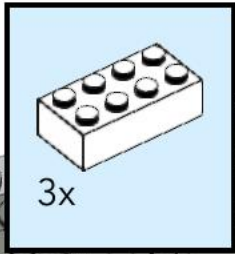

# 98

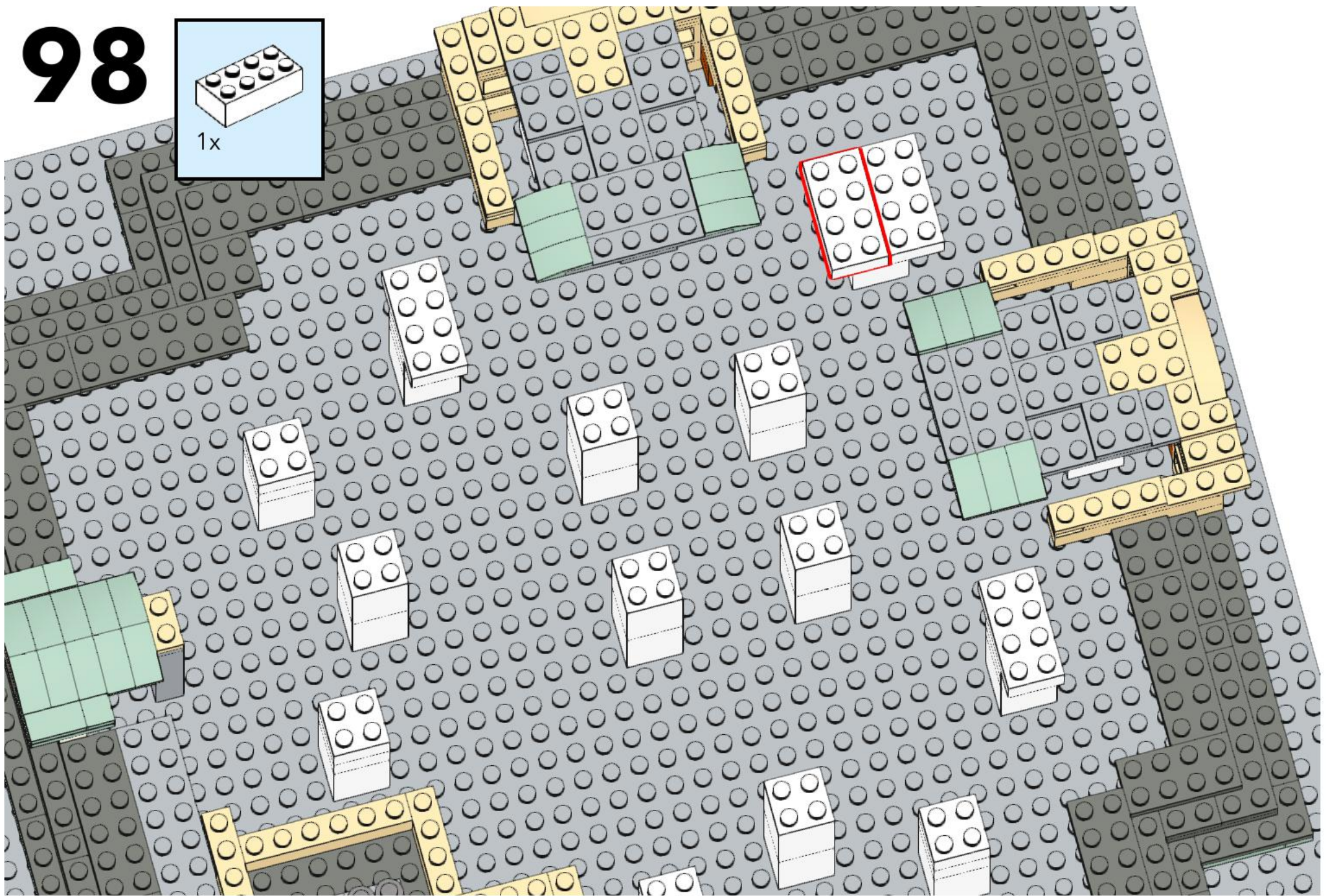
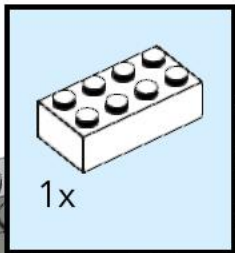

99

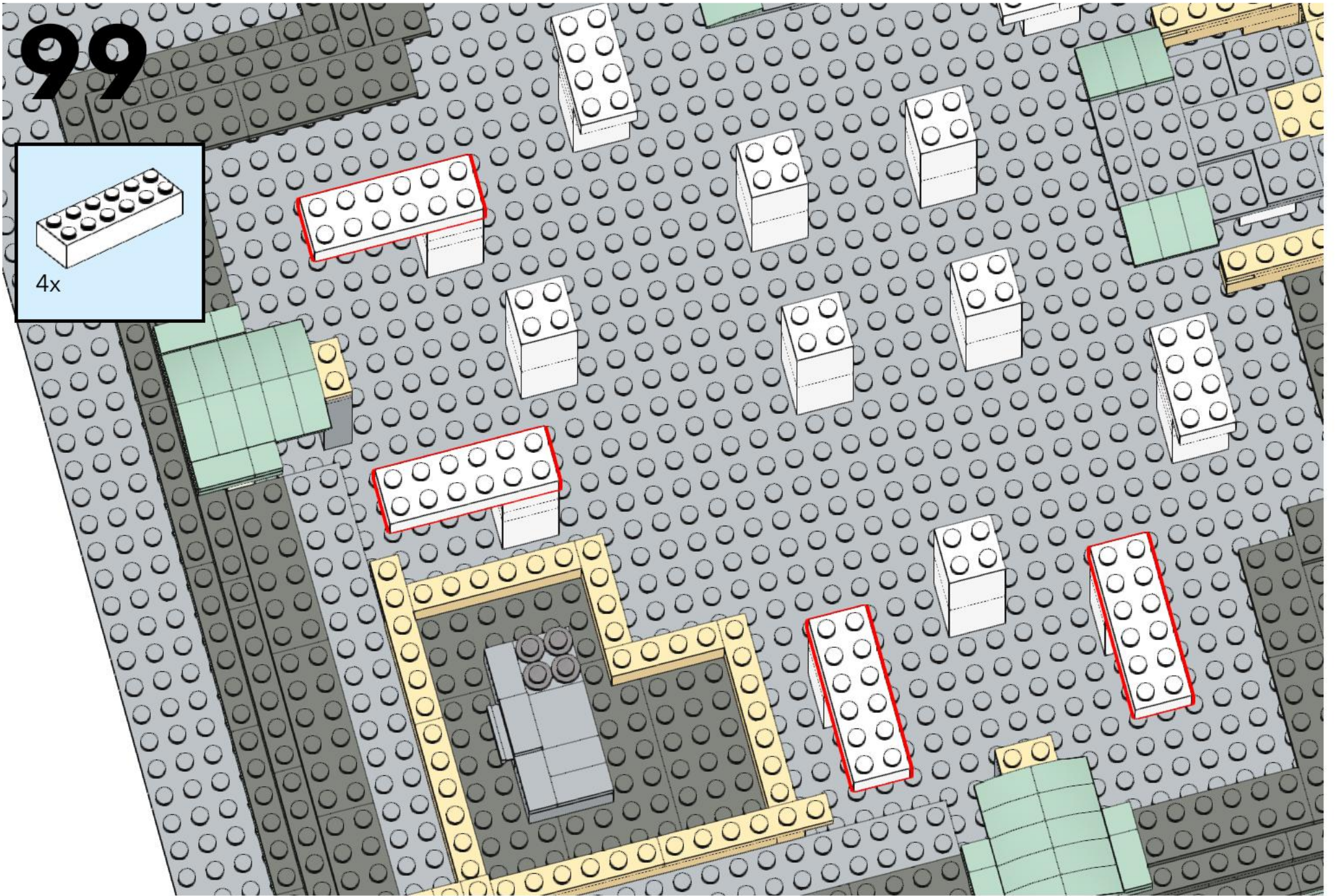
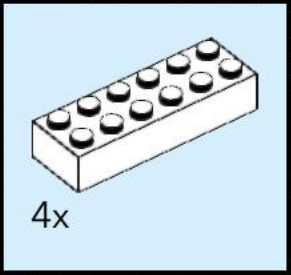

# 100

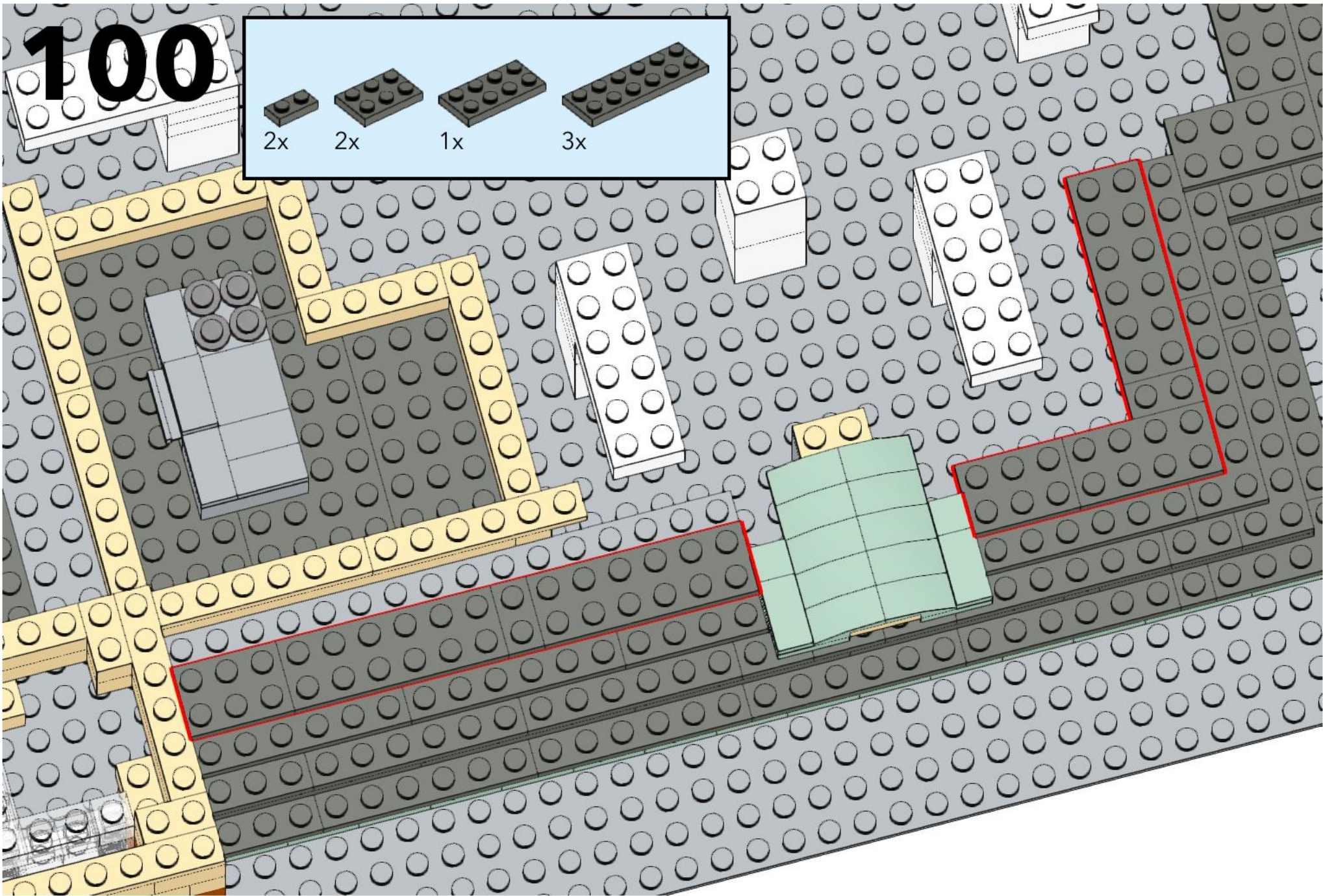
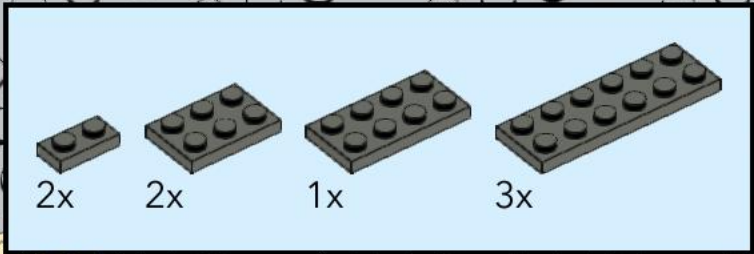

# 101

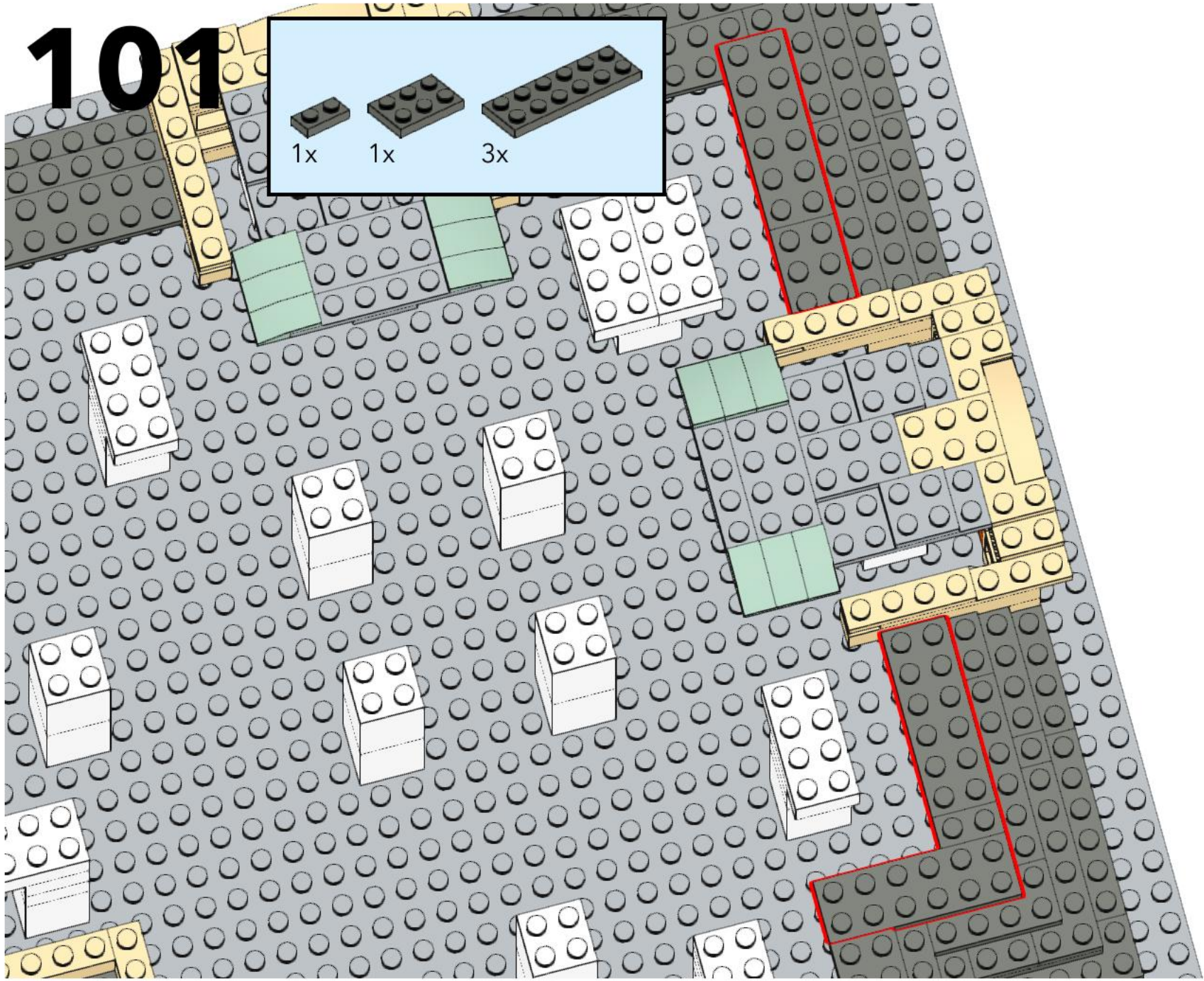
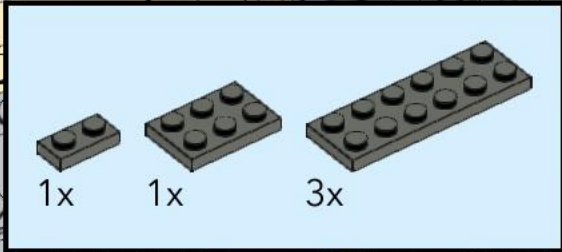

# 102

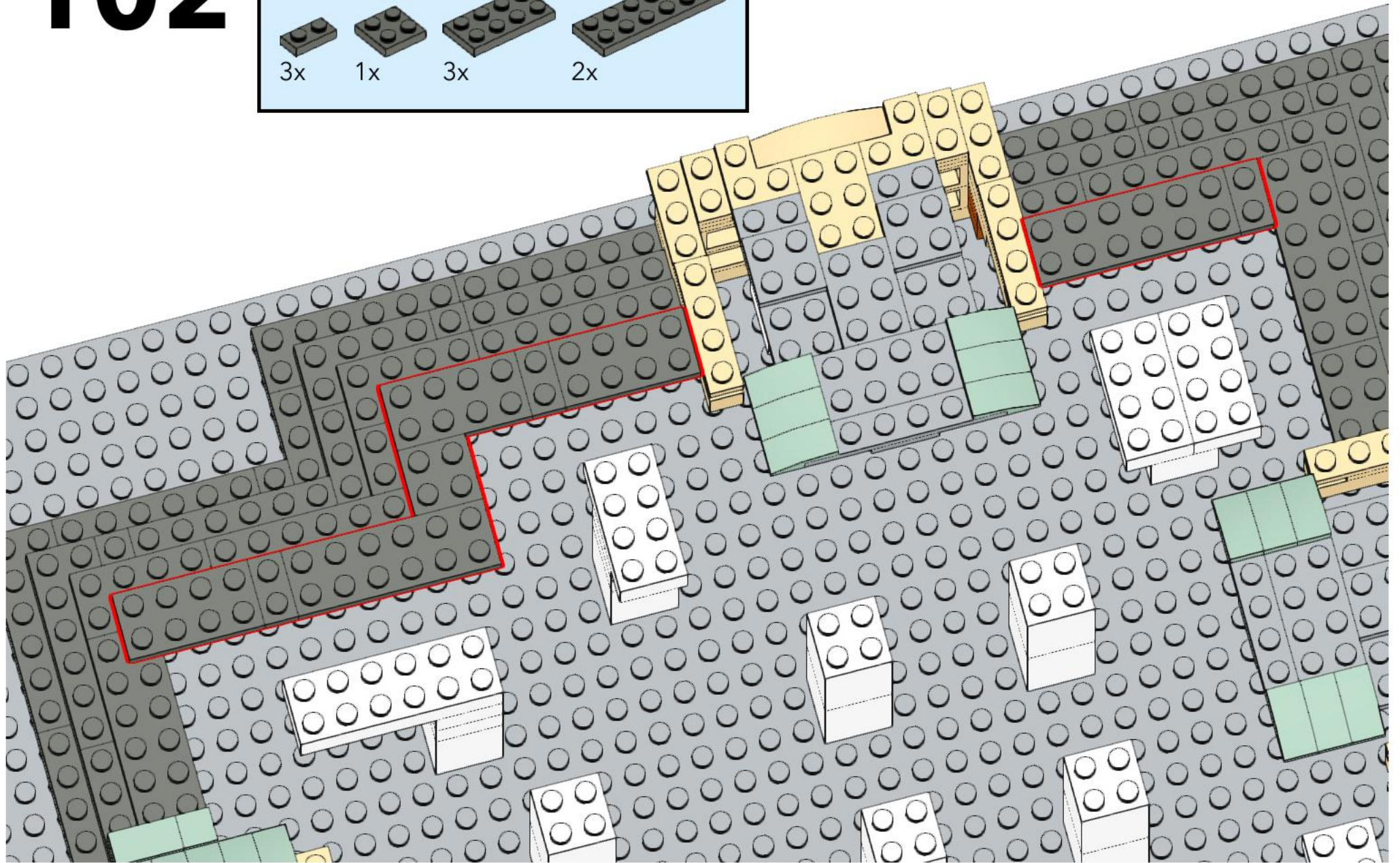
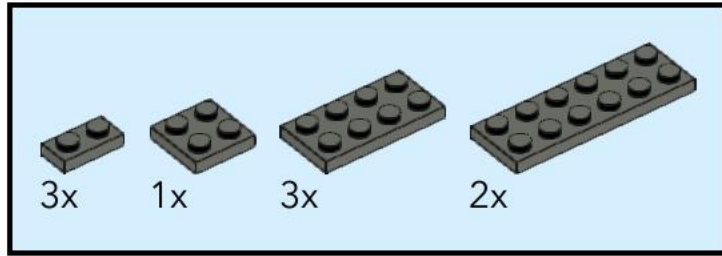

# 103

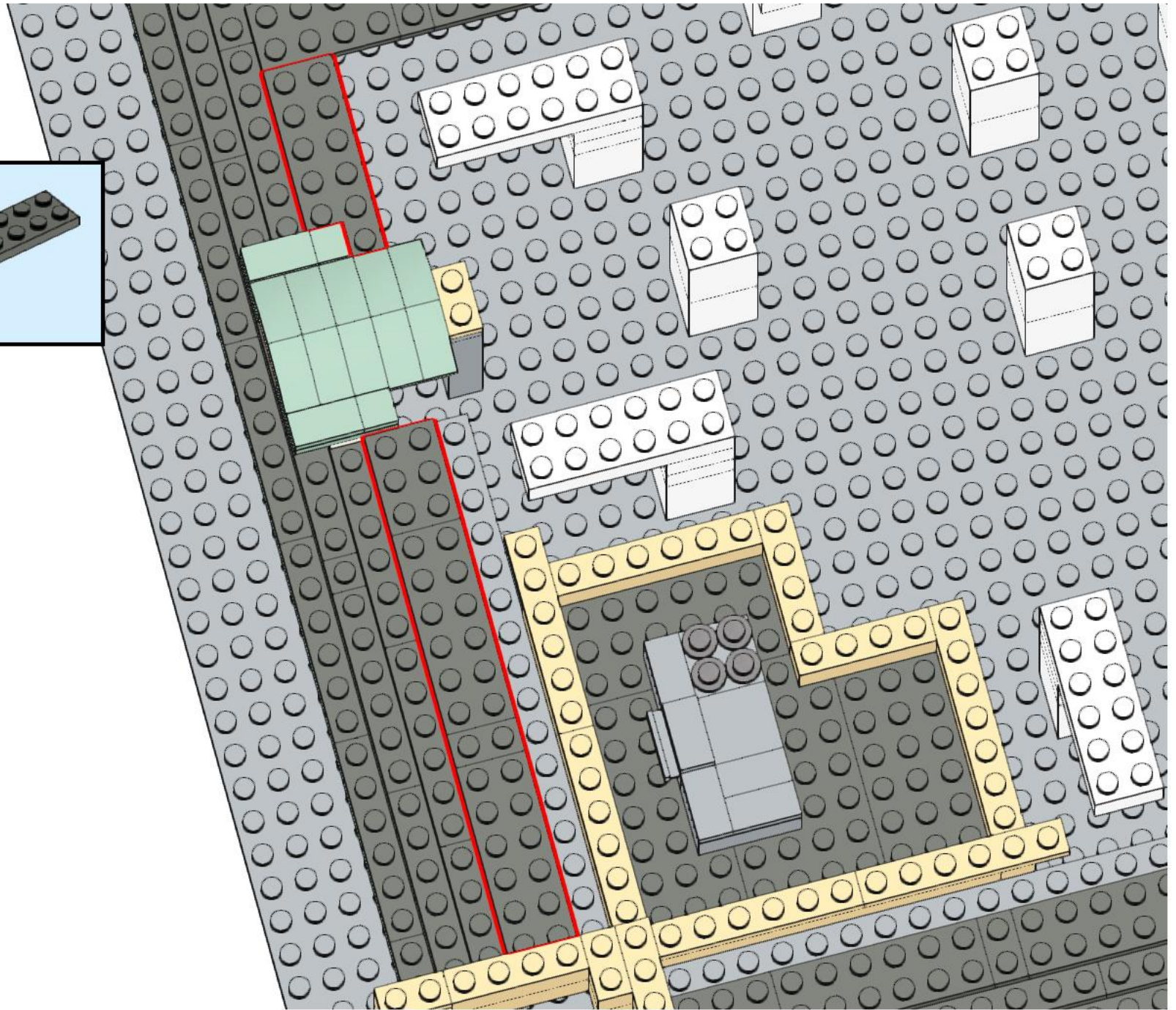
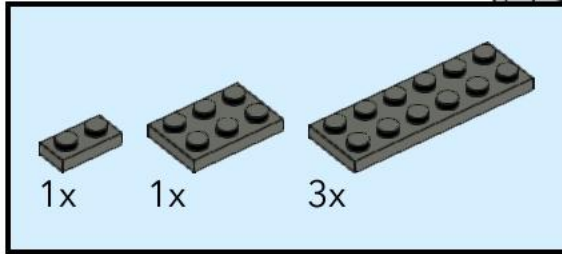



# 104

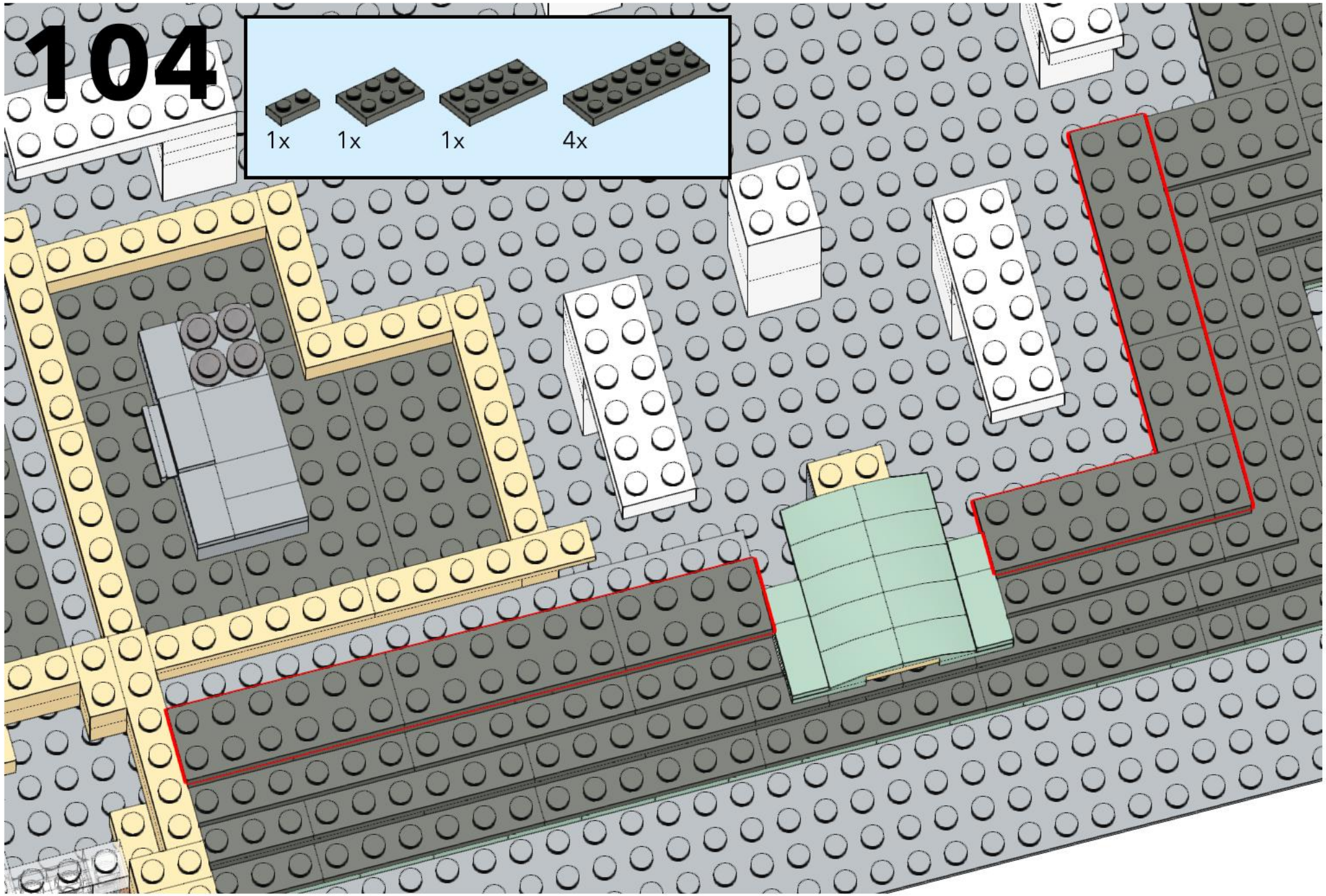
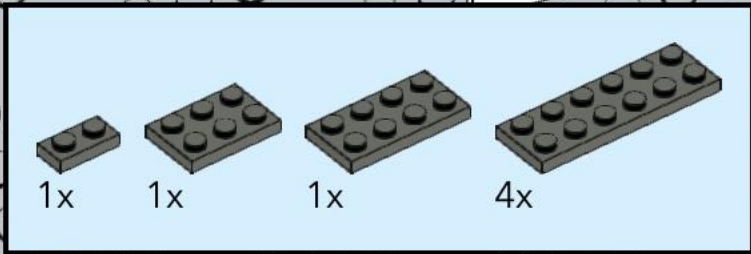

# 105

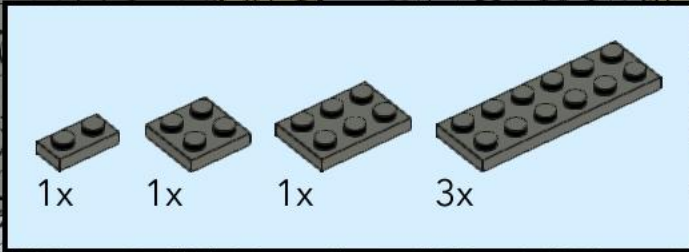

1x 1x 1x 3x

This inset box lists the required parts for step 105: one 1x2 dark grey brick, one 1x3 dark grey brick, one 1x4 dark grey brick, and three 1x6 dark grey bricks.

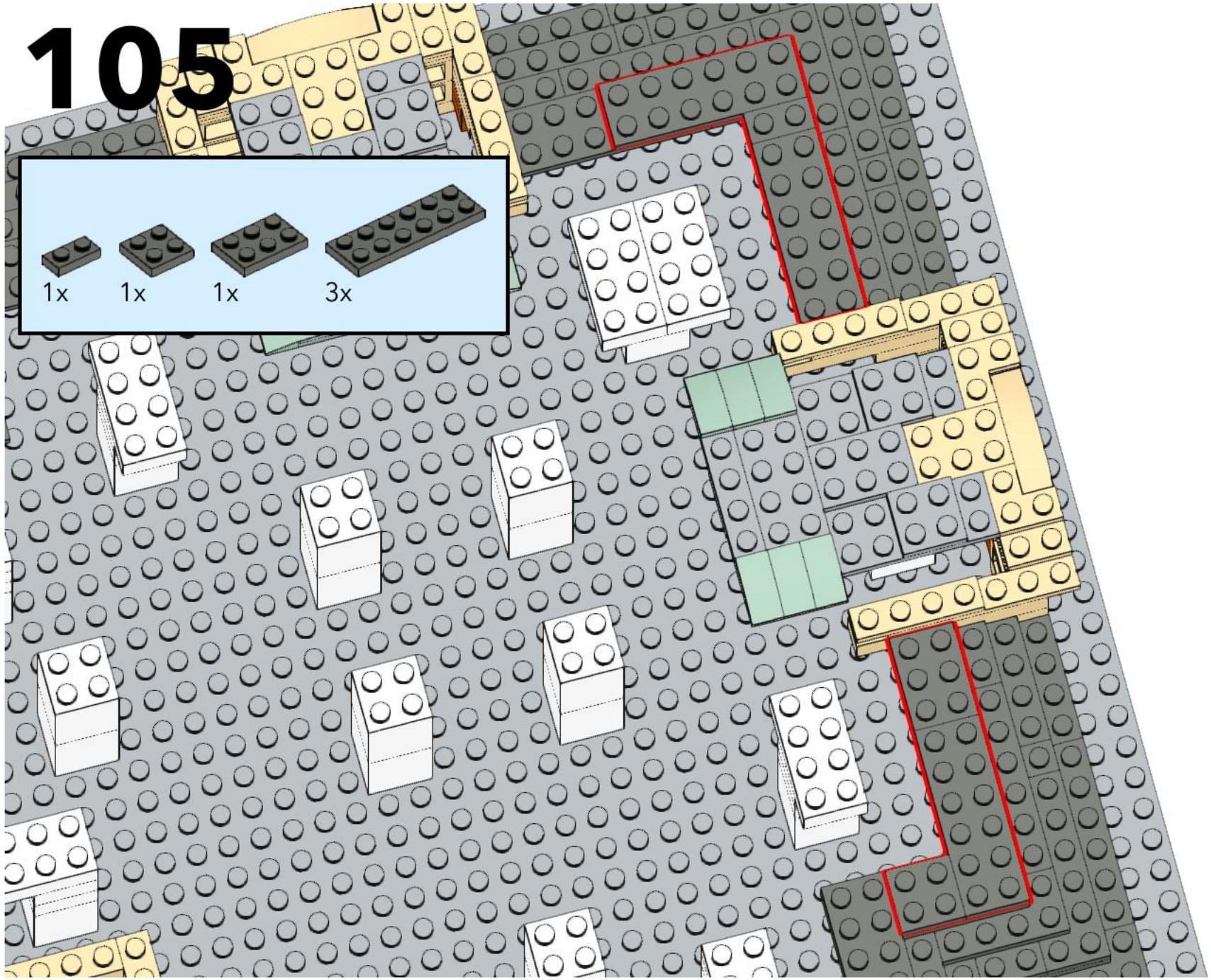

# 106

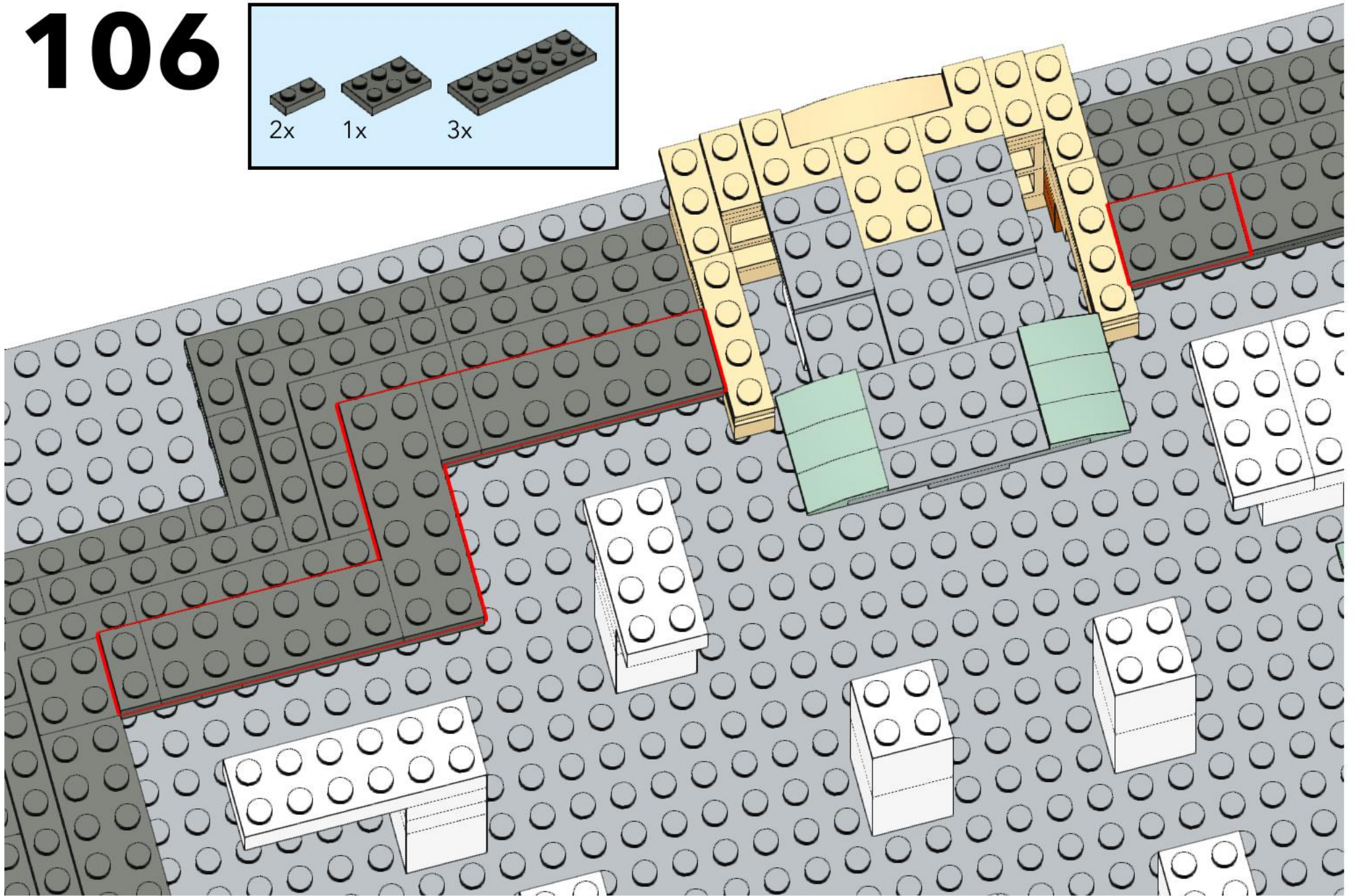
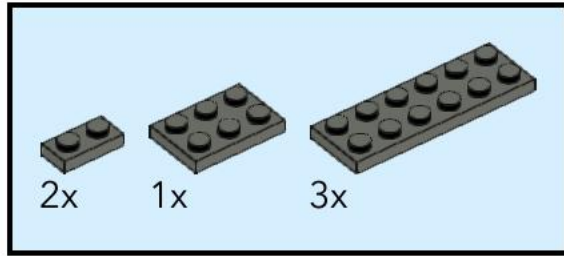

# 107

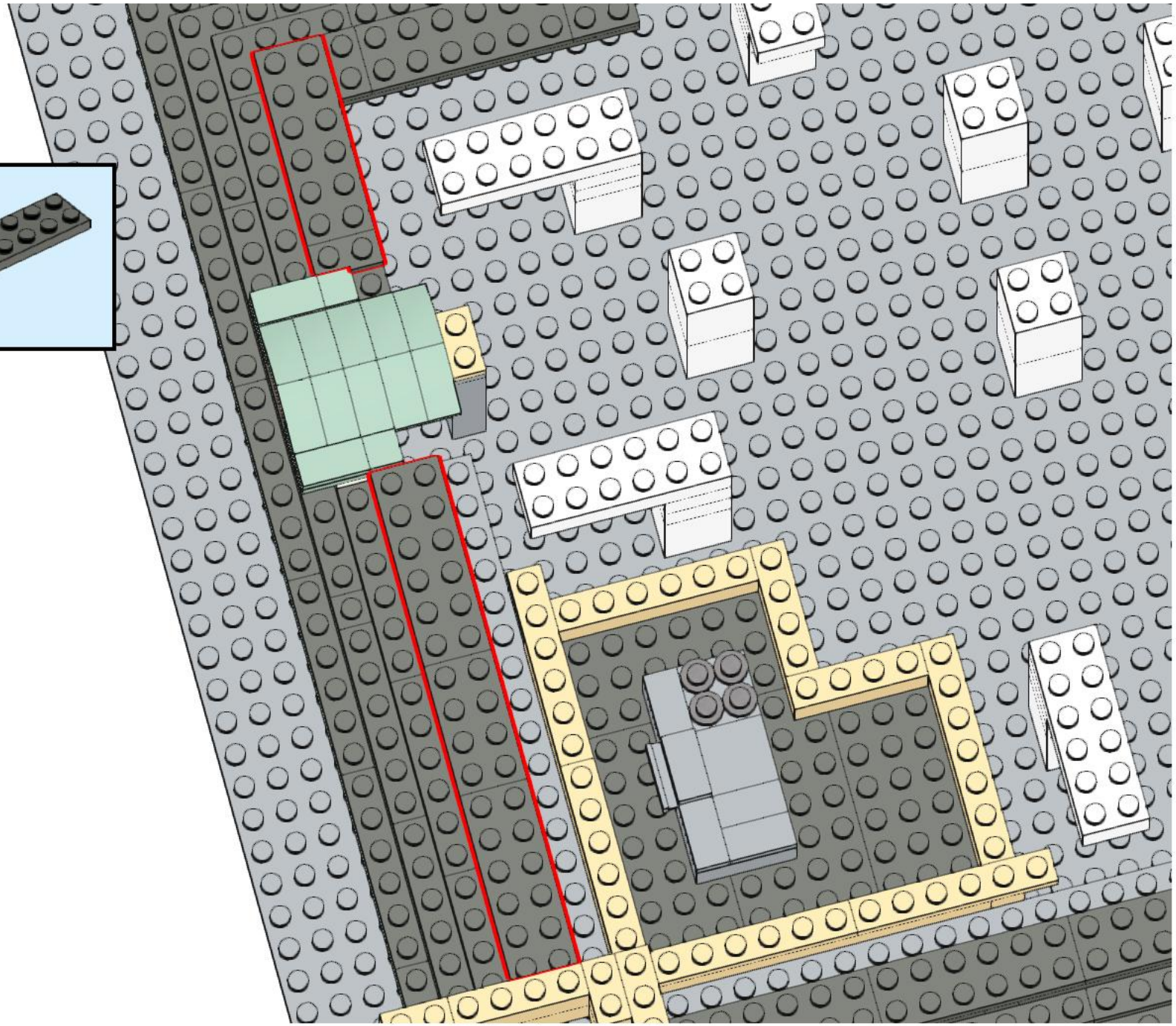
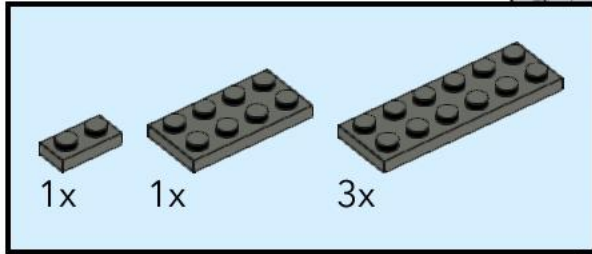

# 108

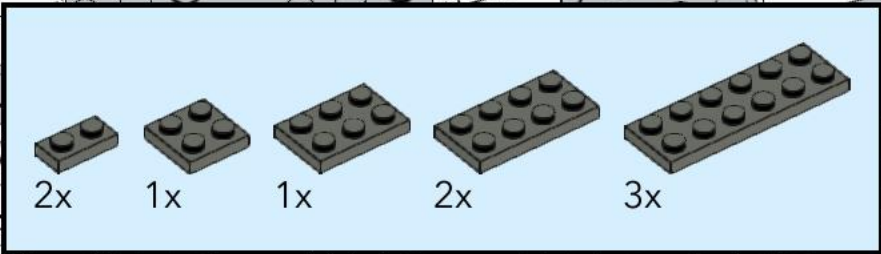

2x 1x 1x 2x 3x

A light blue rectangular box containing five dark grey LEGO Technic bricks of different lengths. Below each brick is a quantity label: '2x' for the 2-hole brick, '1x' for the 3-hole brick, '1x' for the 4-hole brick, '2x' for the 5-hole brick, and '3x' for the 6-hole brick.

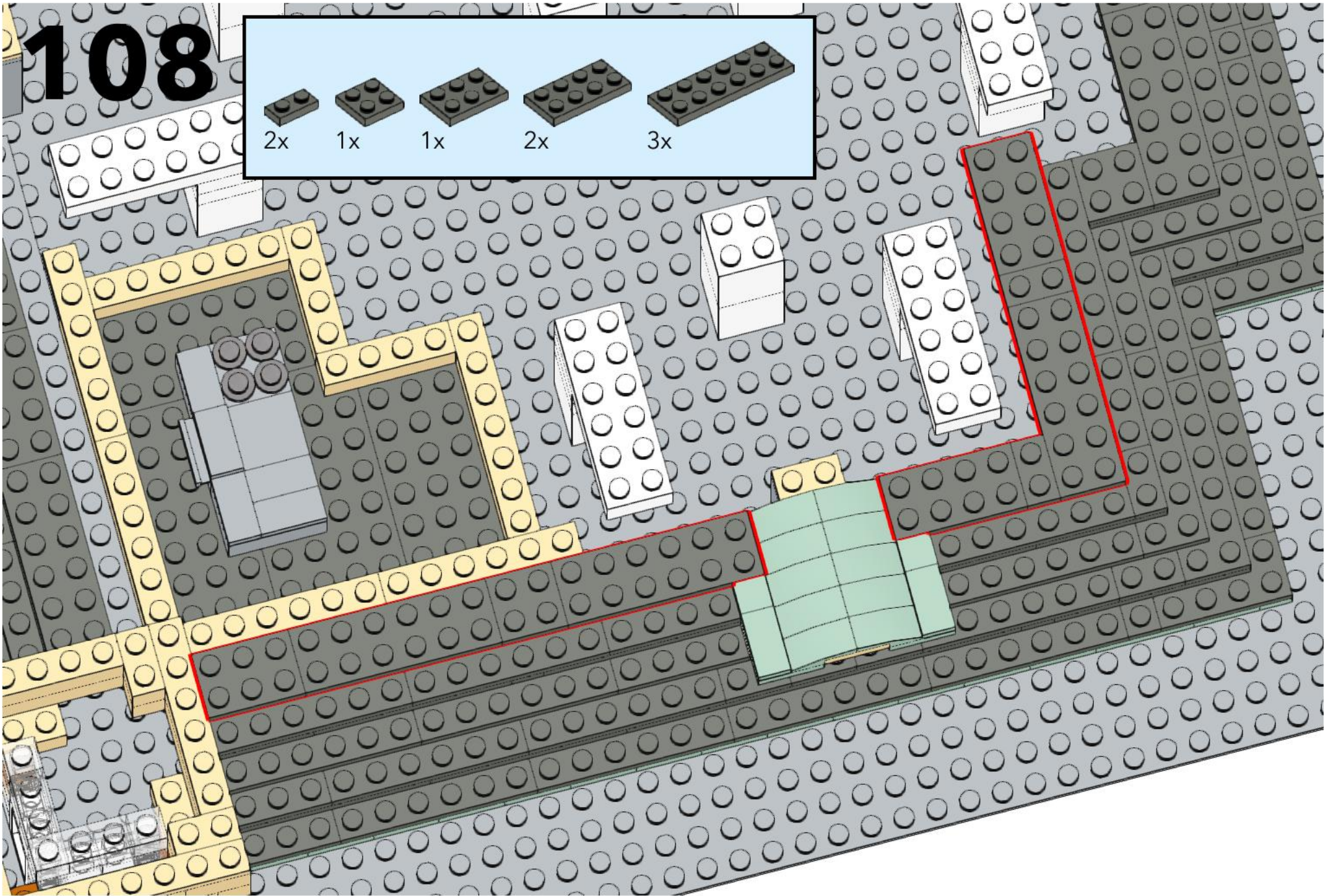

# 109

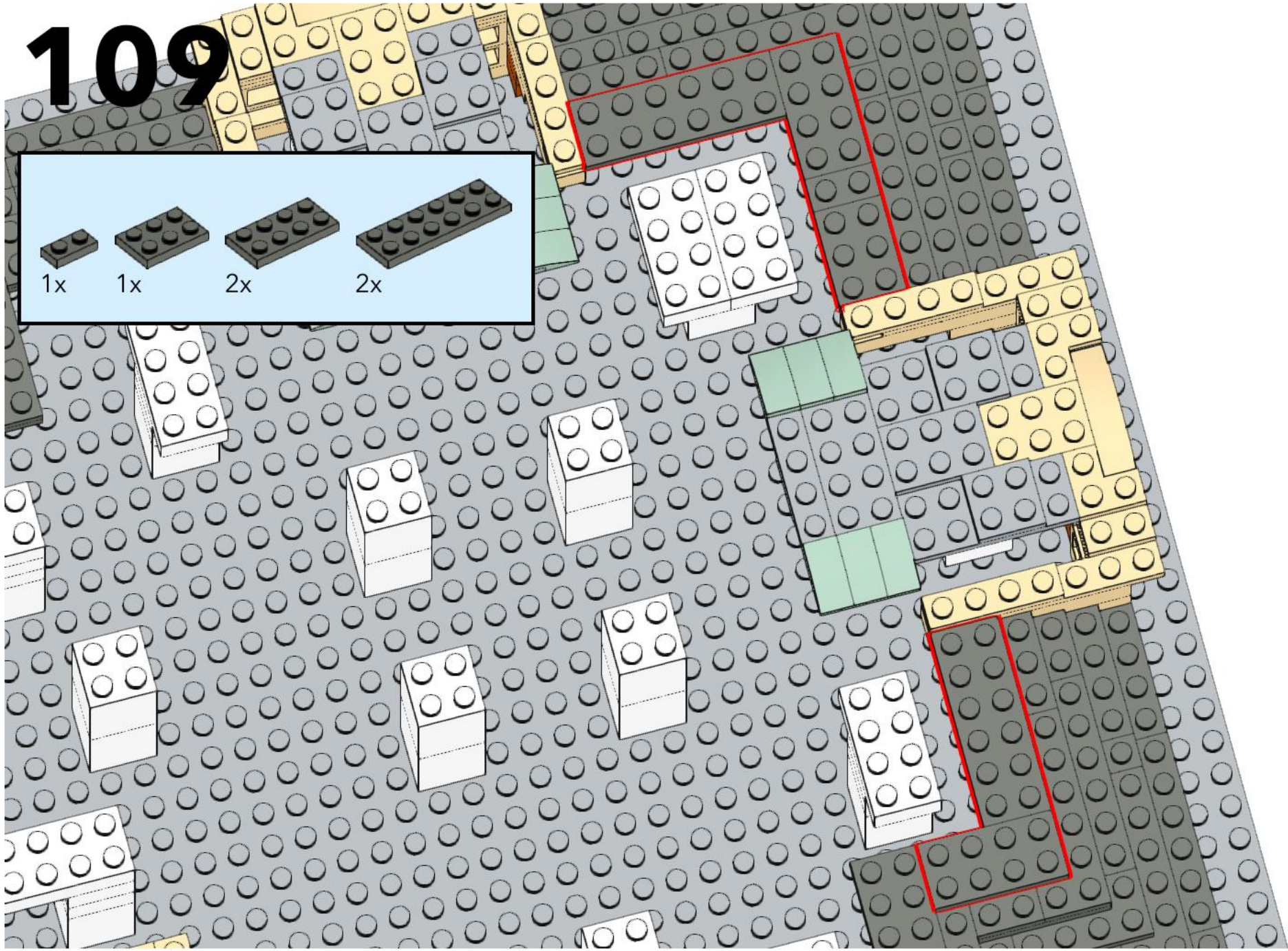
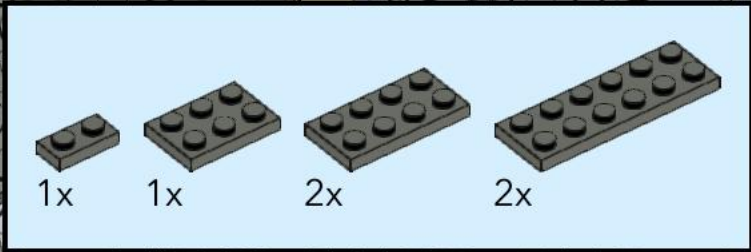

# 110

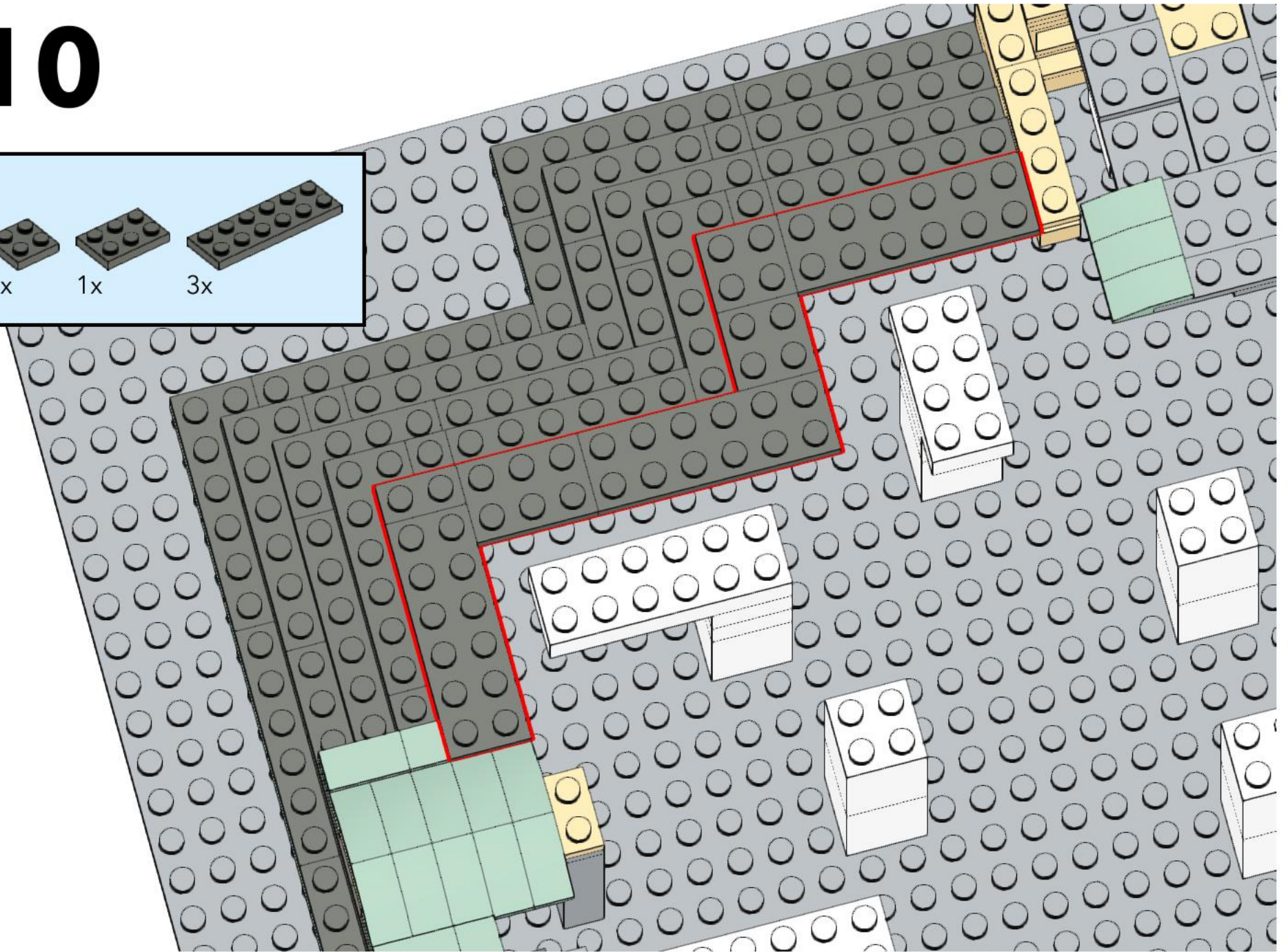
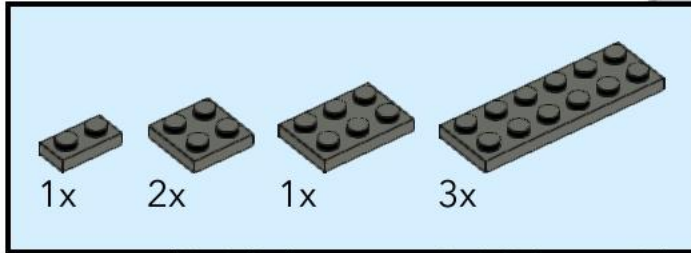

# 111

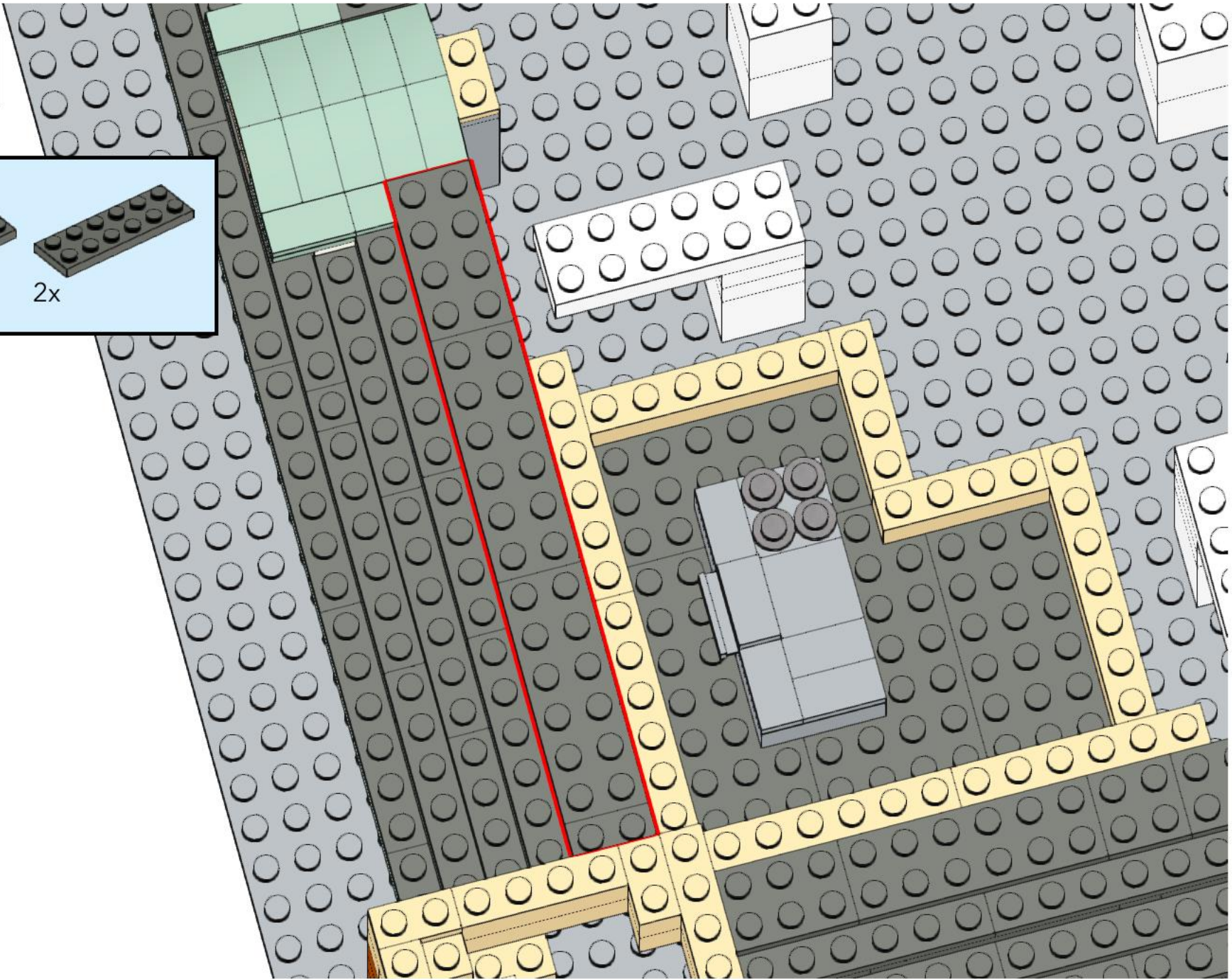
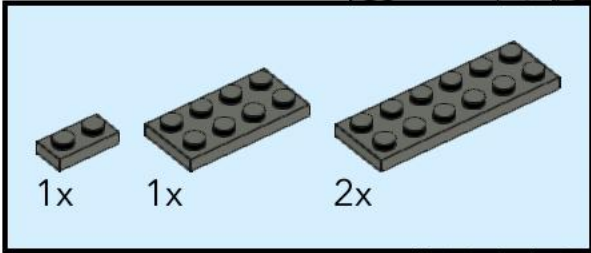



# 112

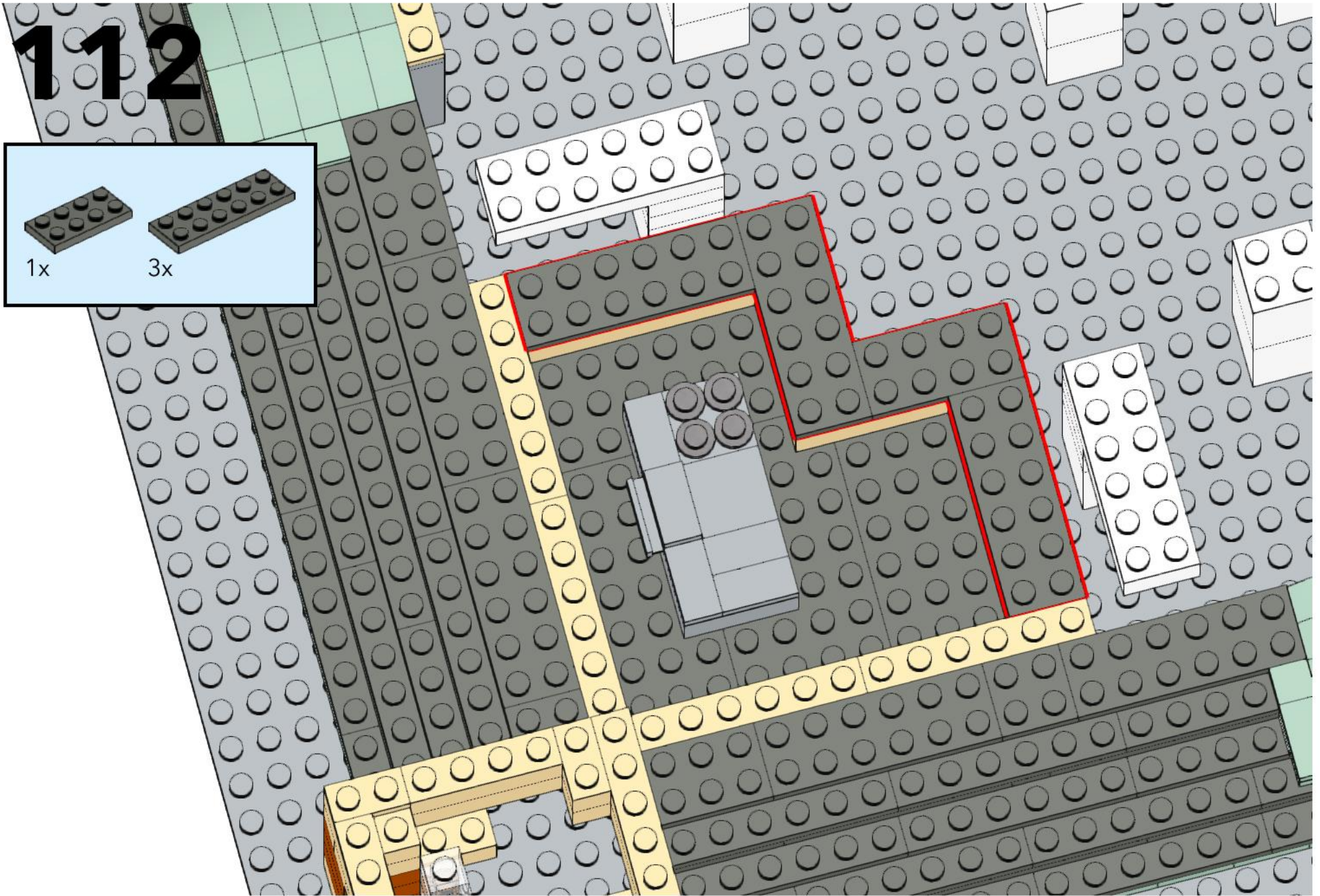
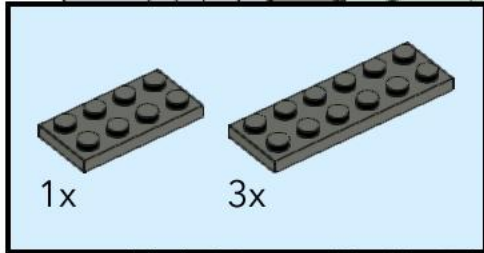

# 113

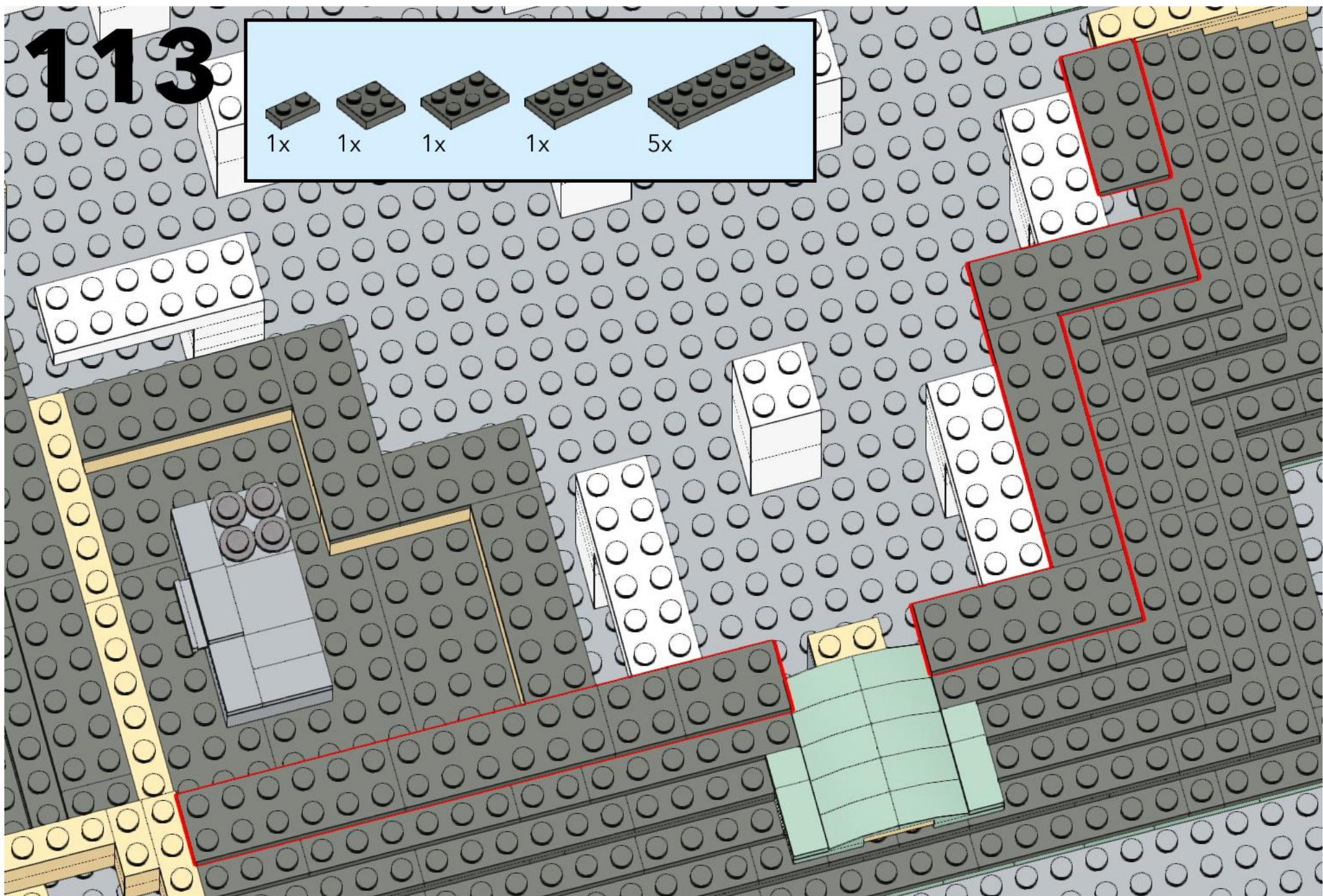
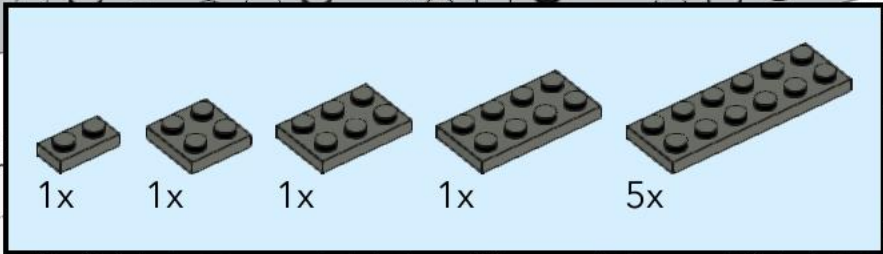

# 114

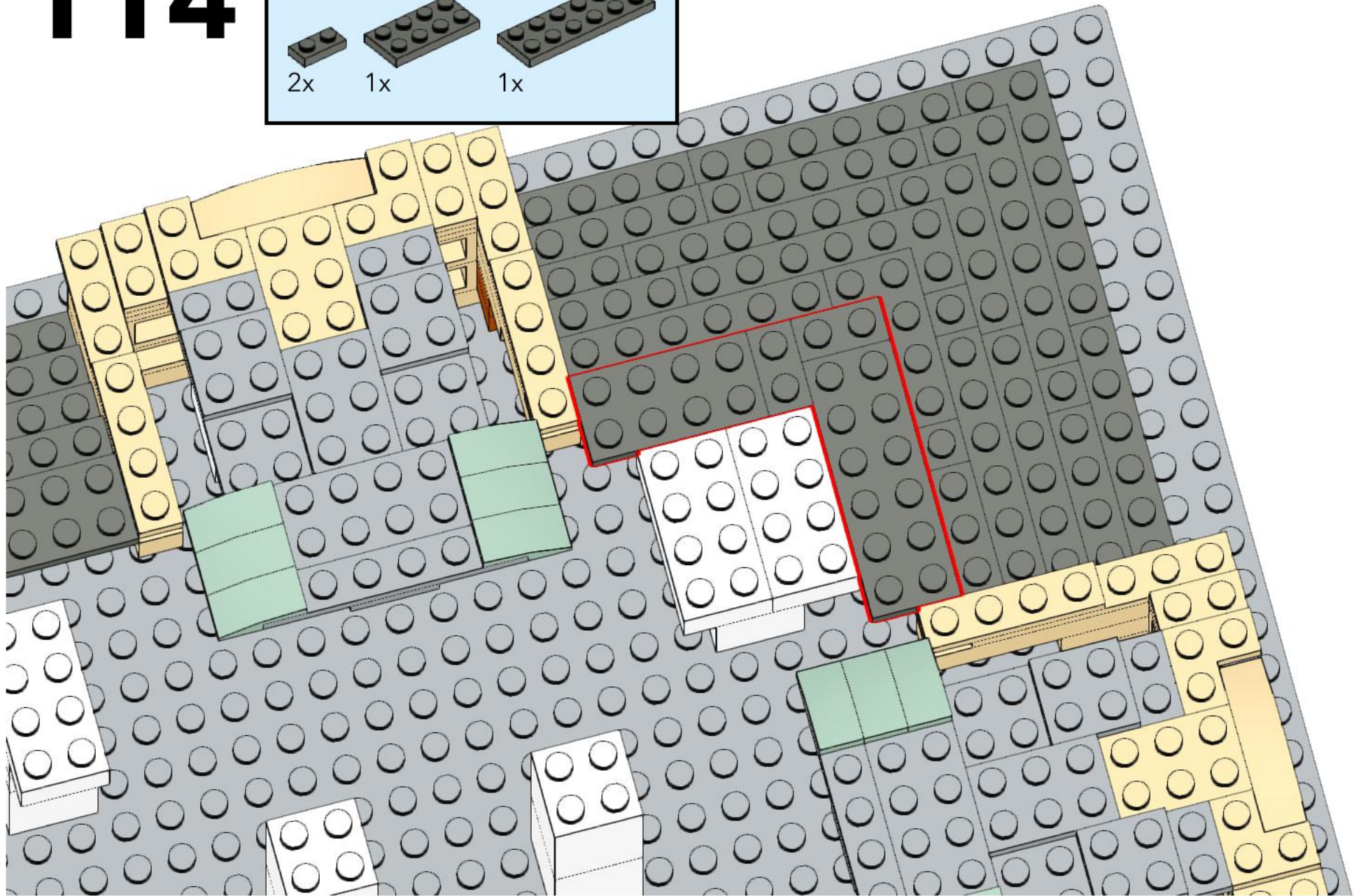
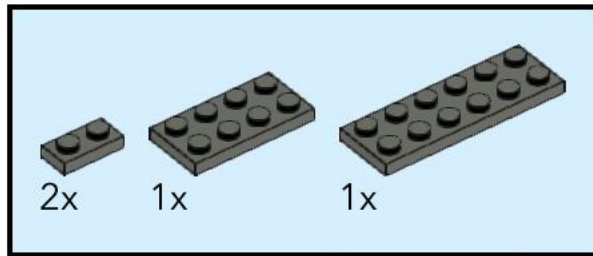

# 115

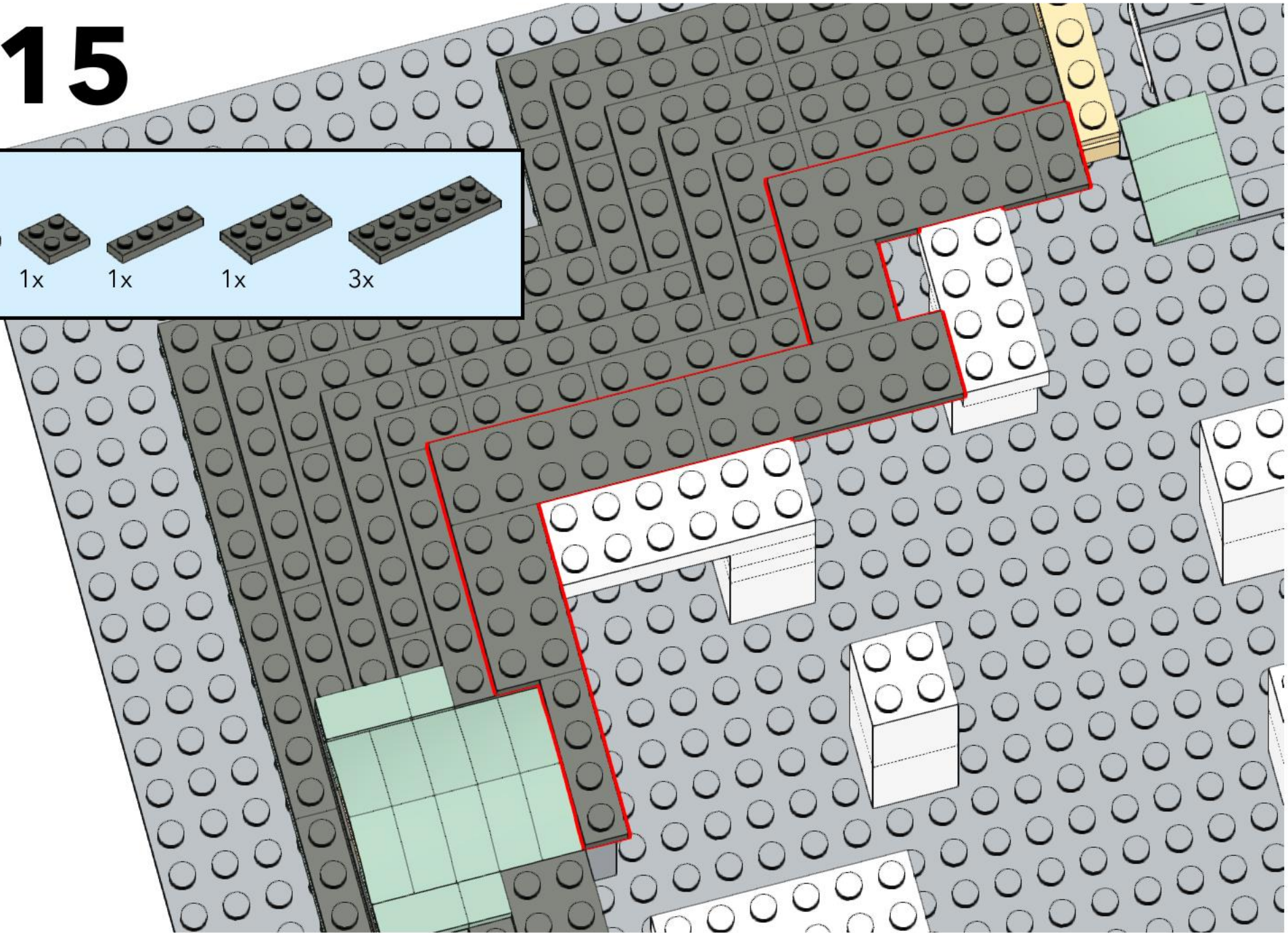
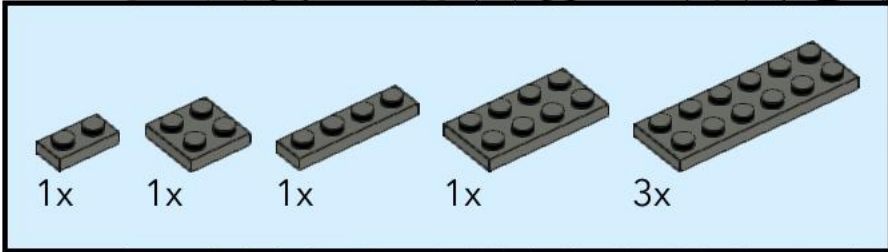

# 116

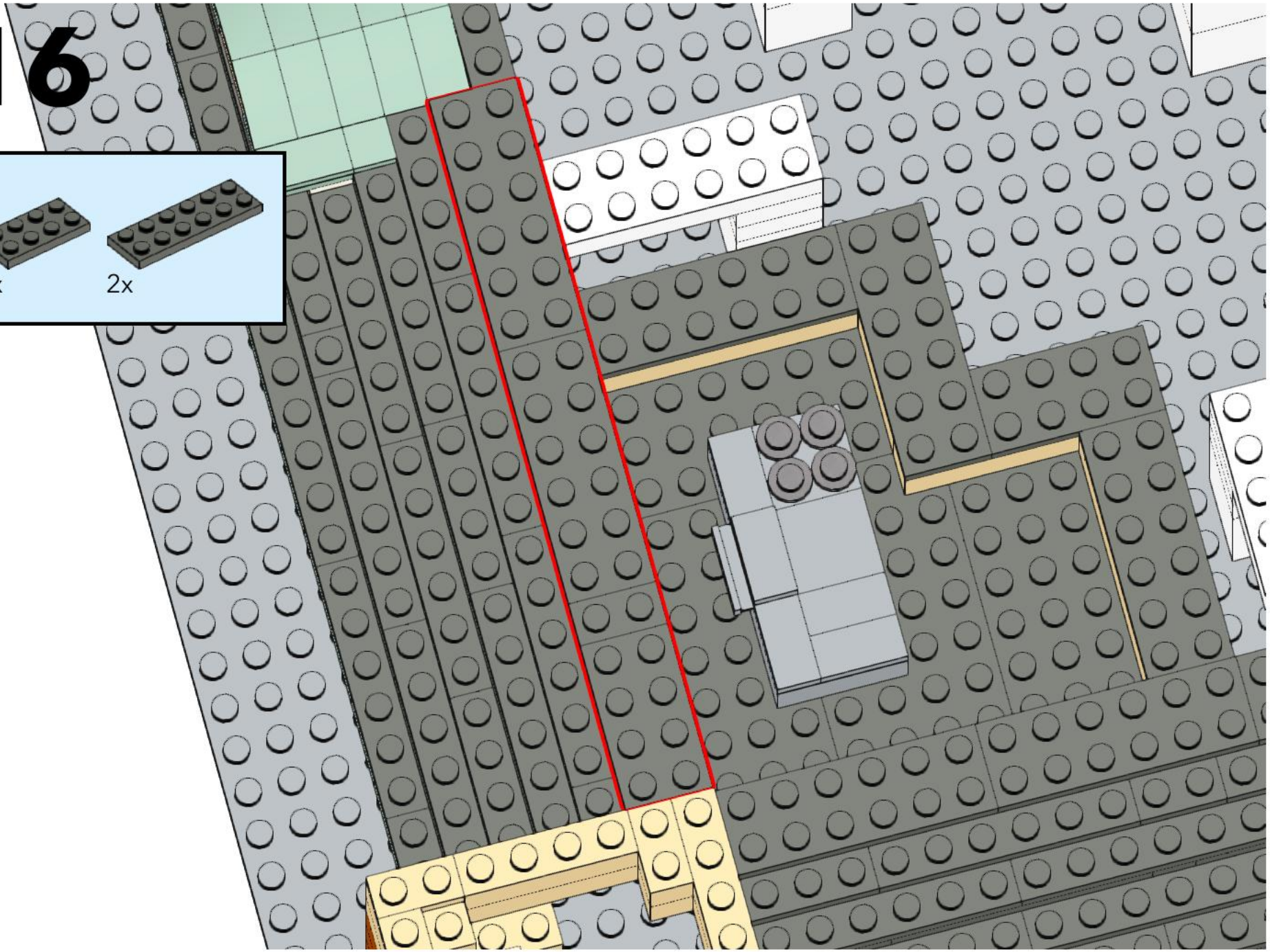
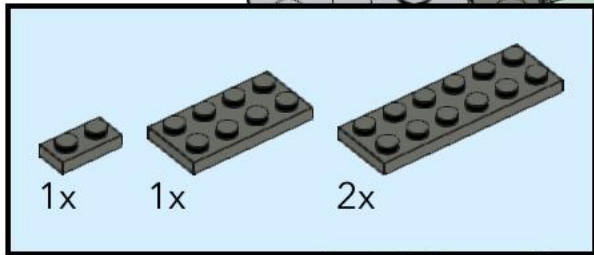

# 117

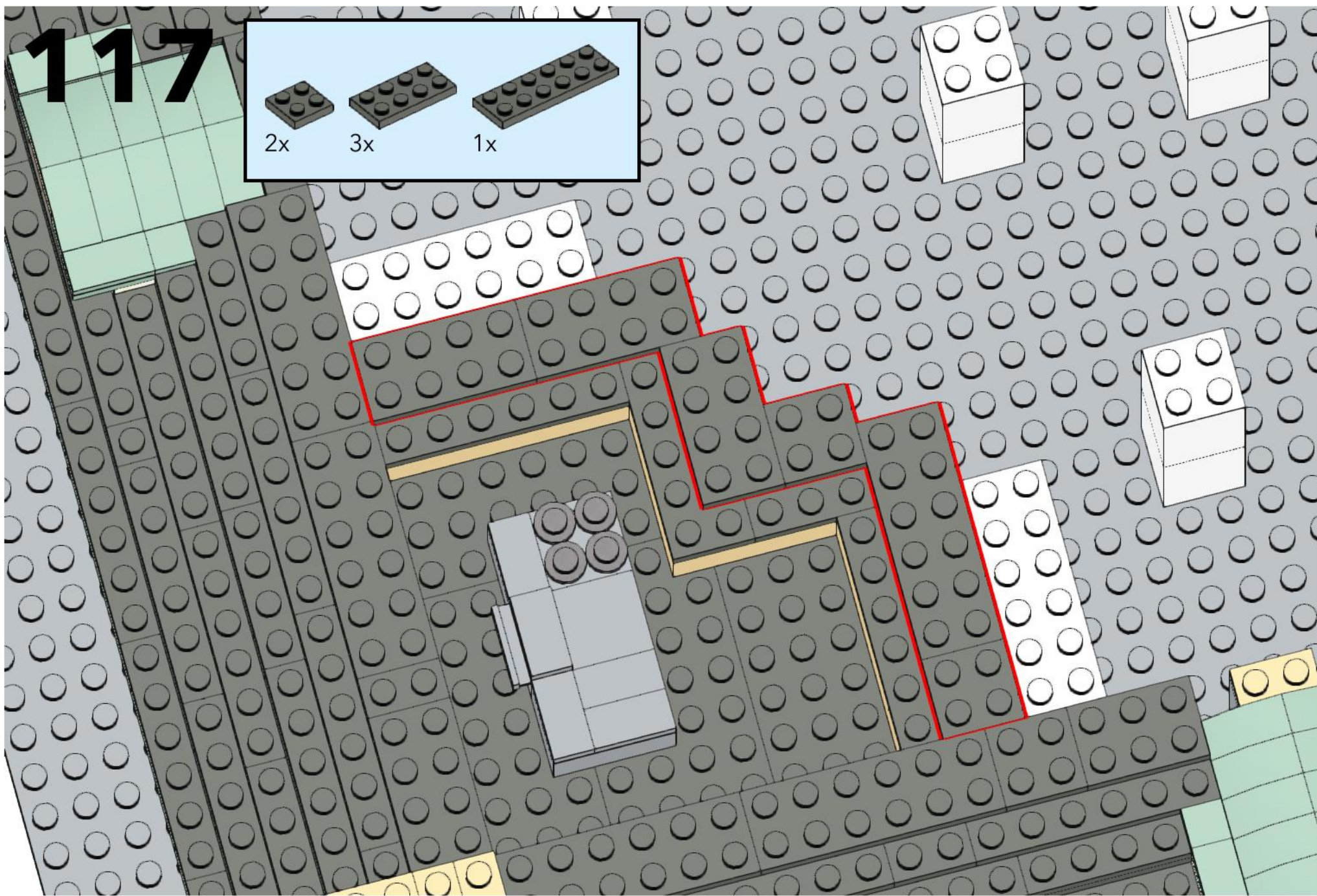
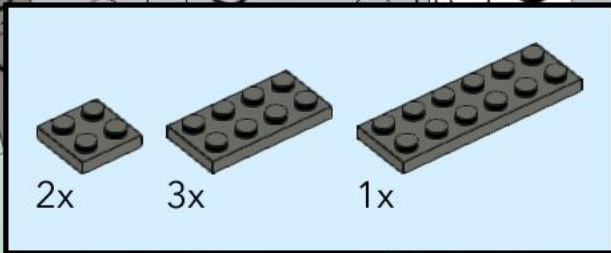

# 118

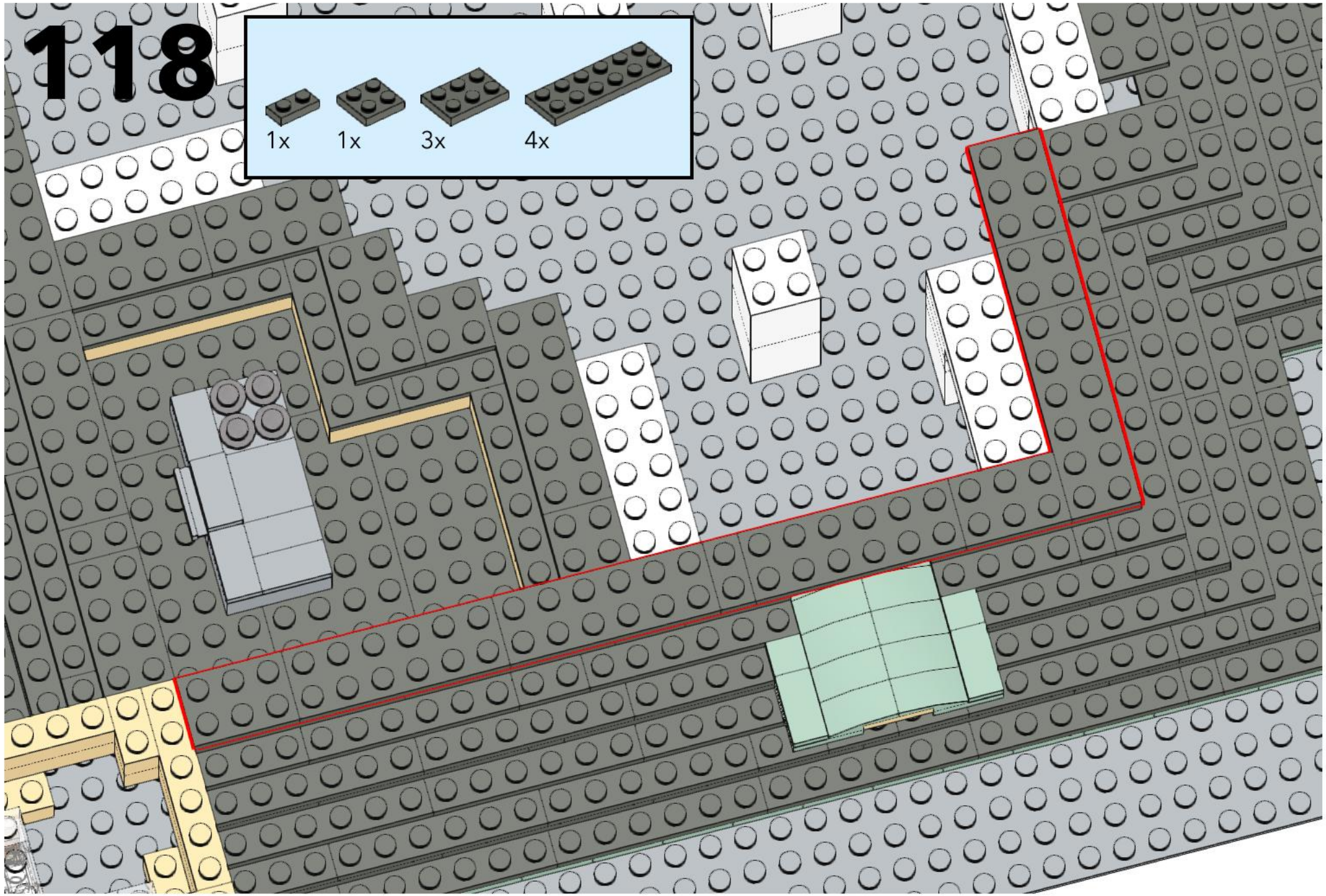
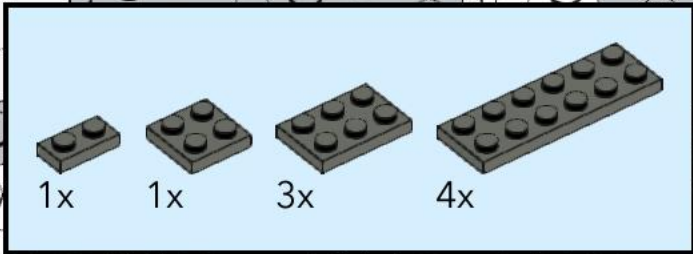

# 119

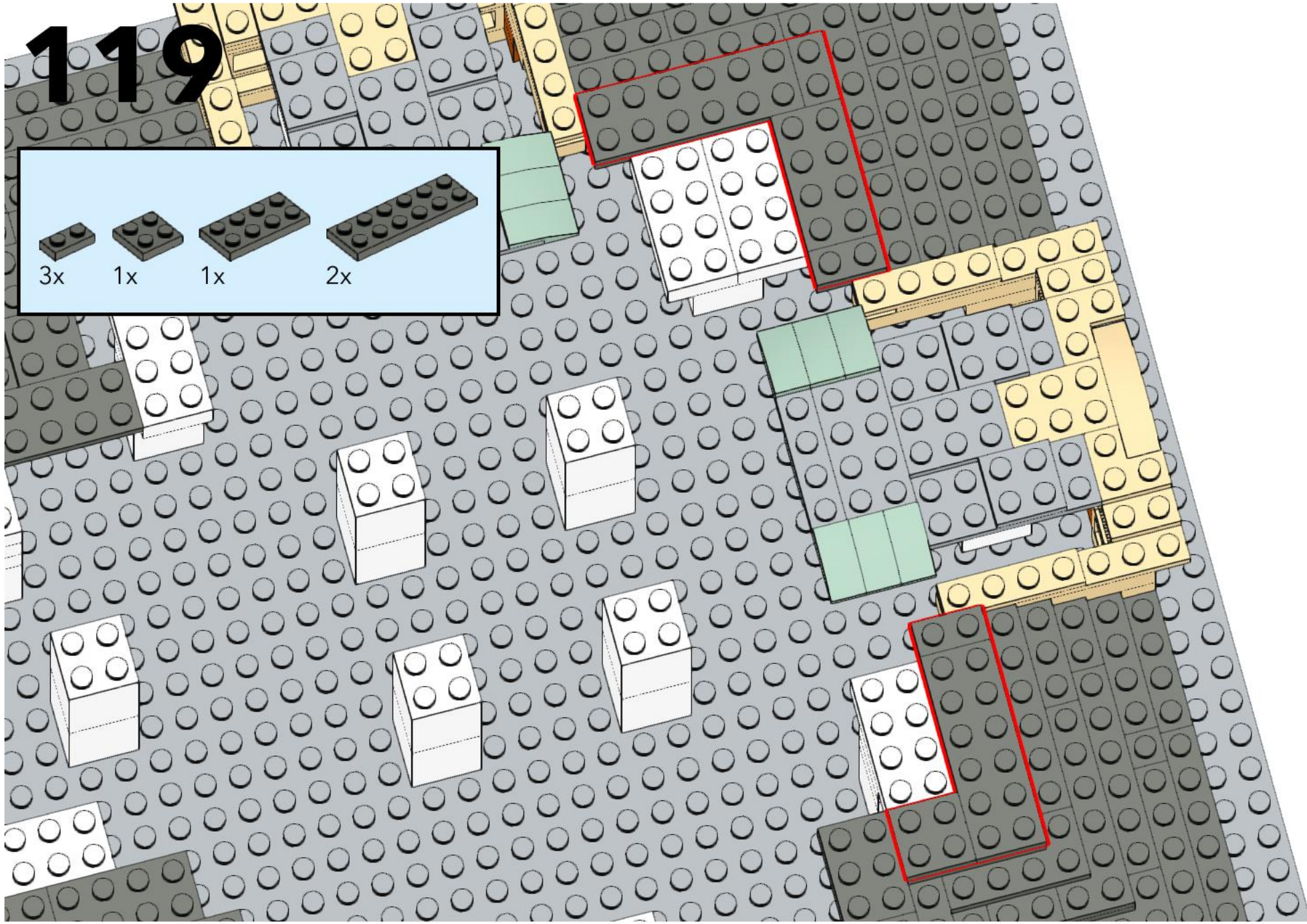
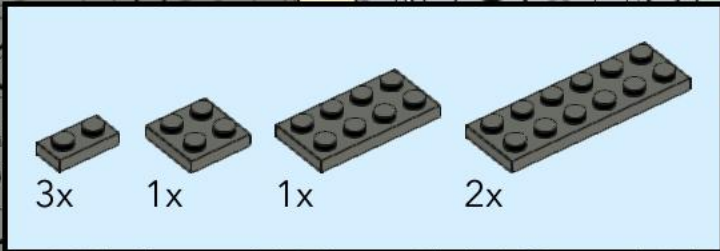



# 120

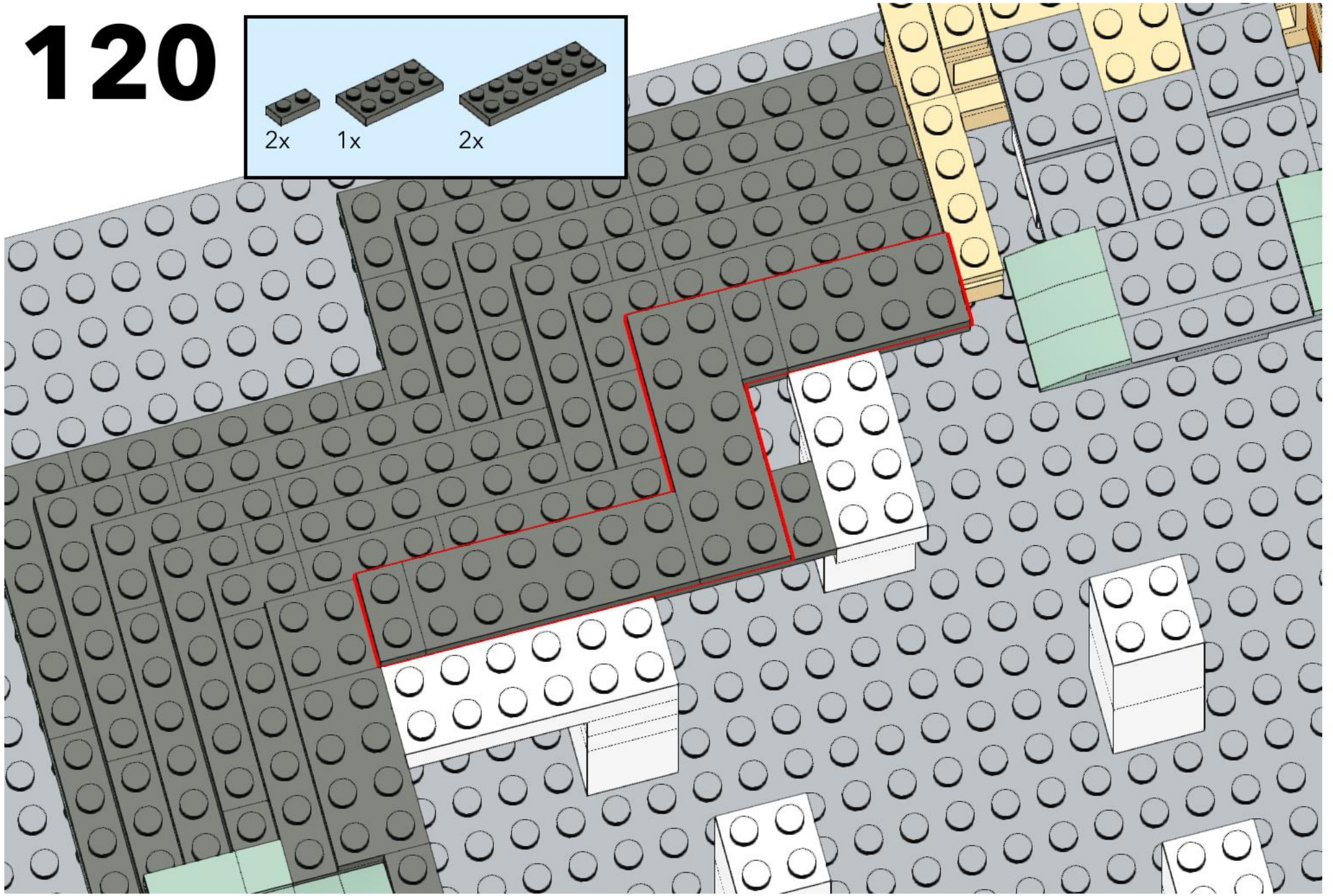
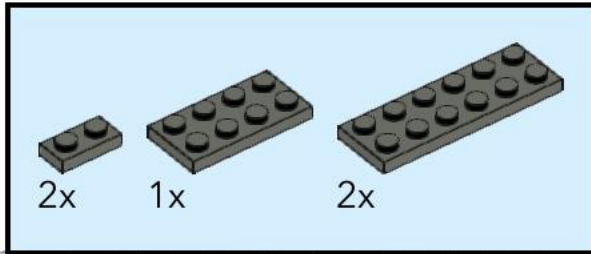

# 121

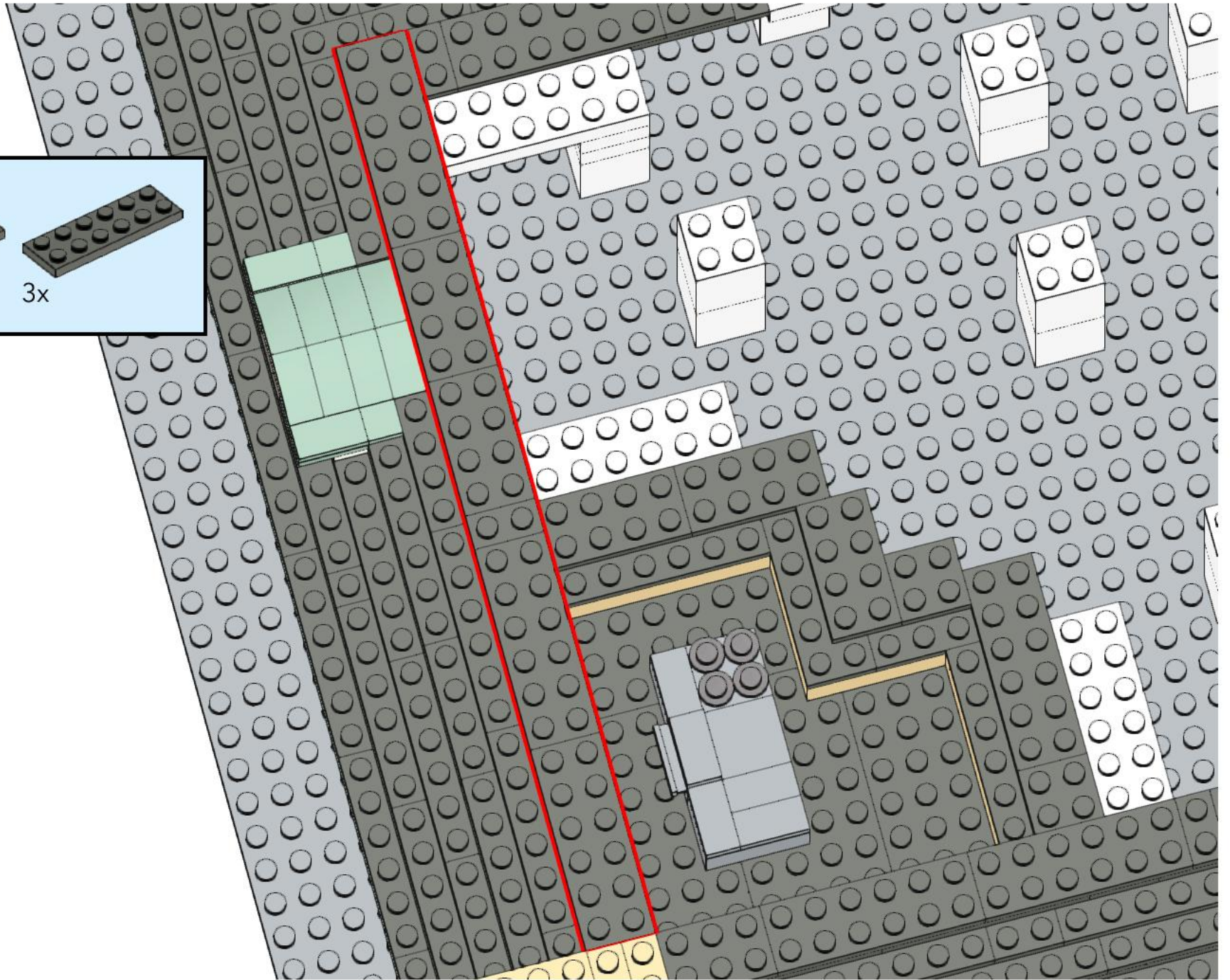
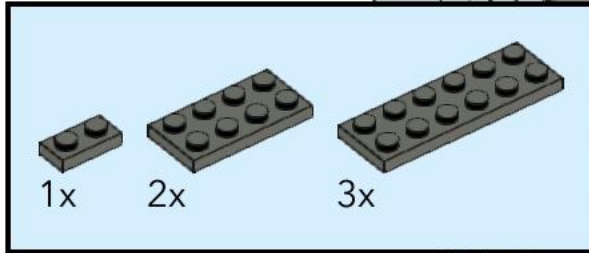

# 122

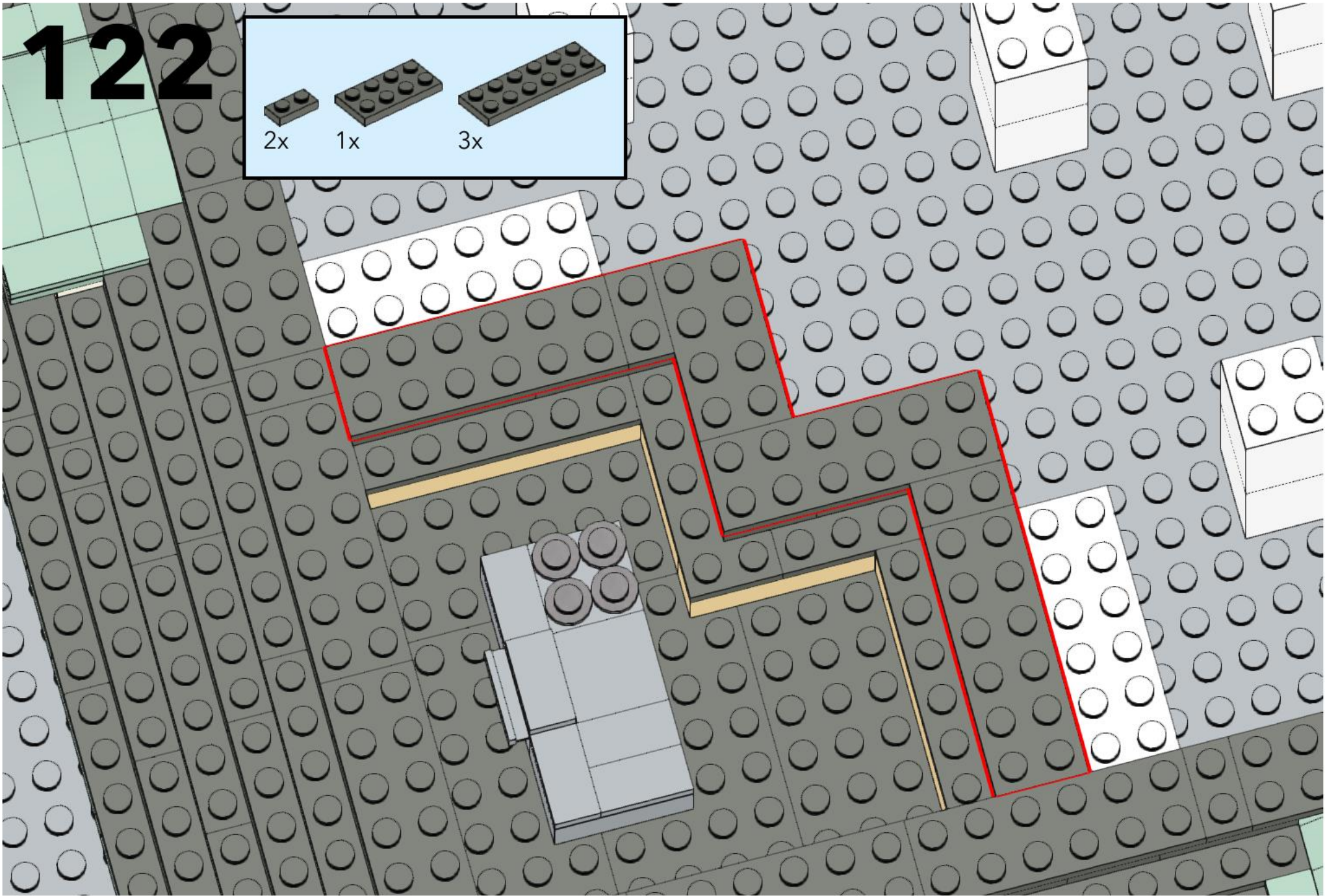
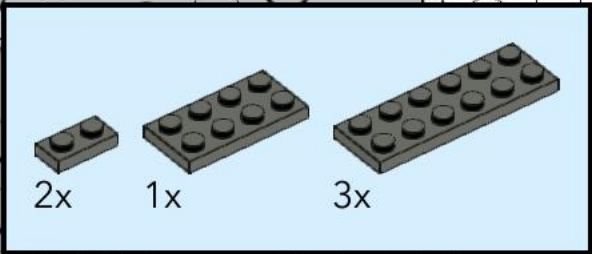

# 123

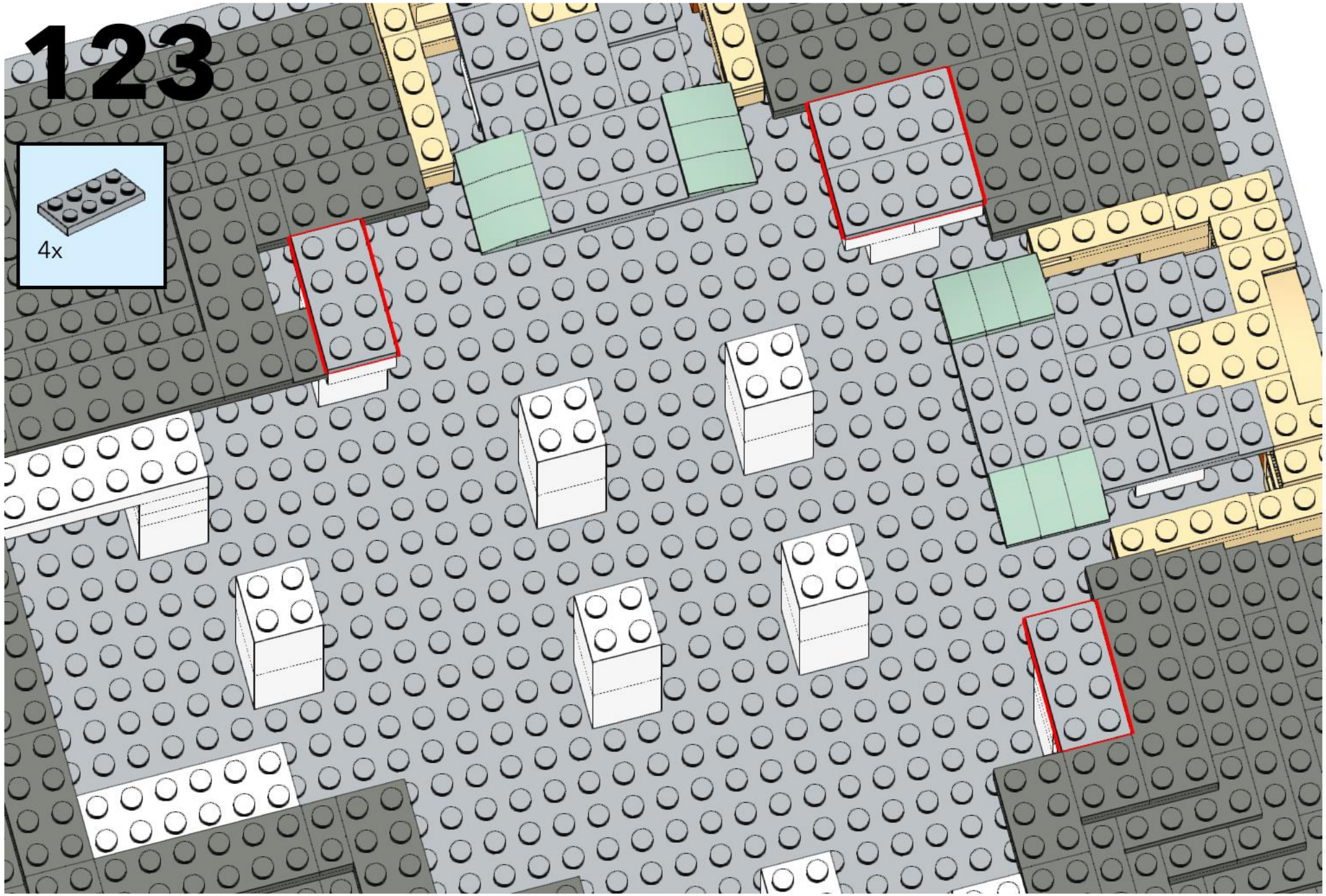
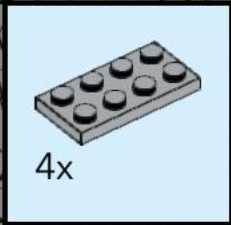

# 124

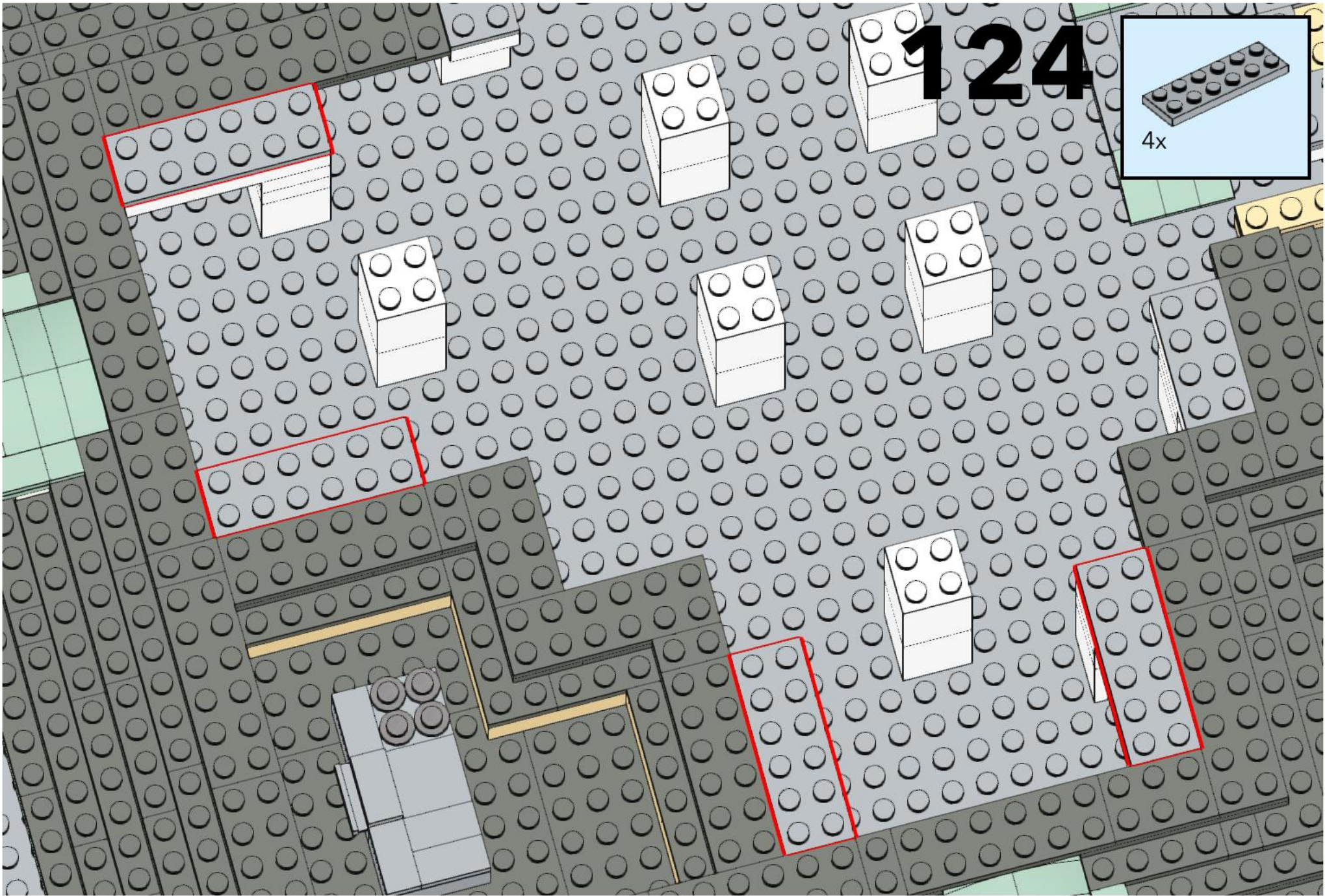
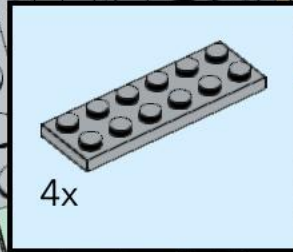

# 125

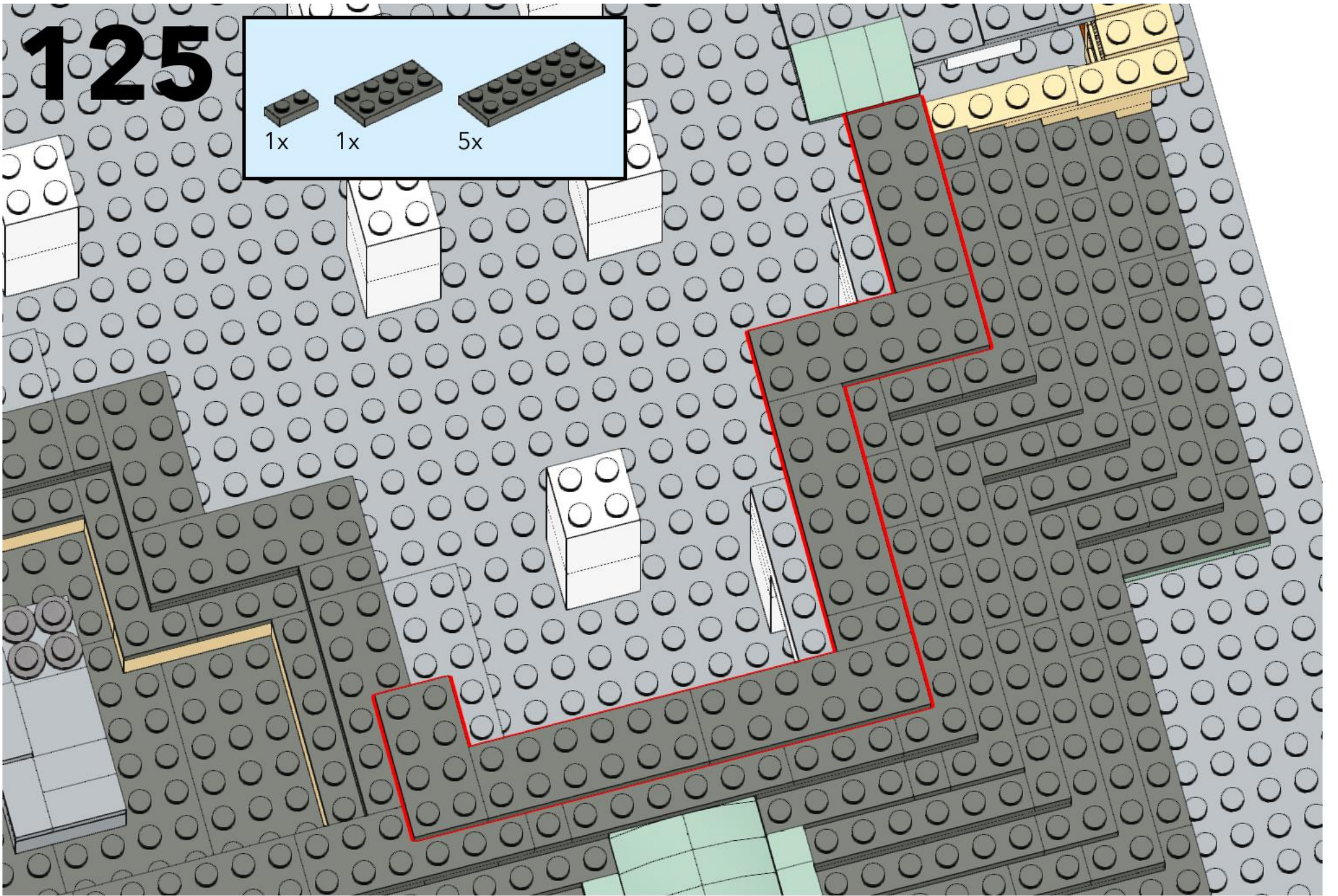
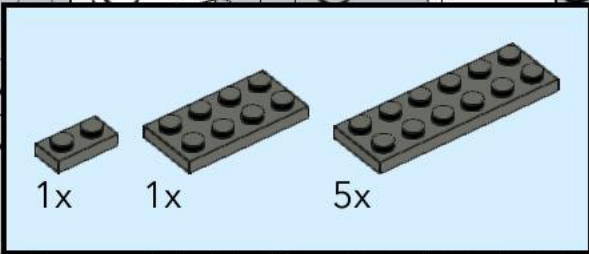

# 126

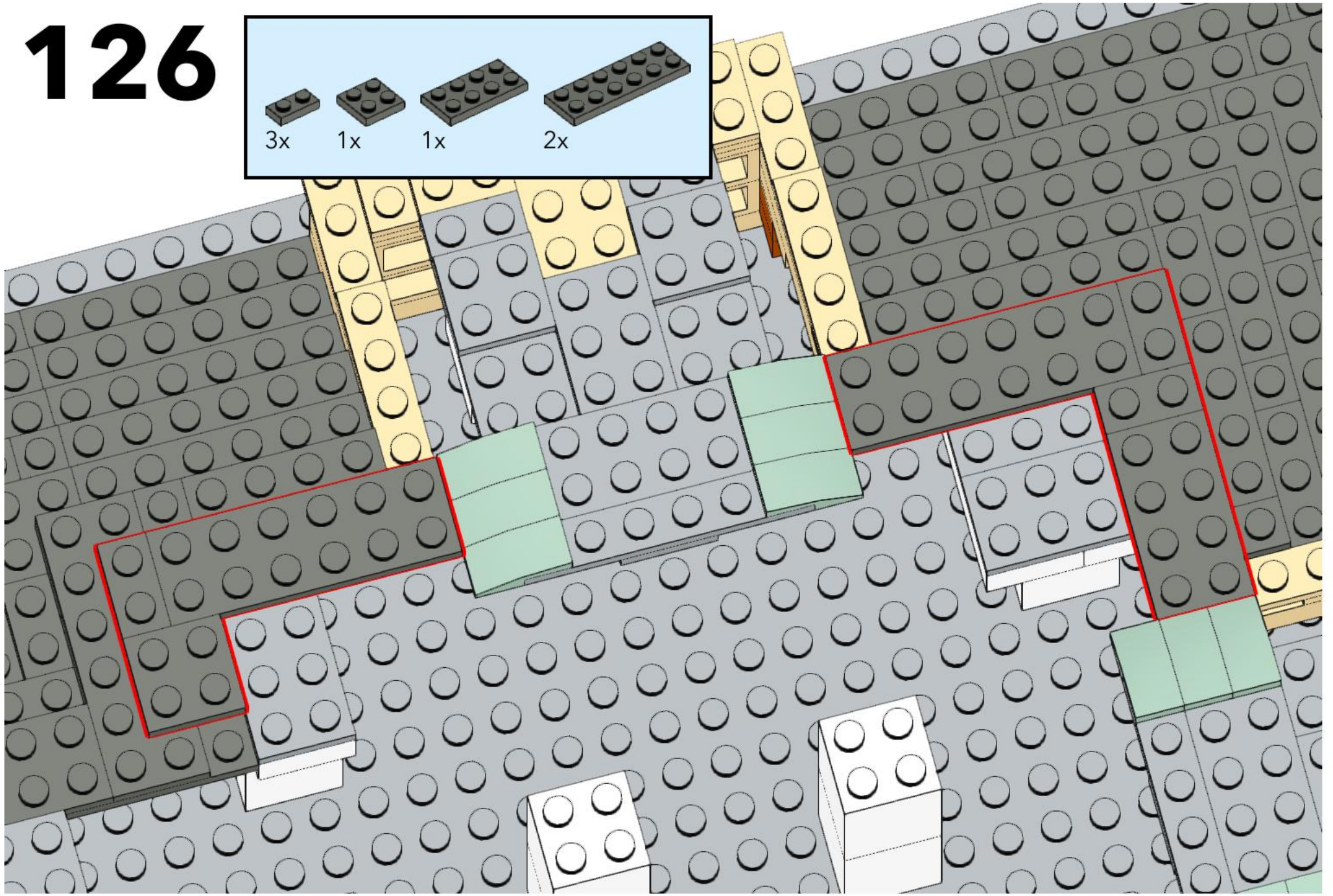
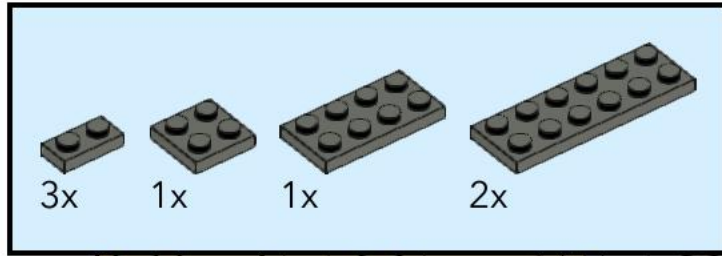

# 127

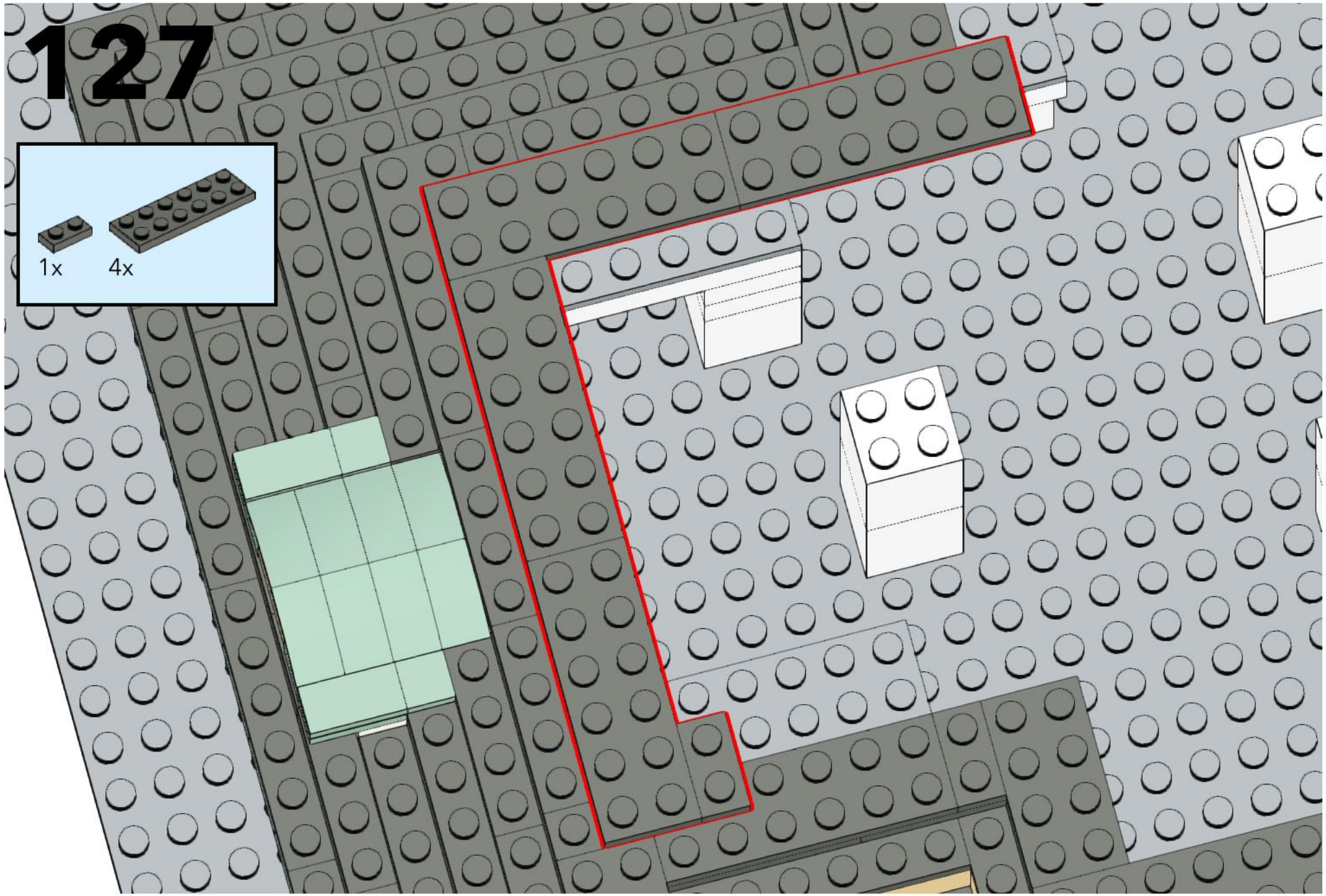
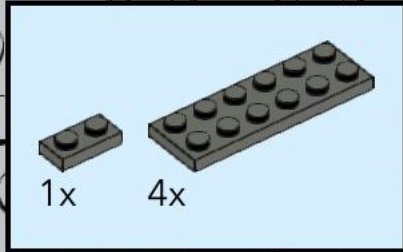



# 128

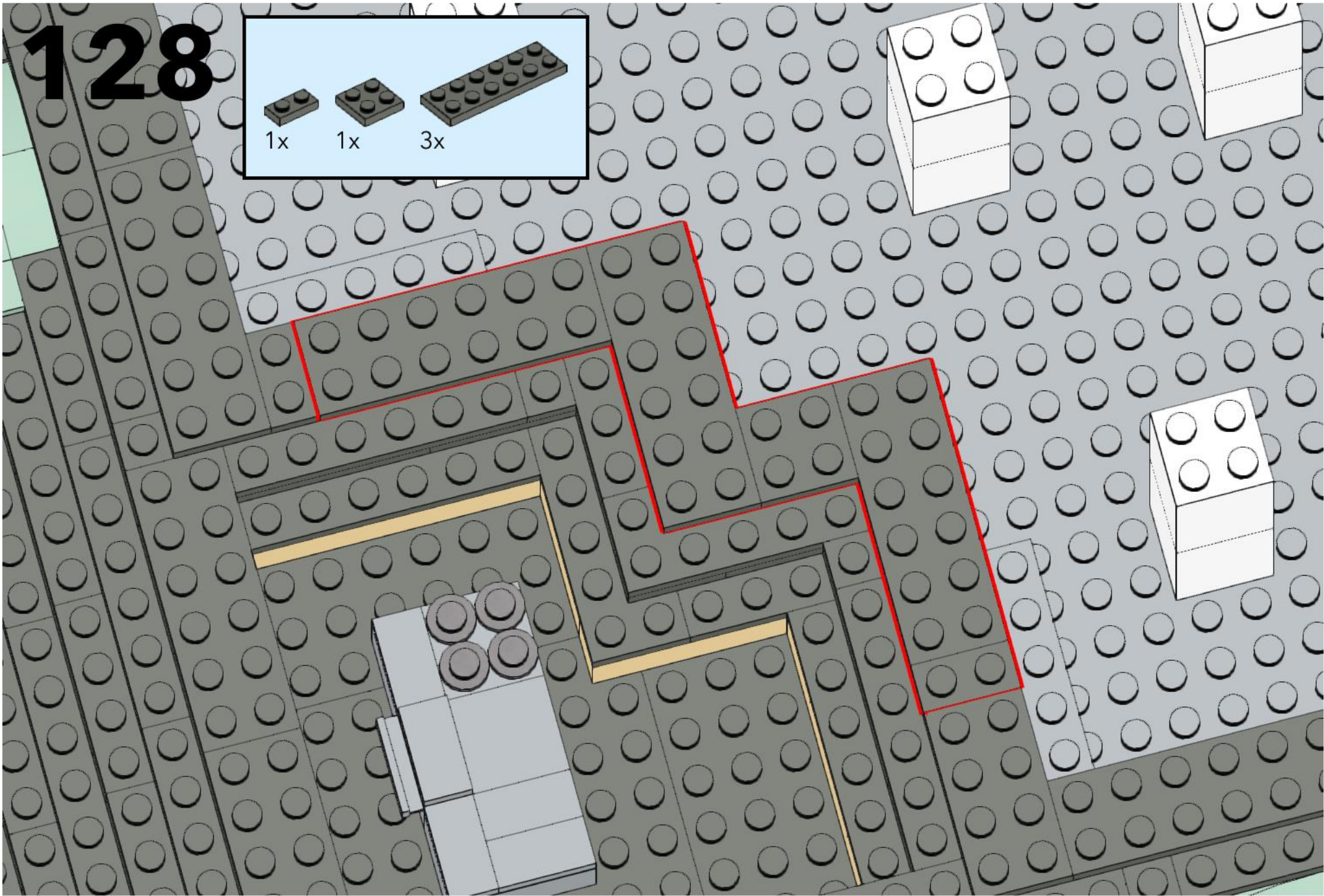
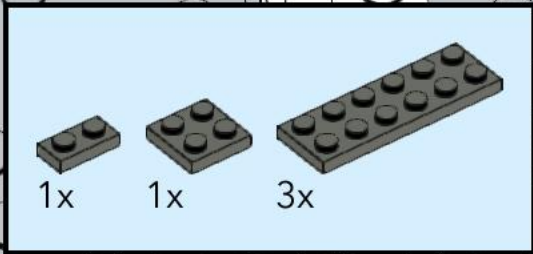

# 129

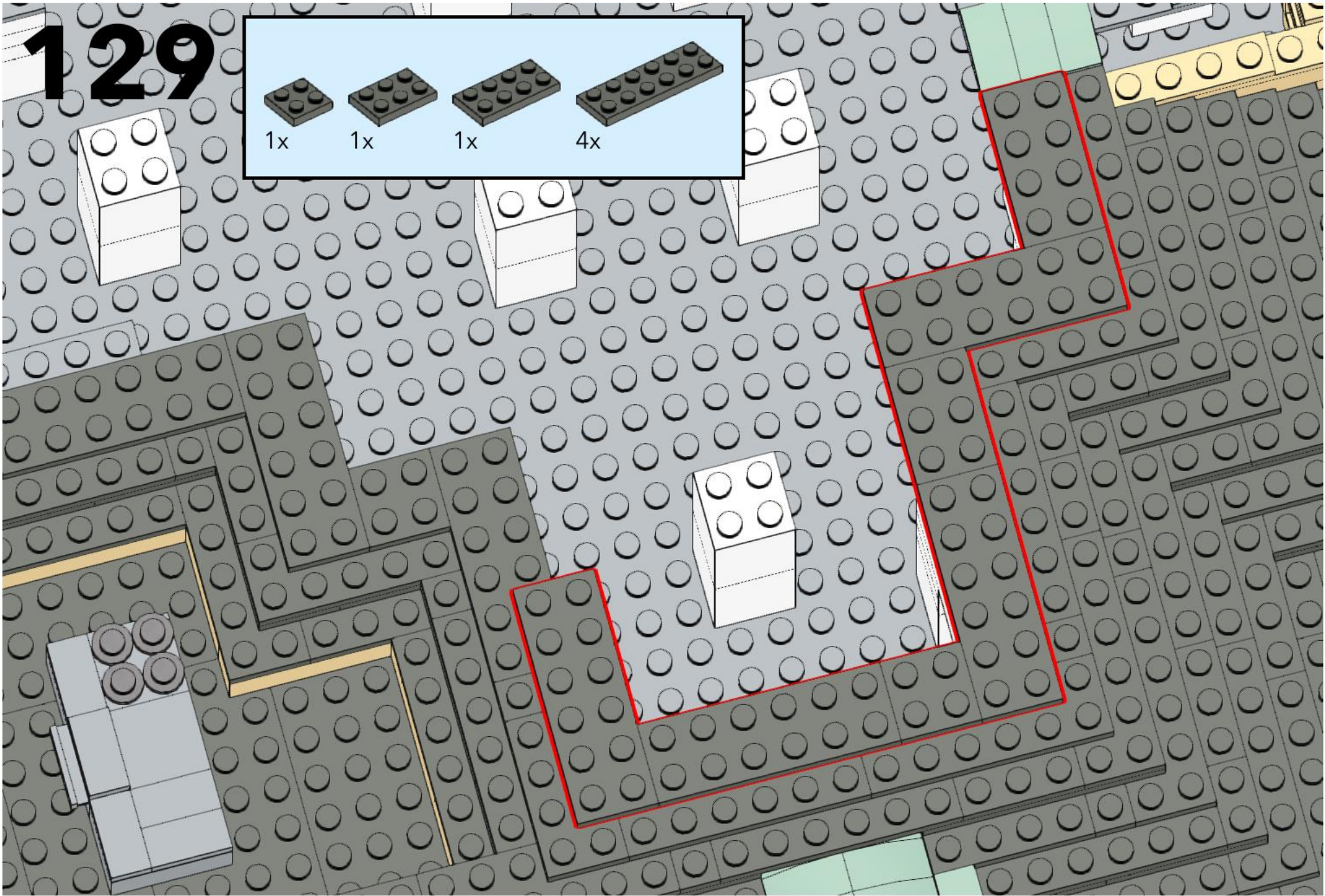
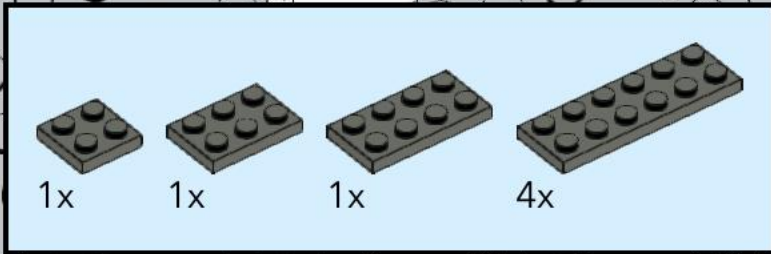

# 130

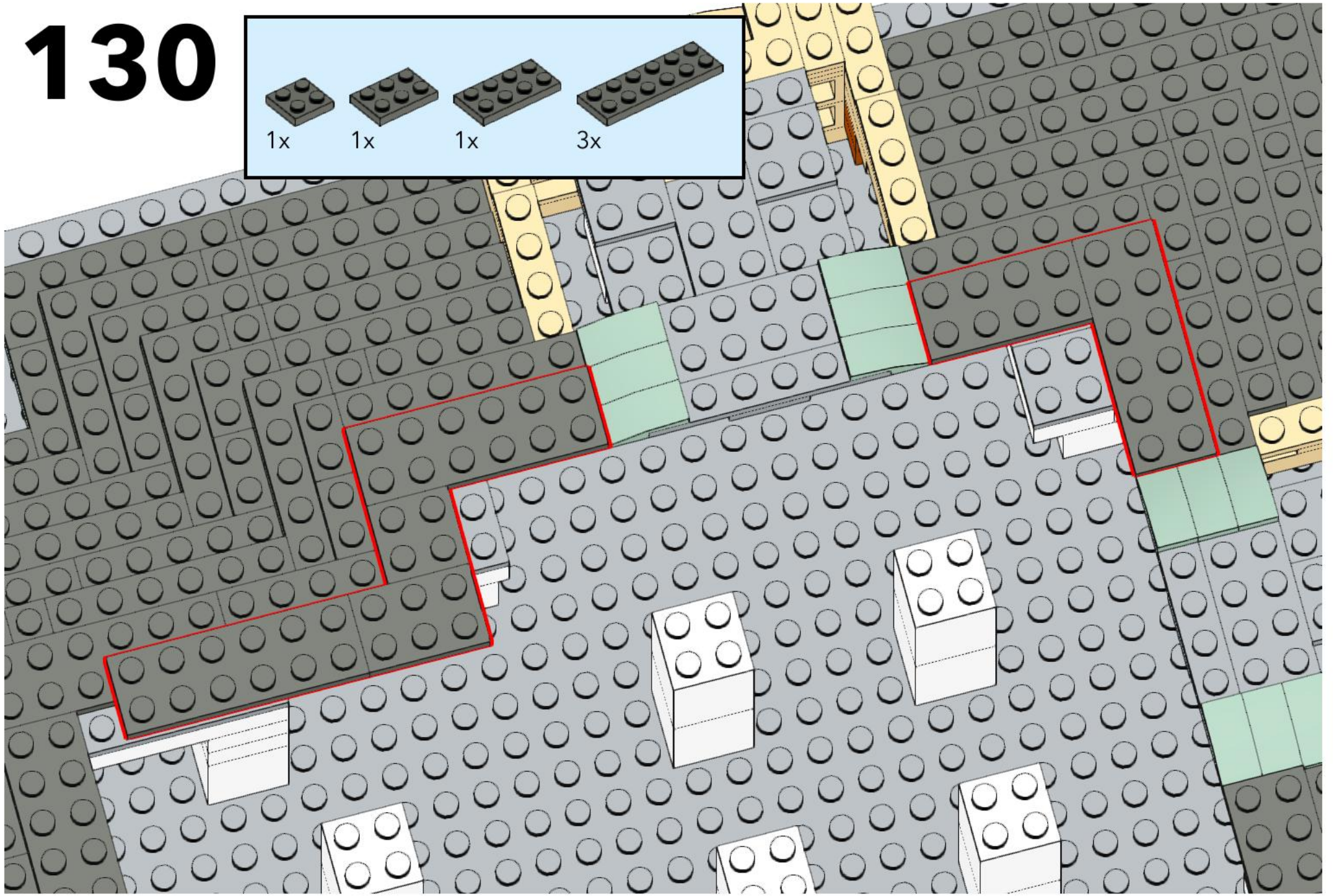
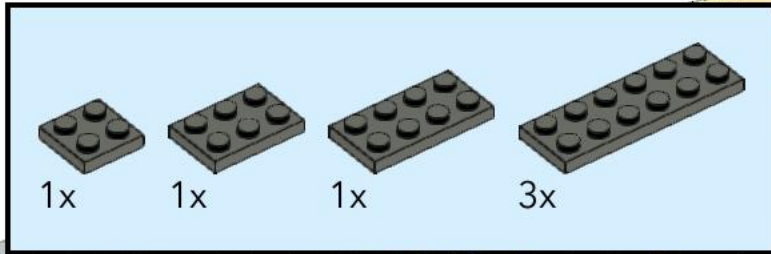

# 131

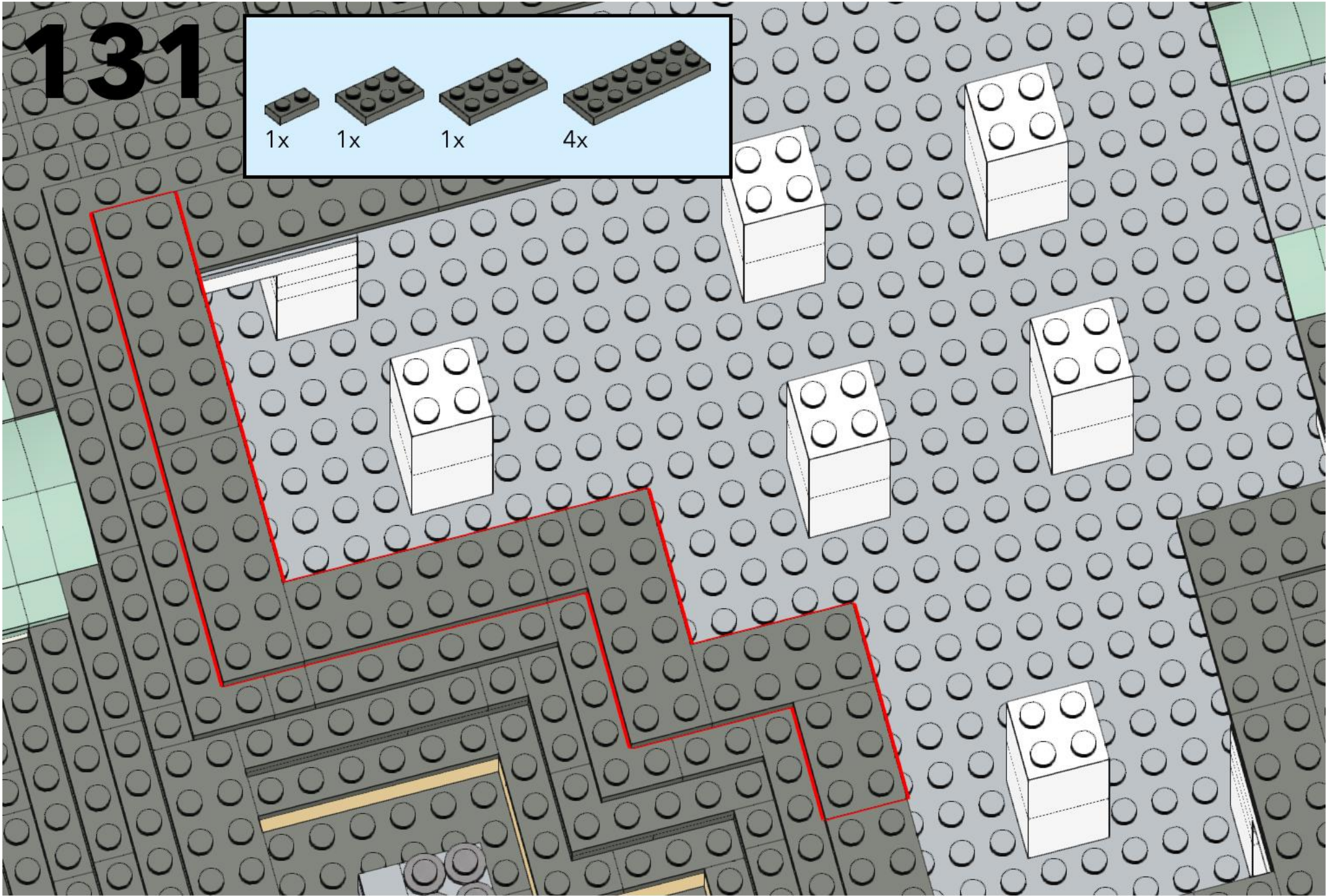
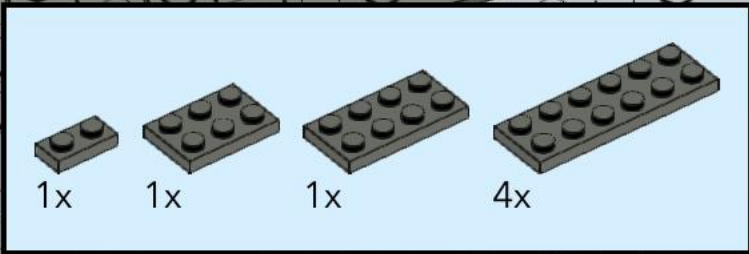

# 132

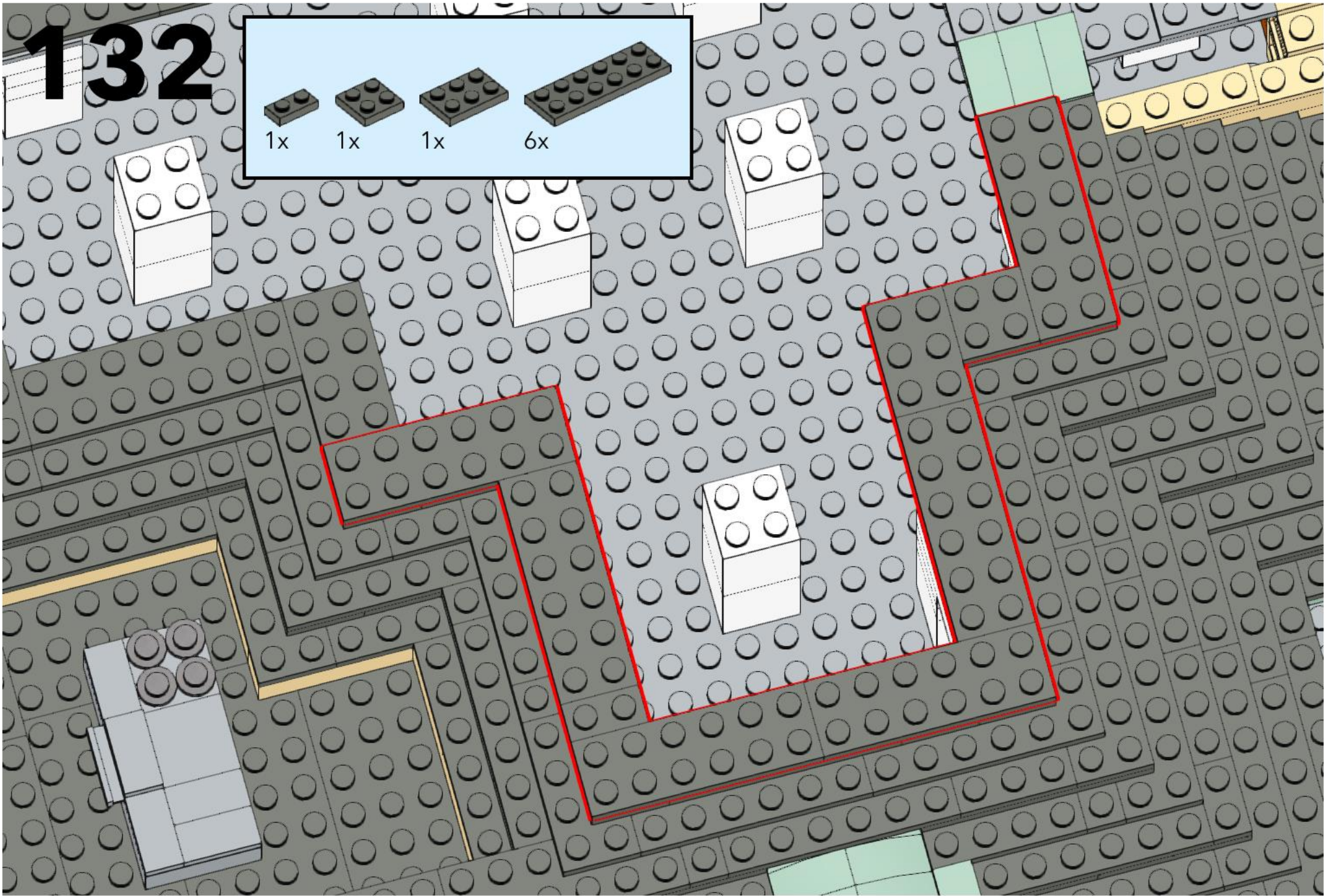
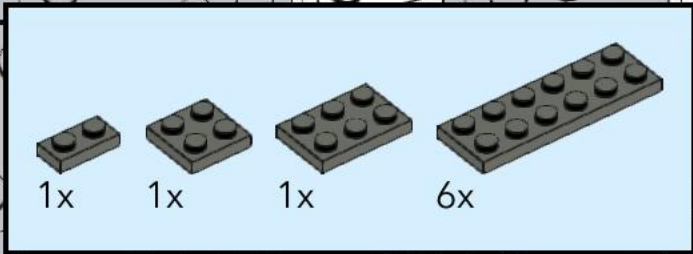

# 133

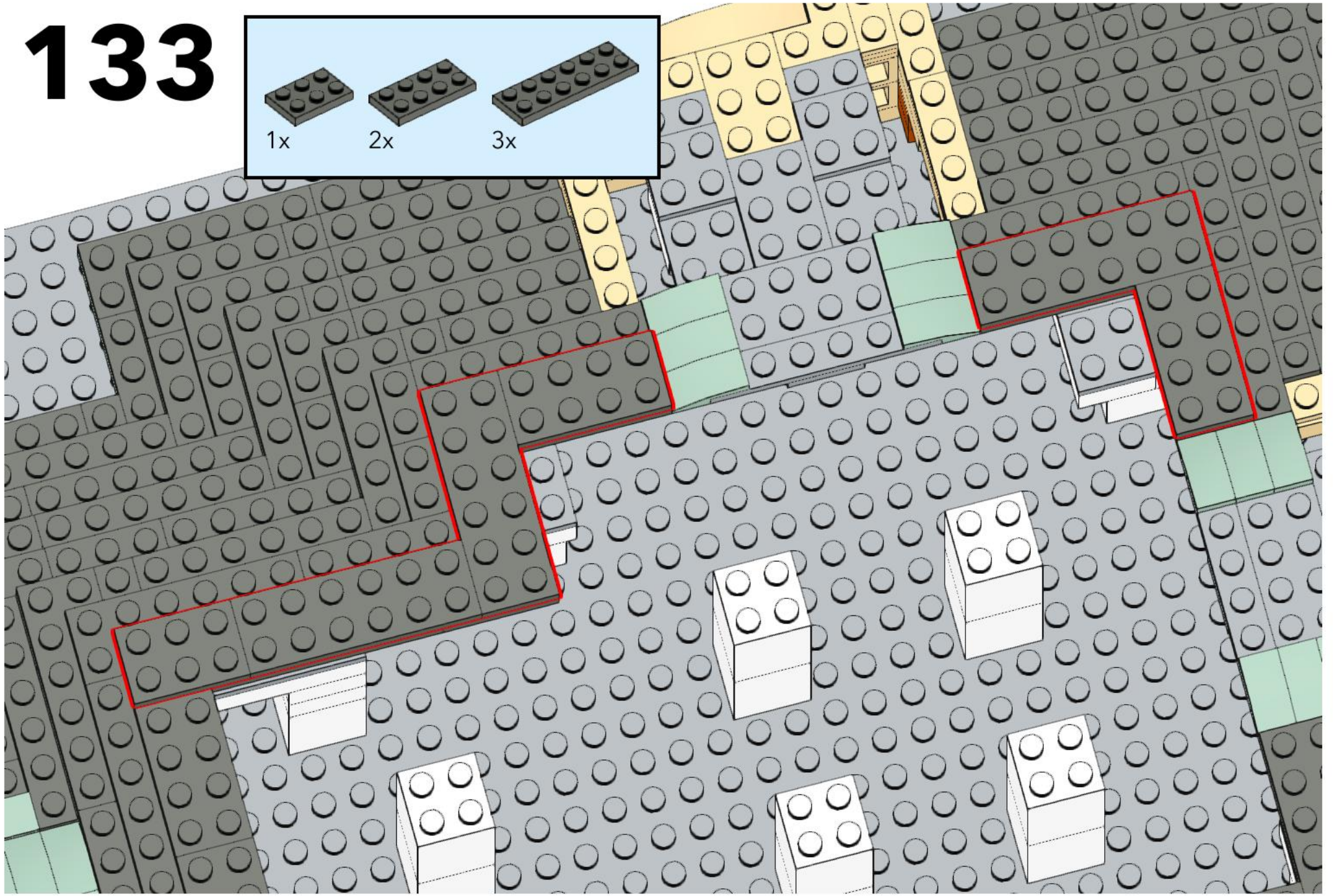
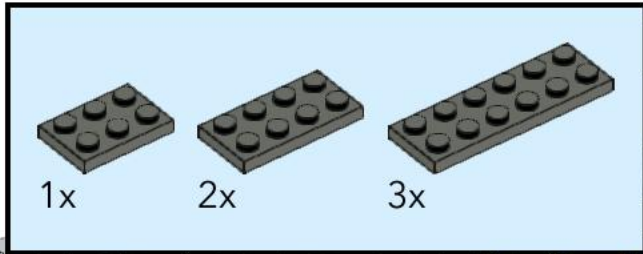

# 134

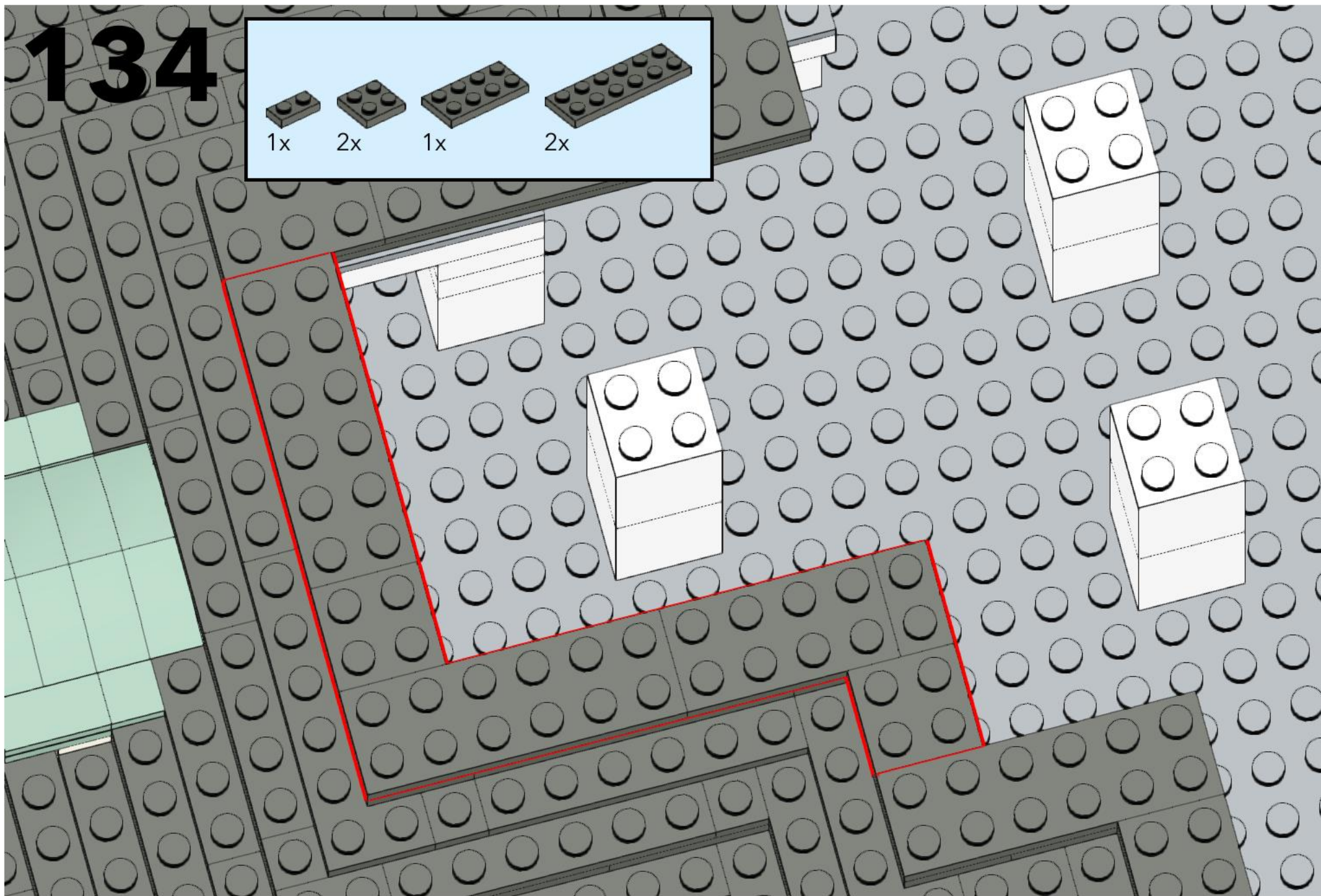
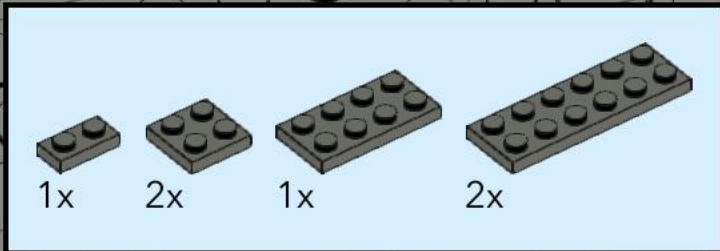

# 135

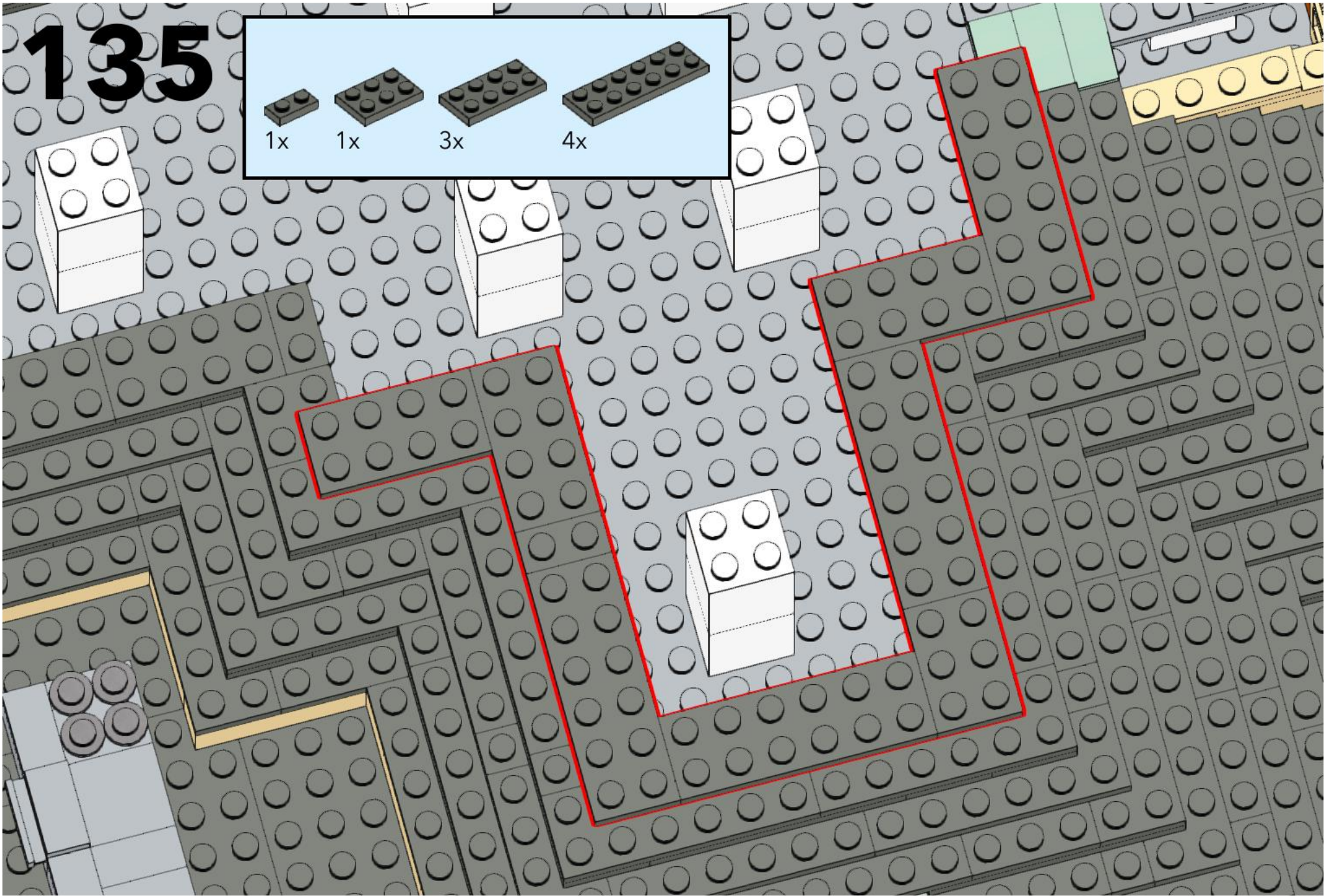
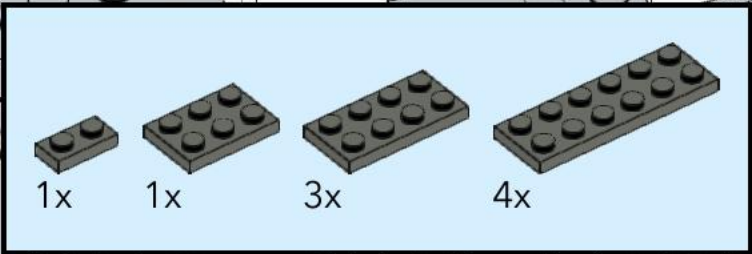



# 136

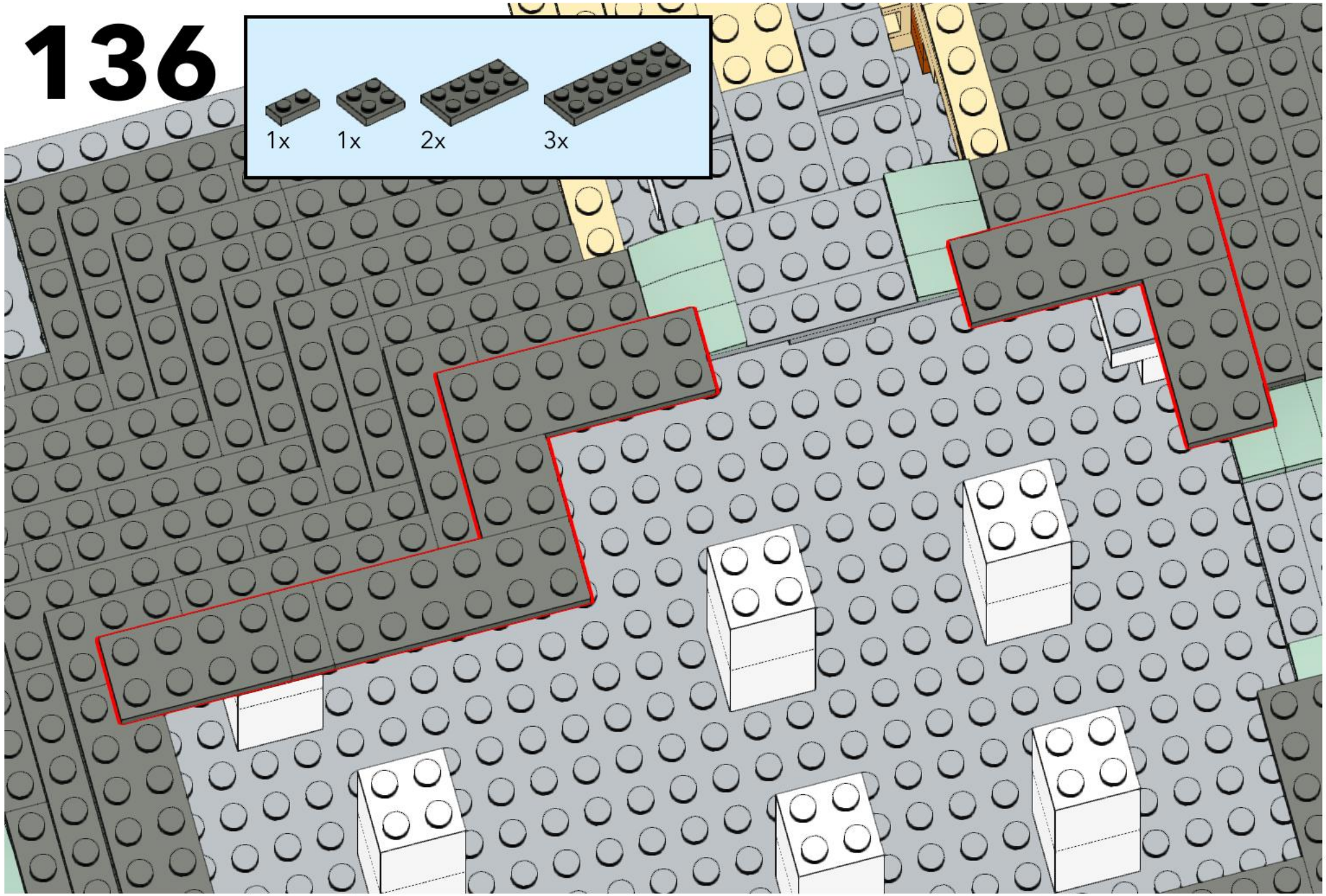
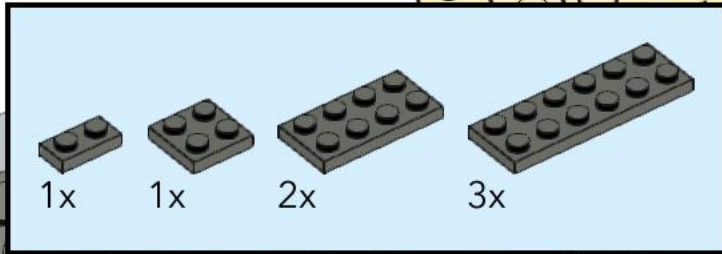

# 137

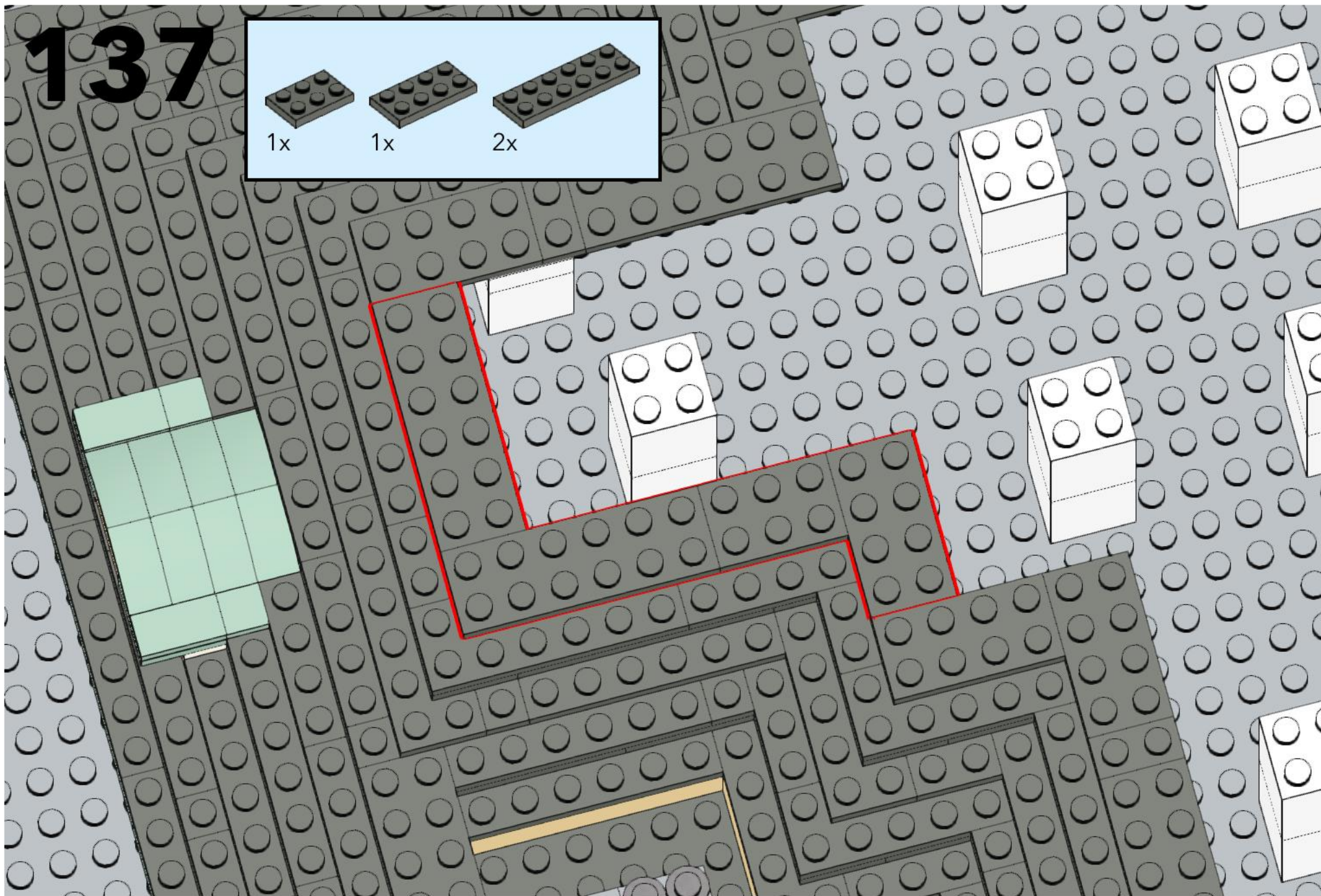
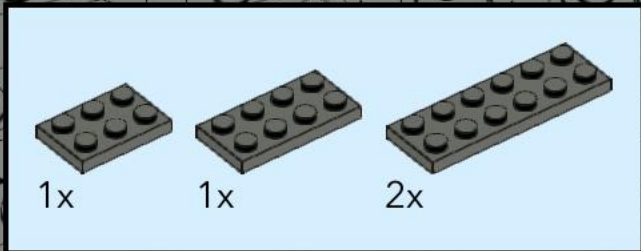

# 138

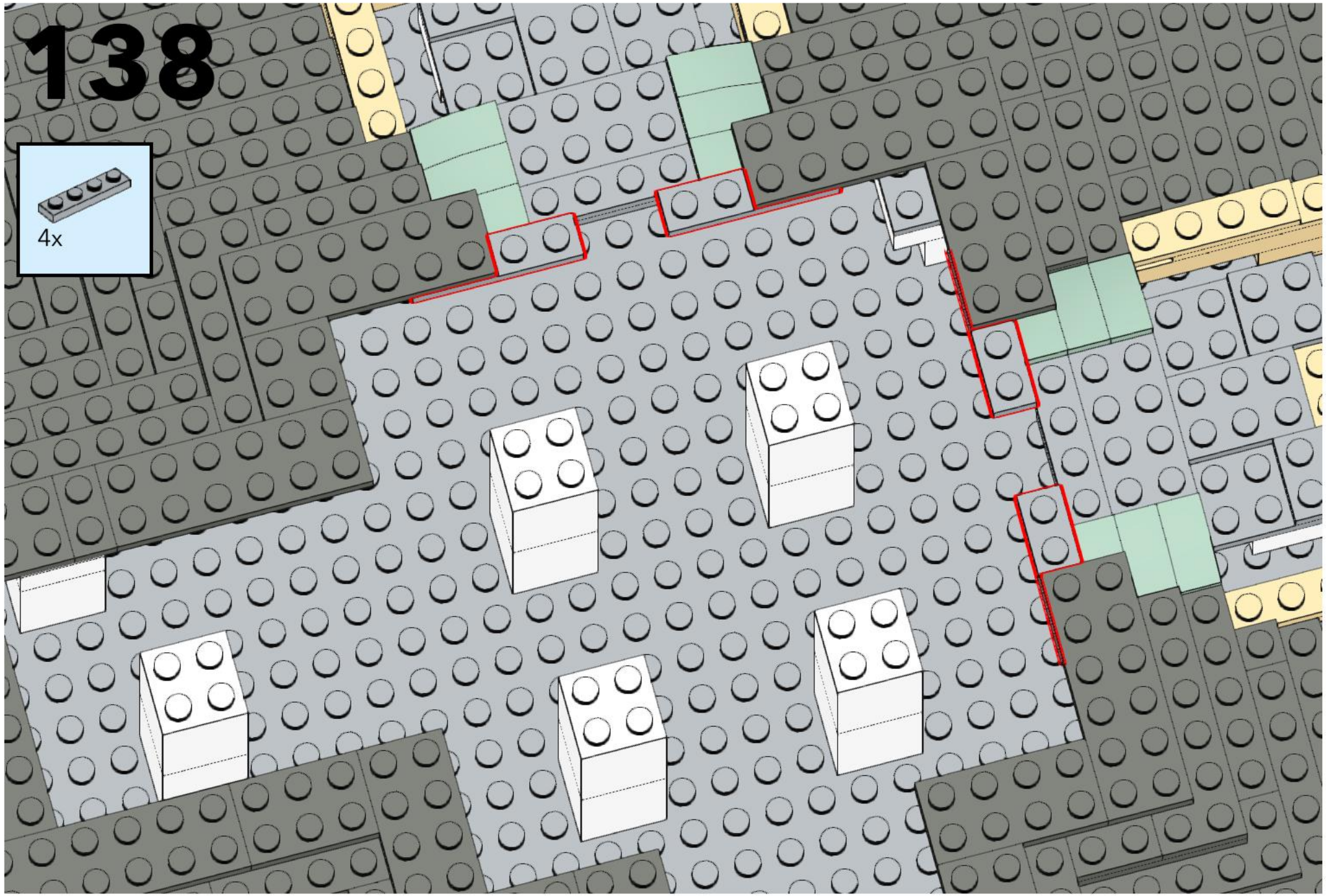
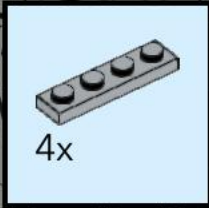

139

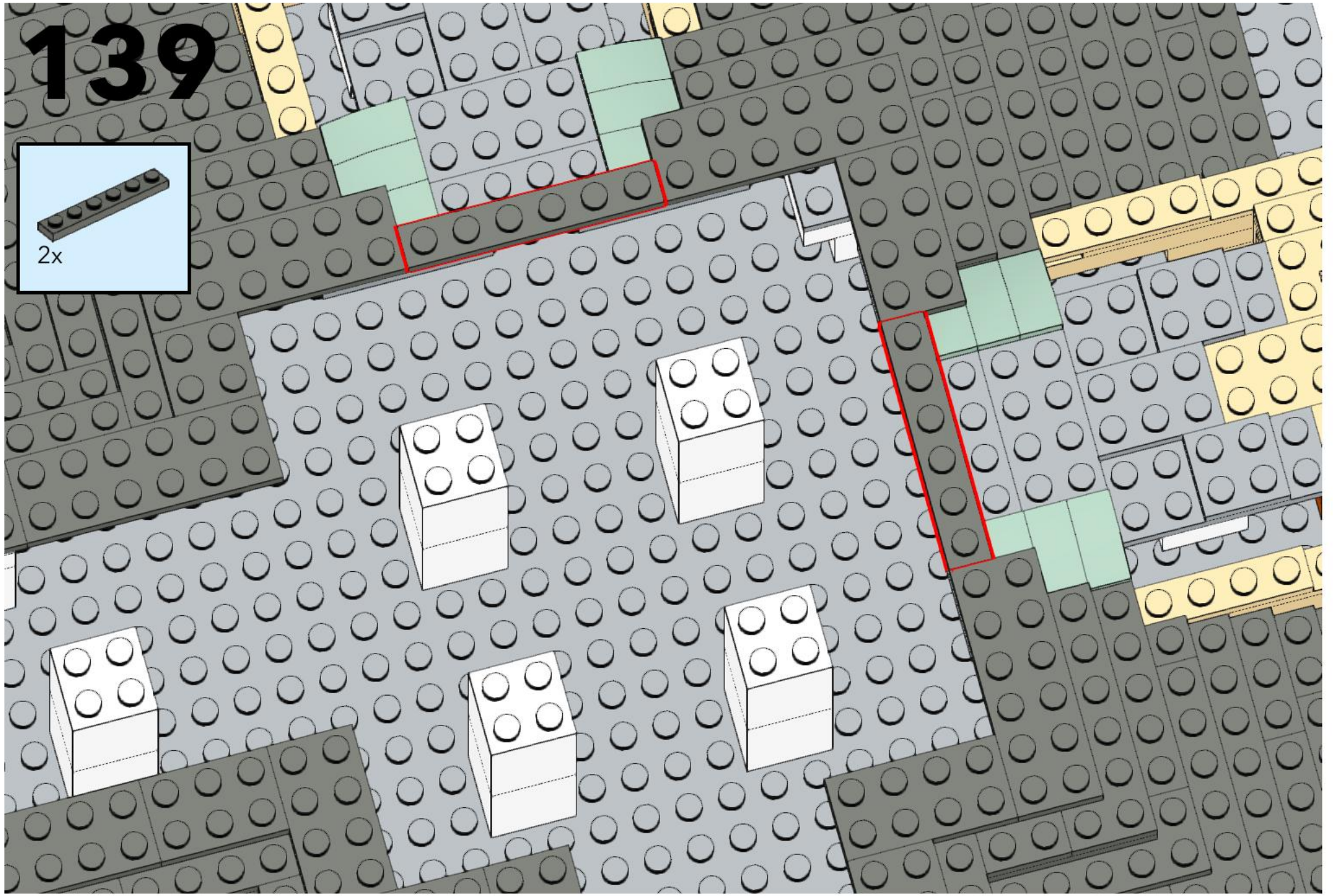
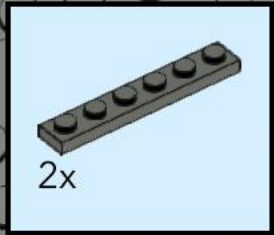

# 140

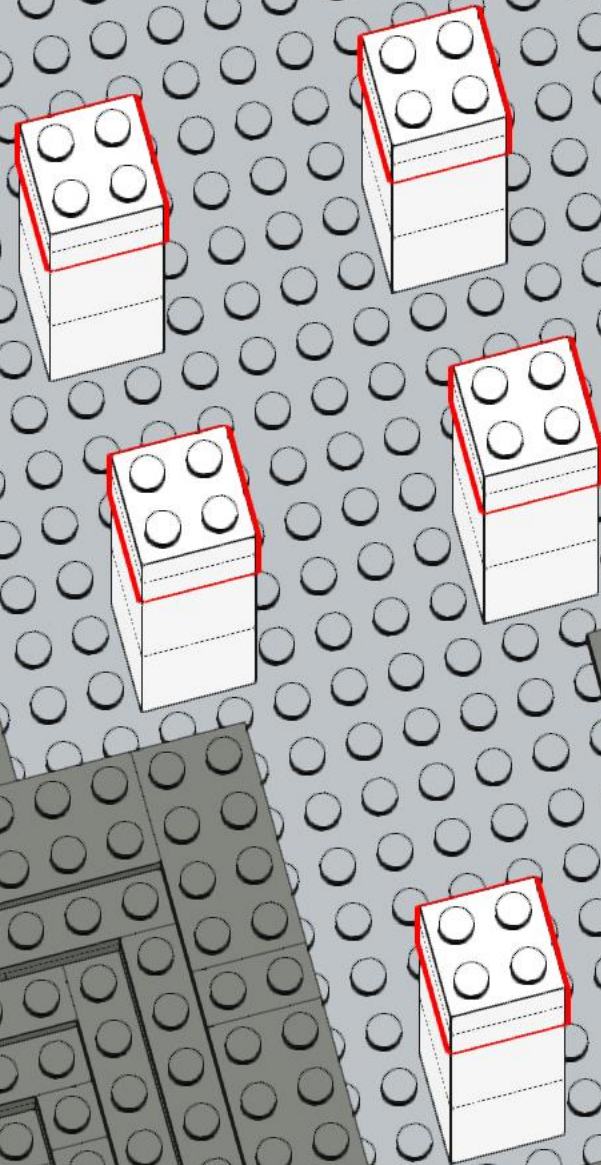
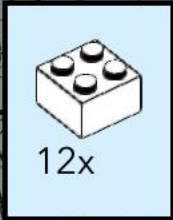

# 141

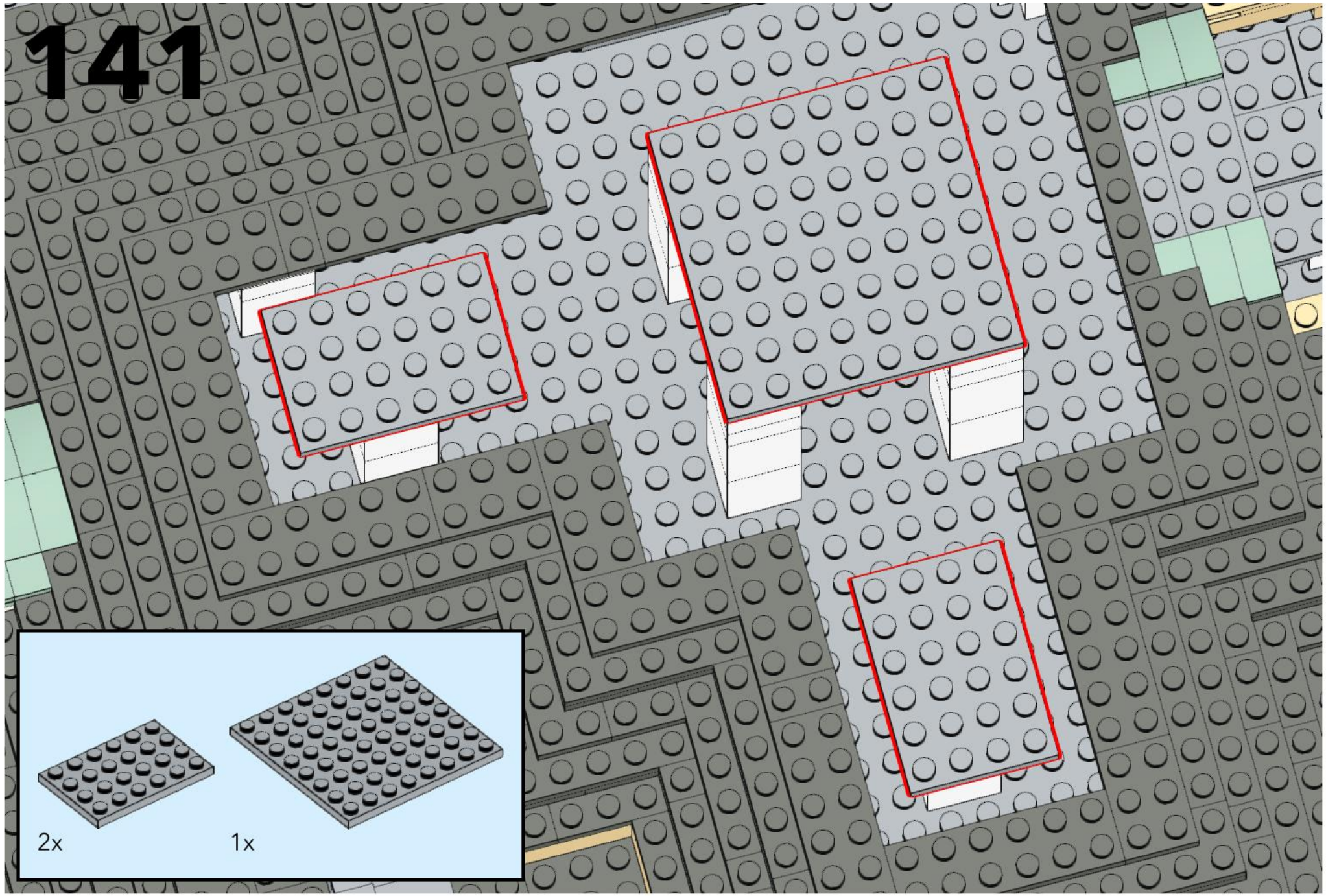

2x

1x

# 142

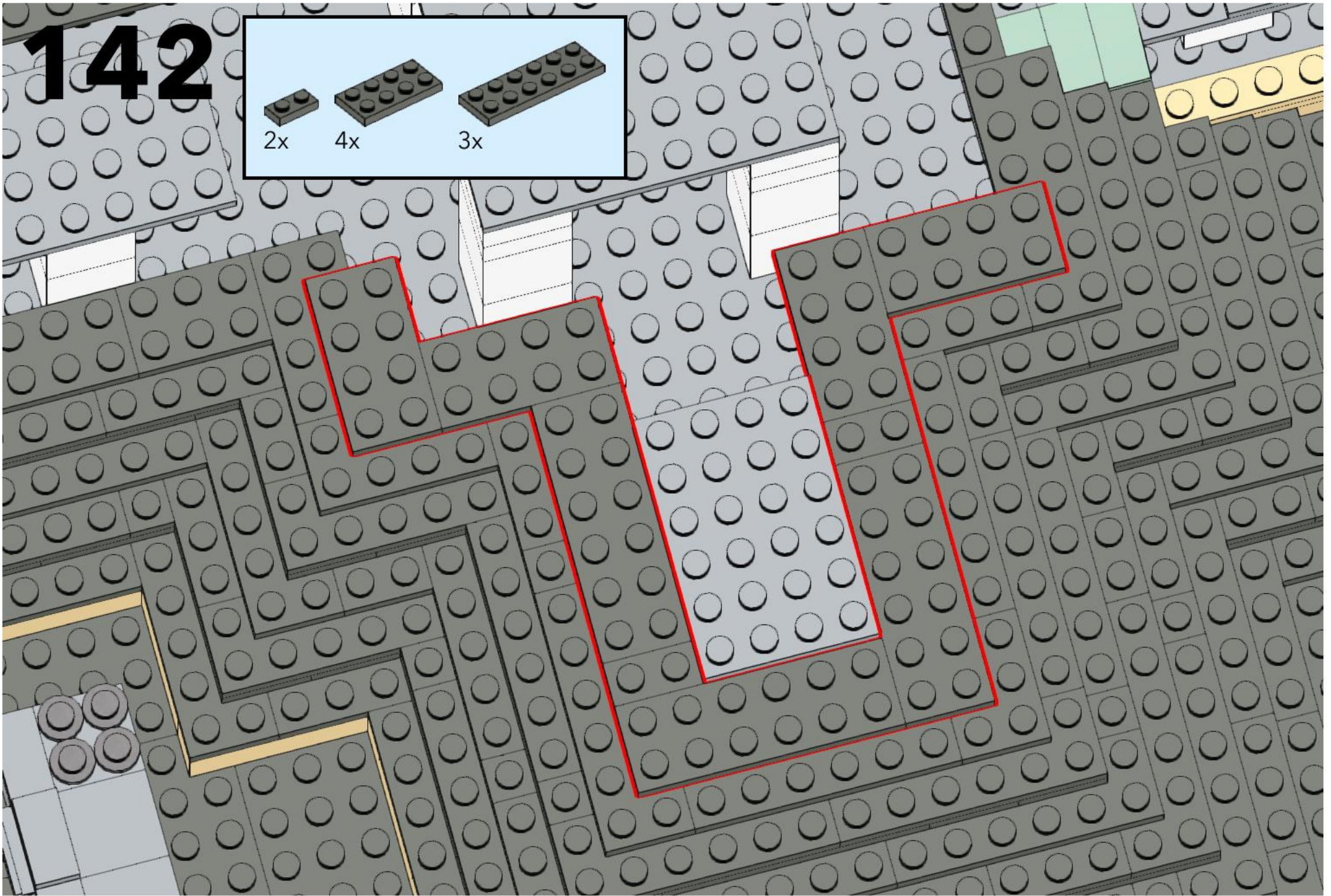
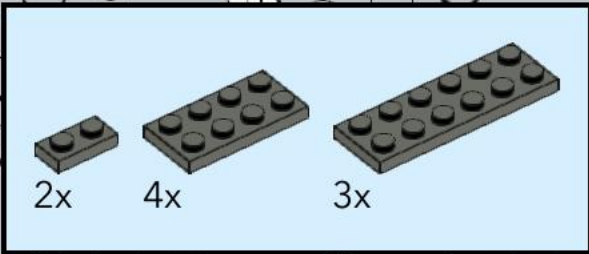

# 143

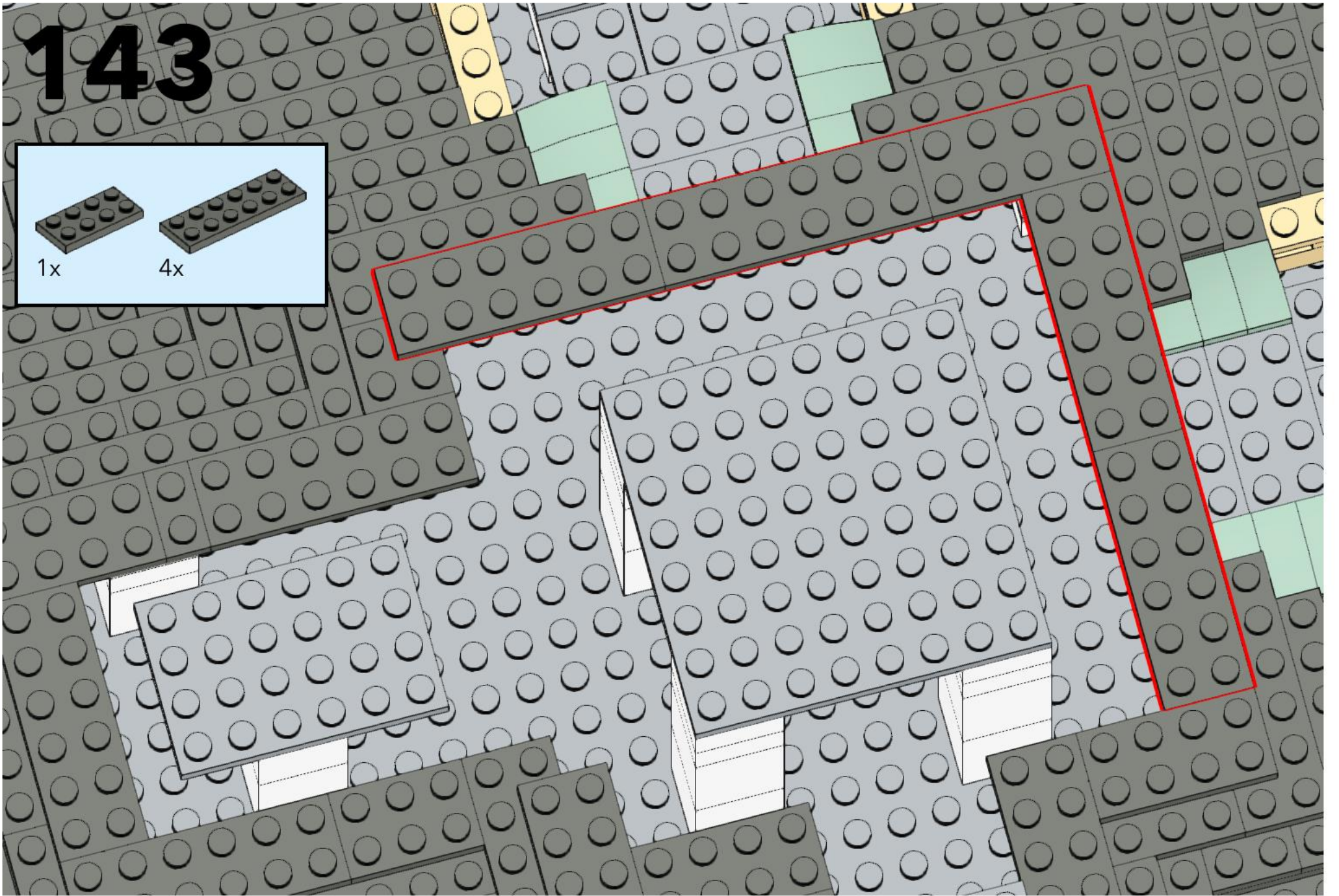
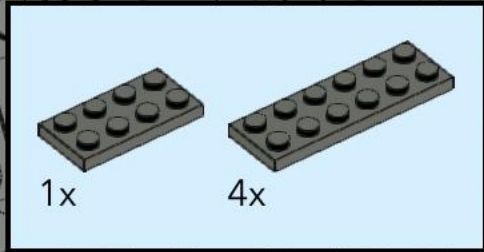



# 144

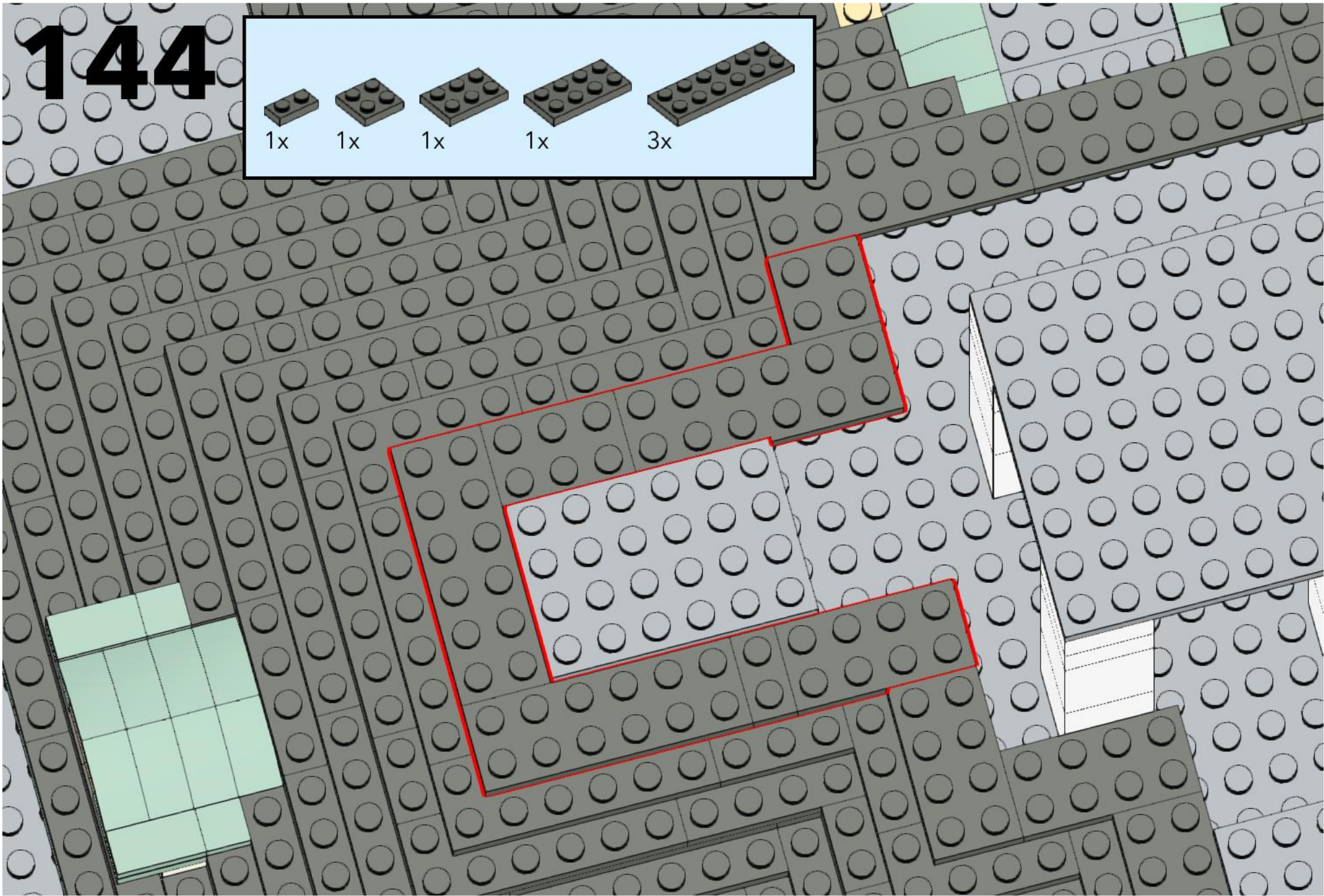
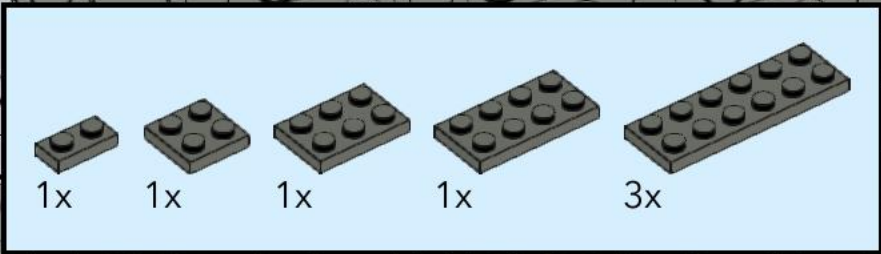

# 145

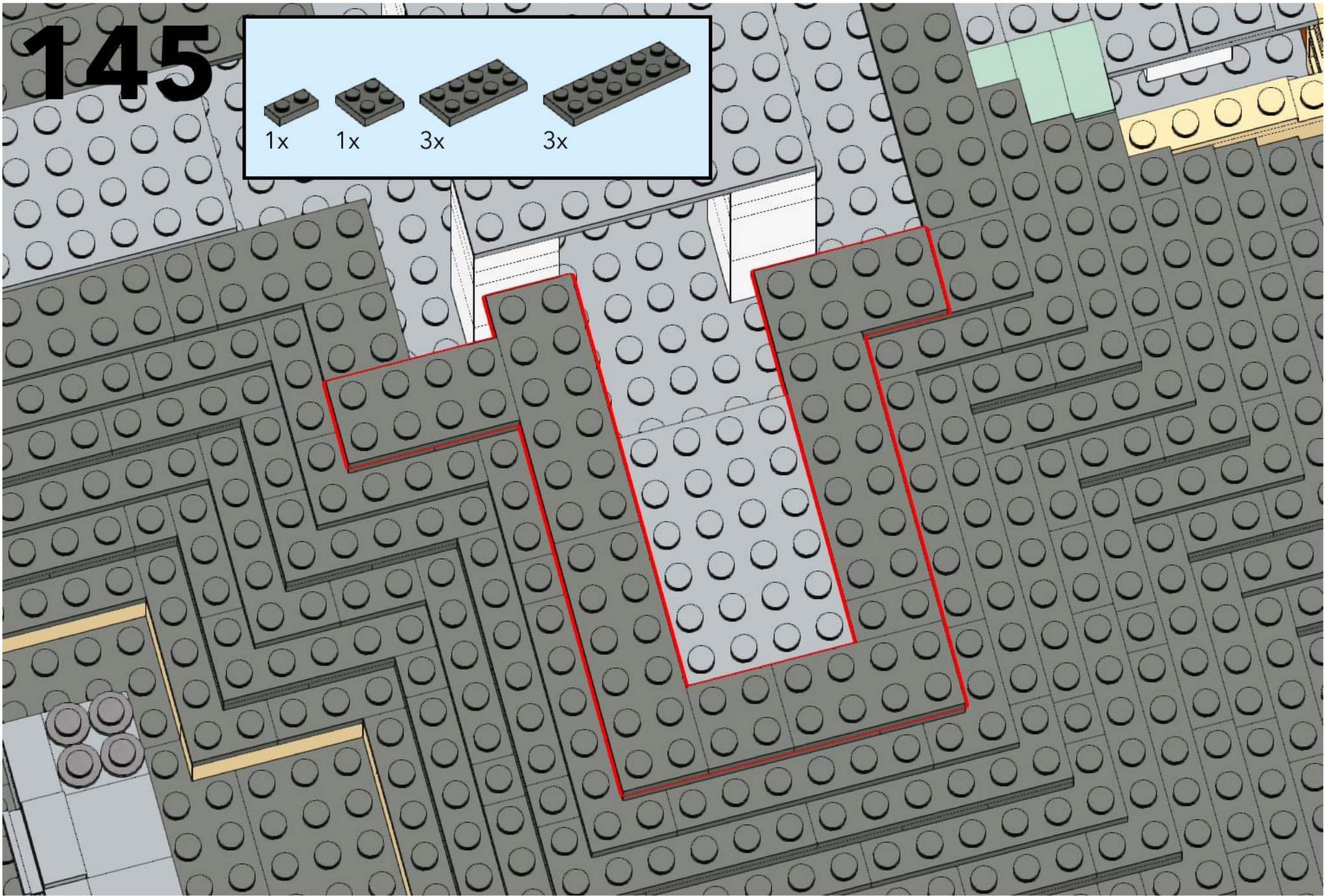
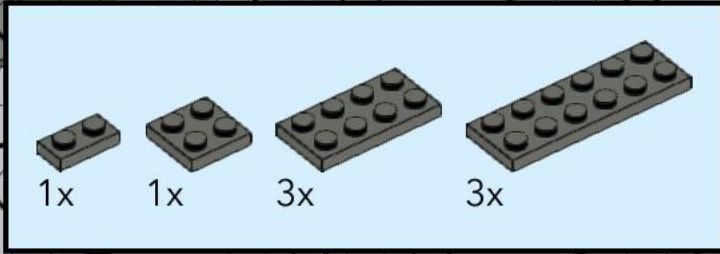

# 146

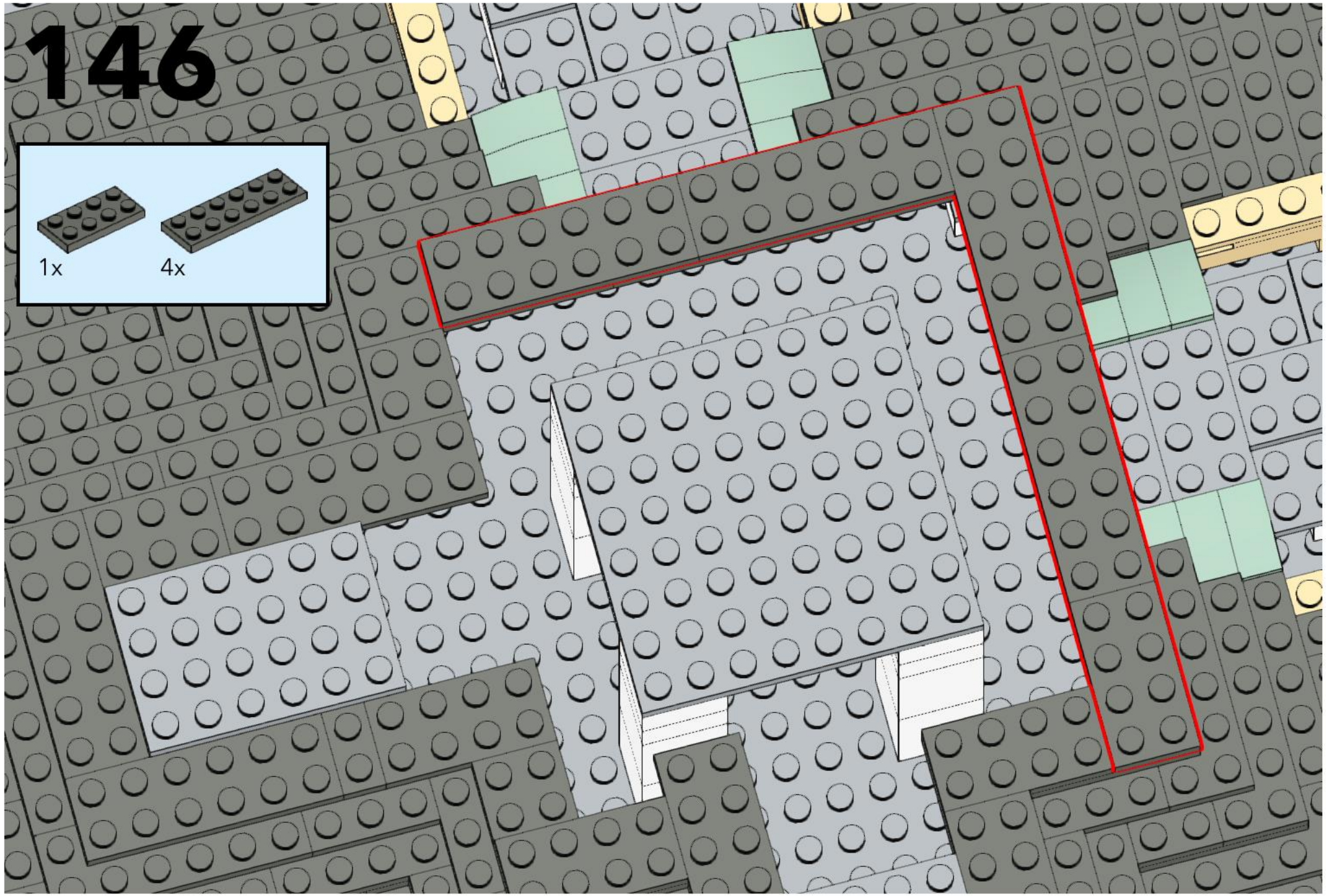
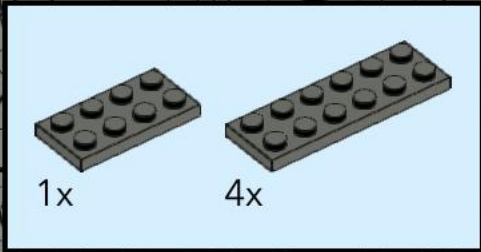

# 147

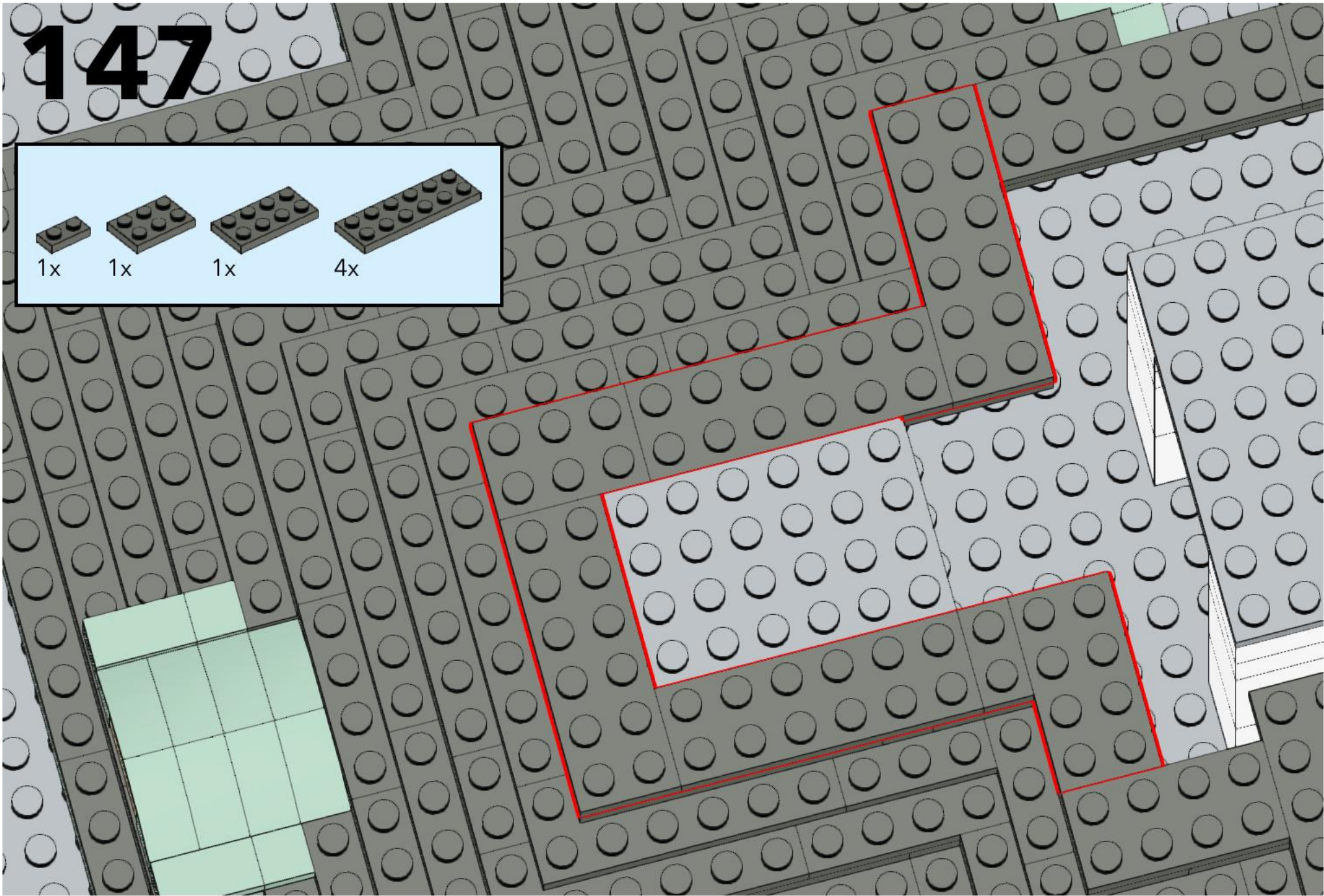
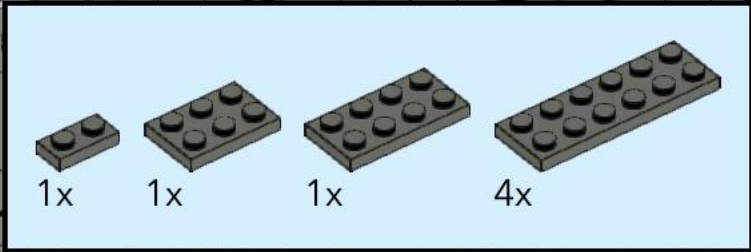

# 148

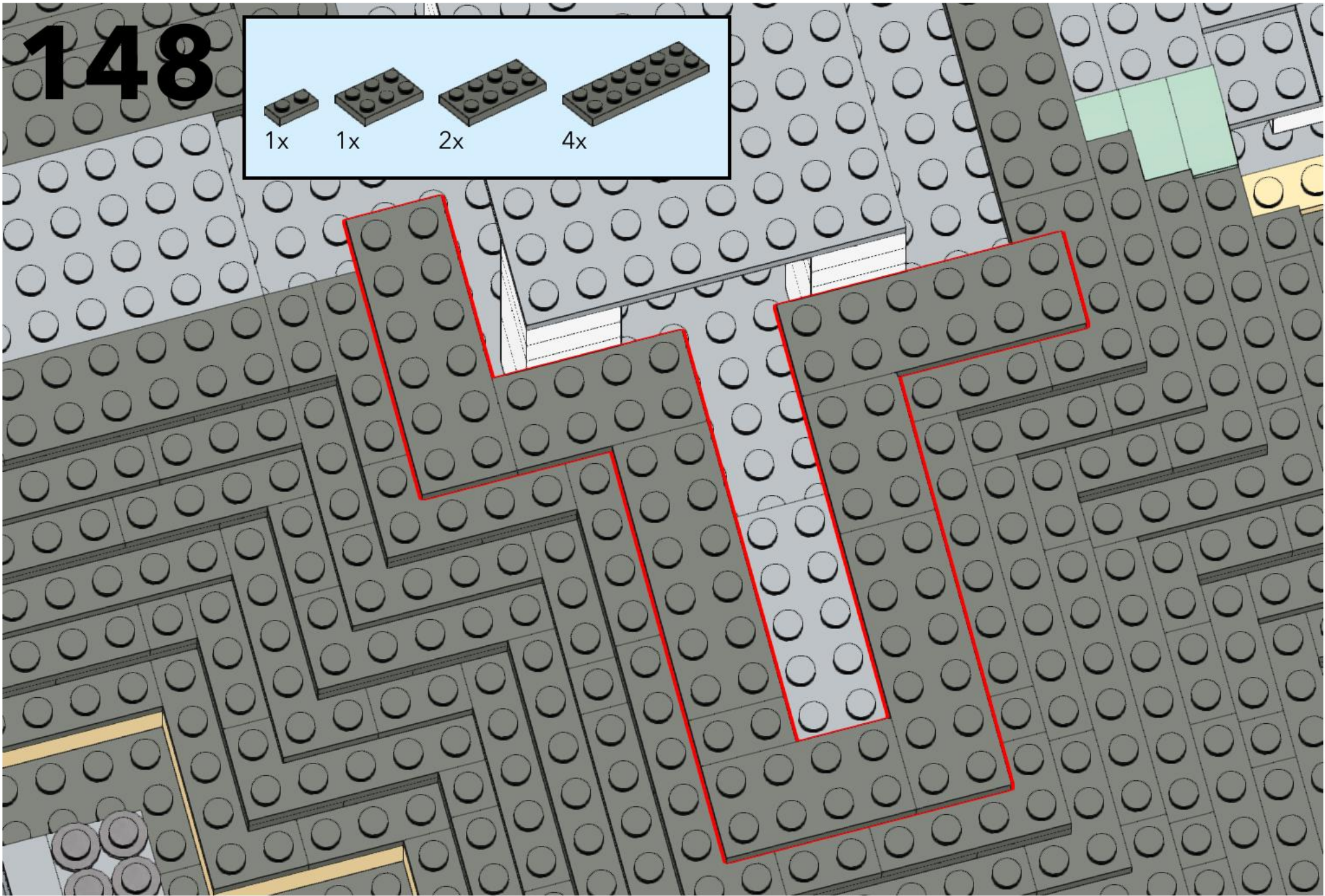
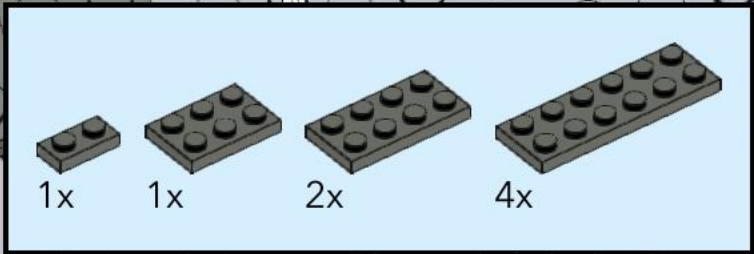

# 149

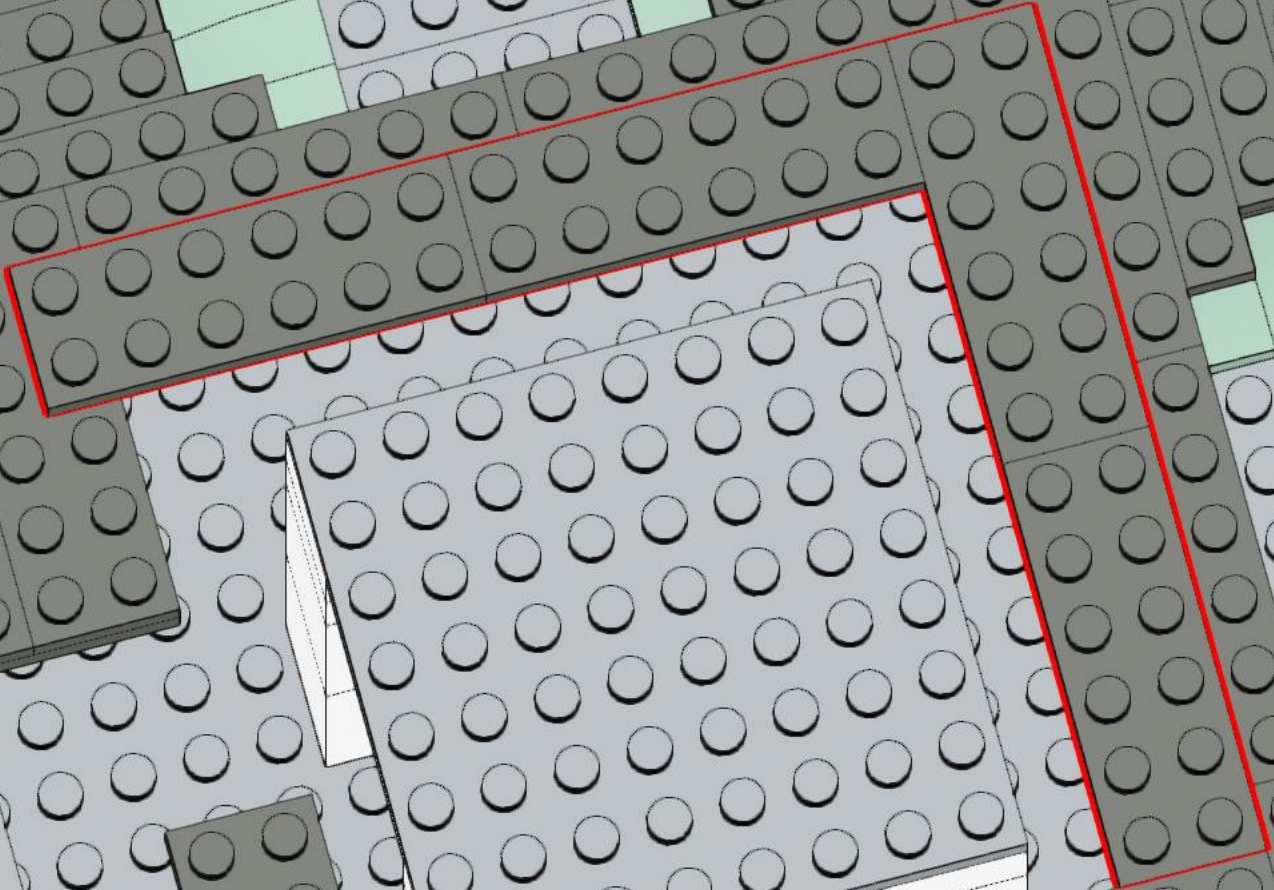
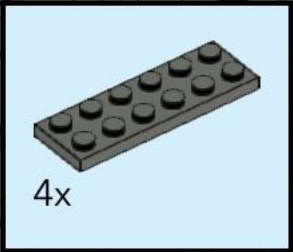

# 150

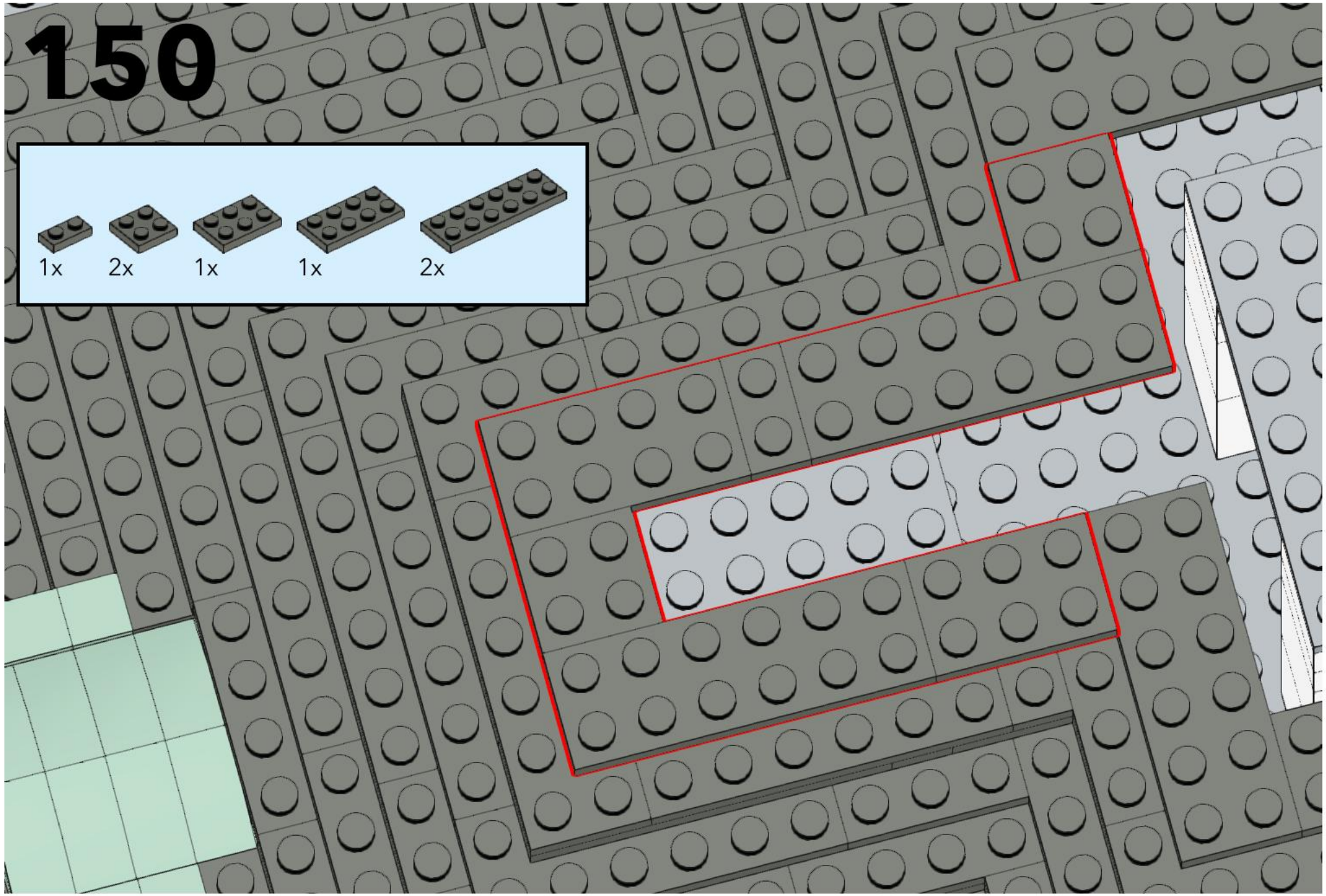
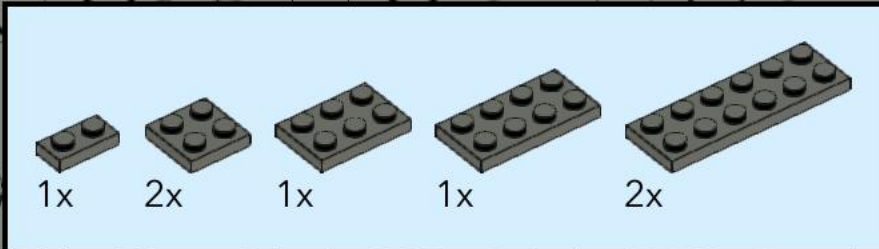

# 151

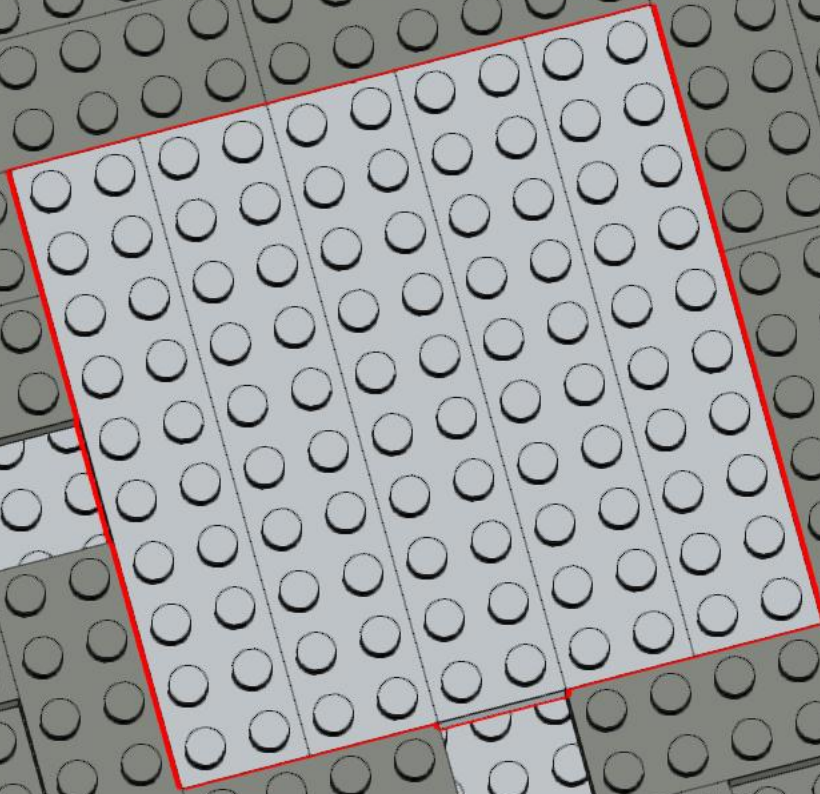
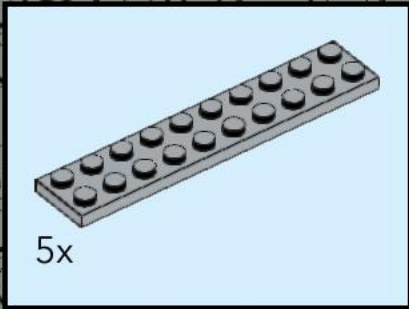



# 152

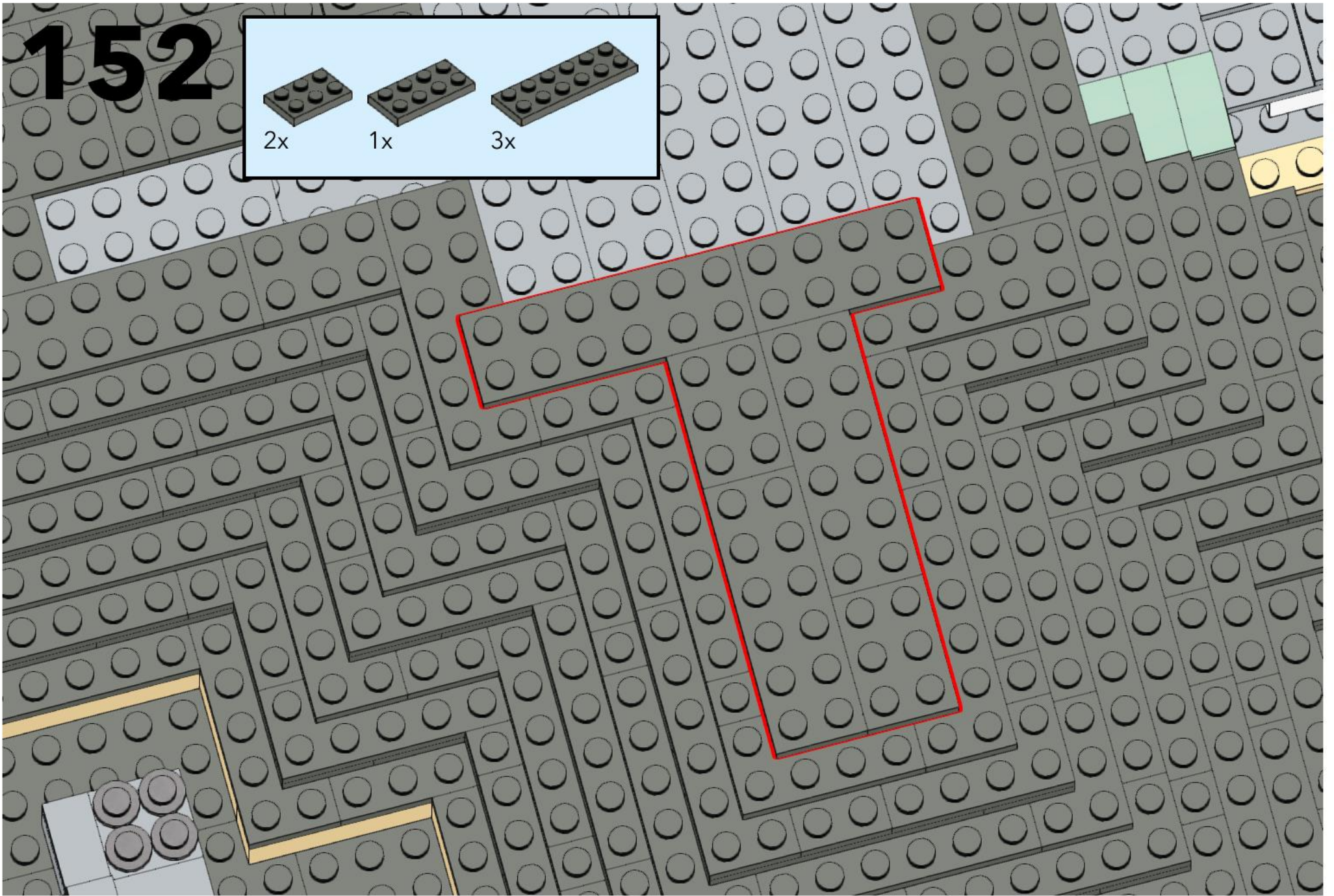
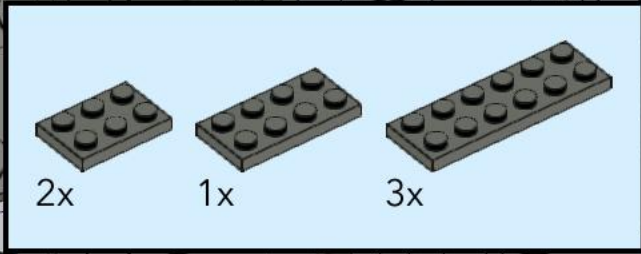

# 153

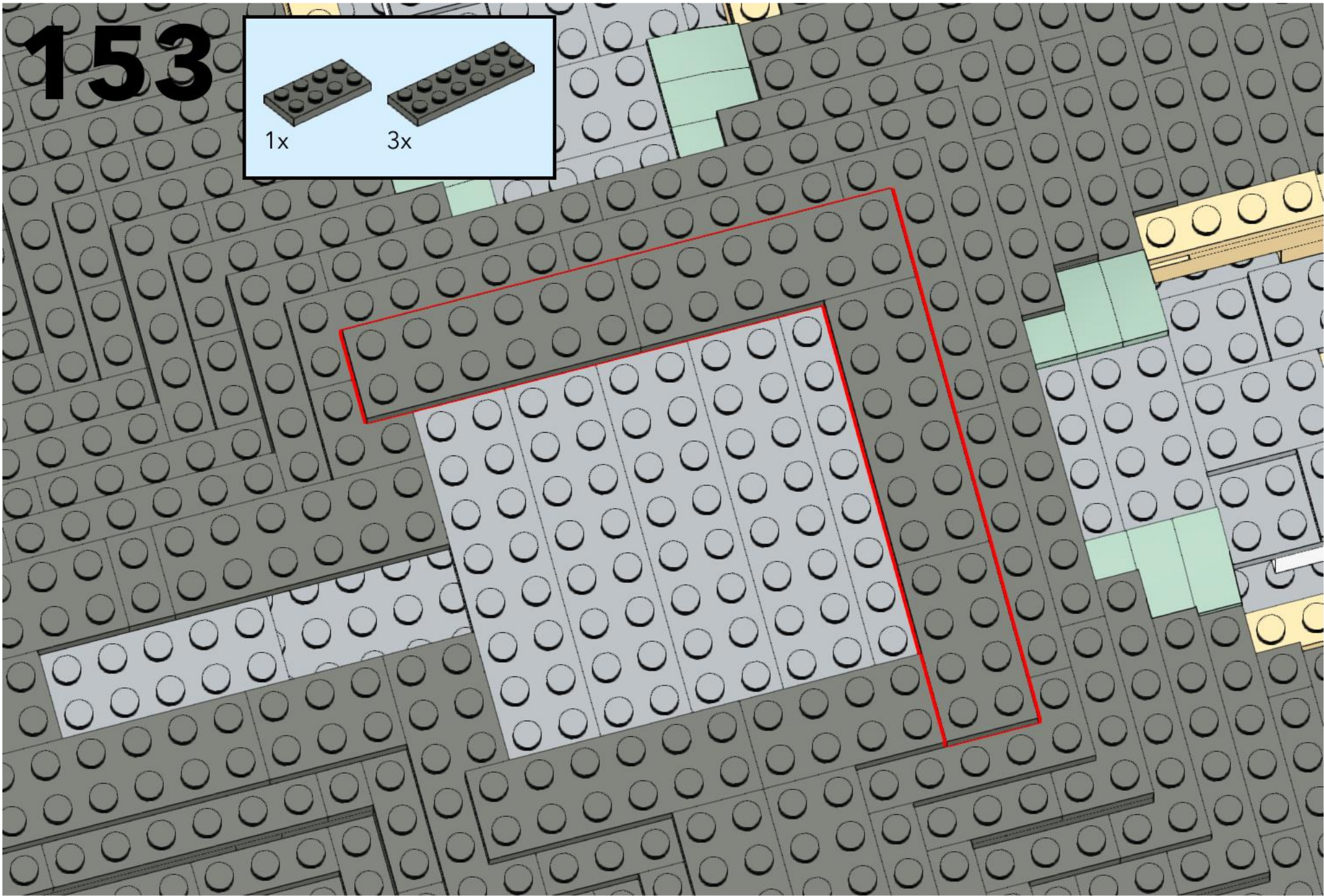
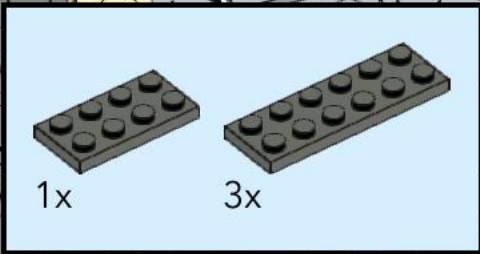

# 154

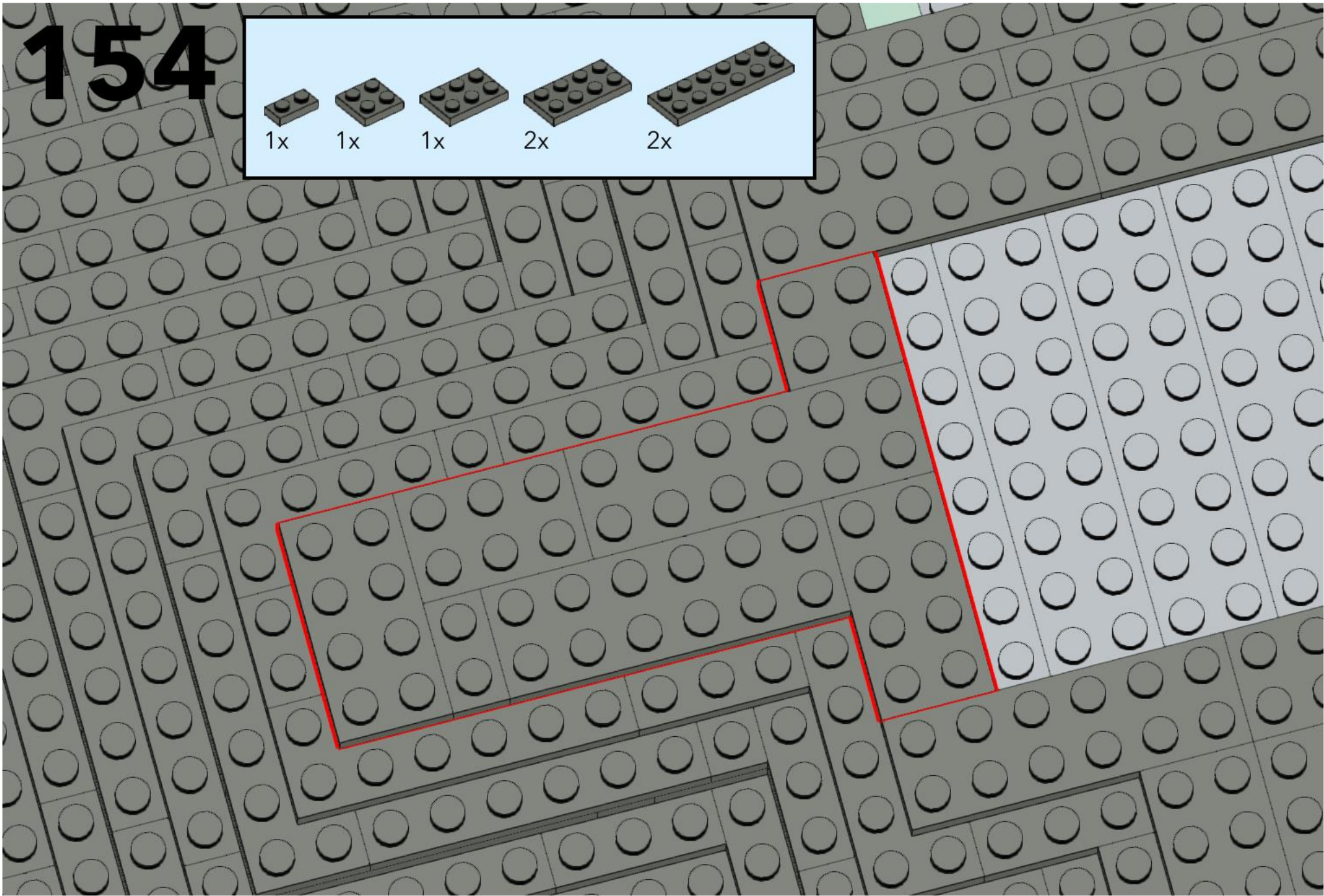
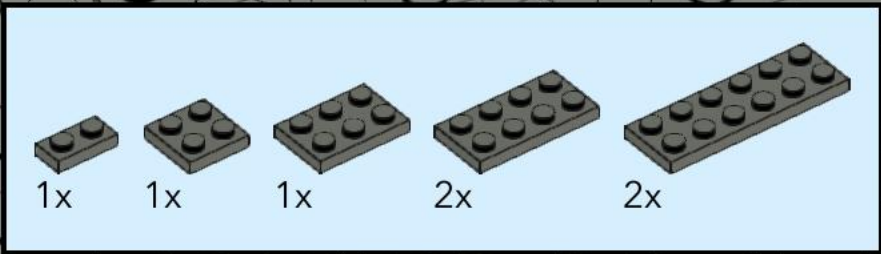

# 155

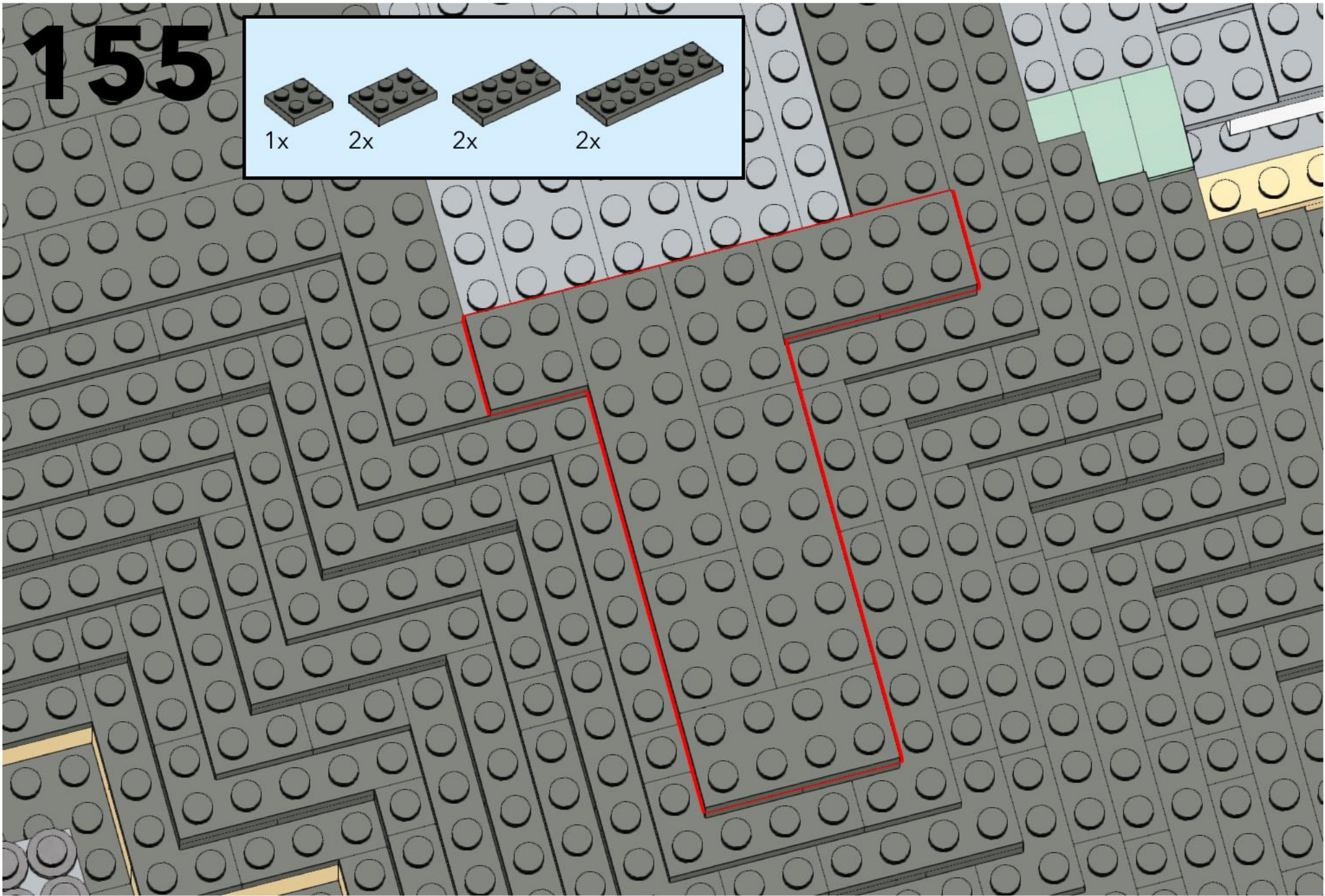
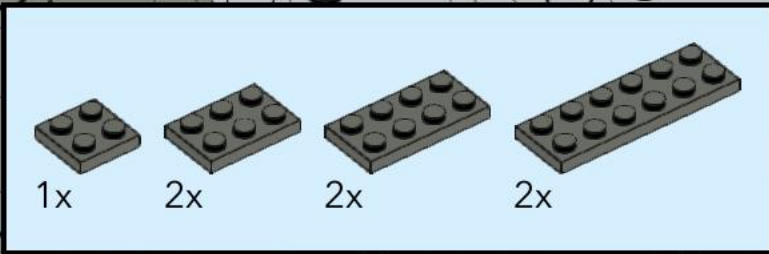

# 156

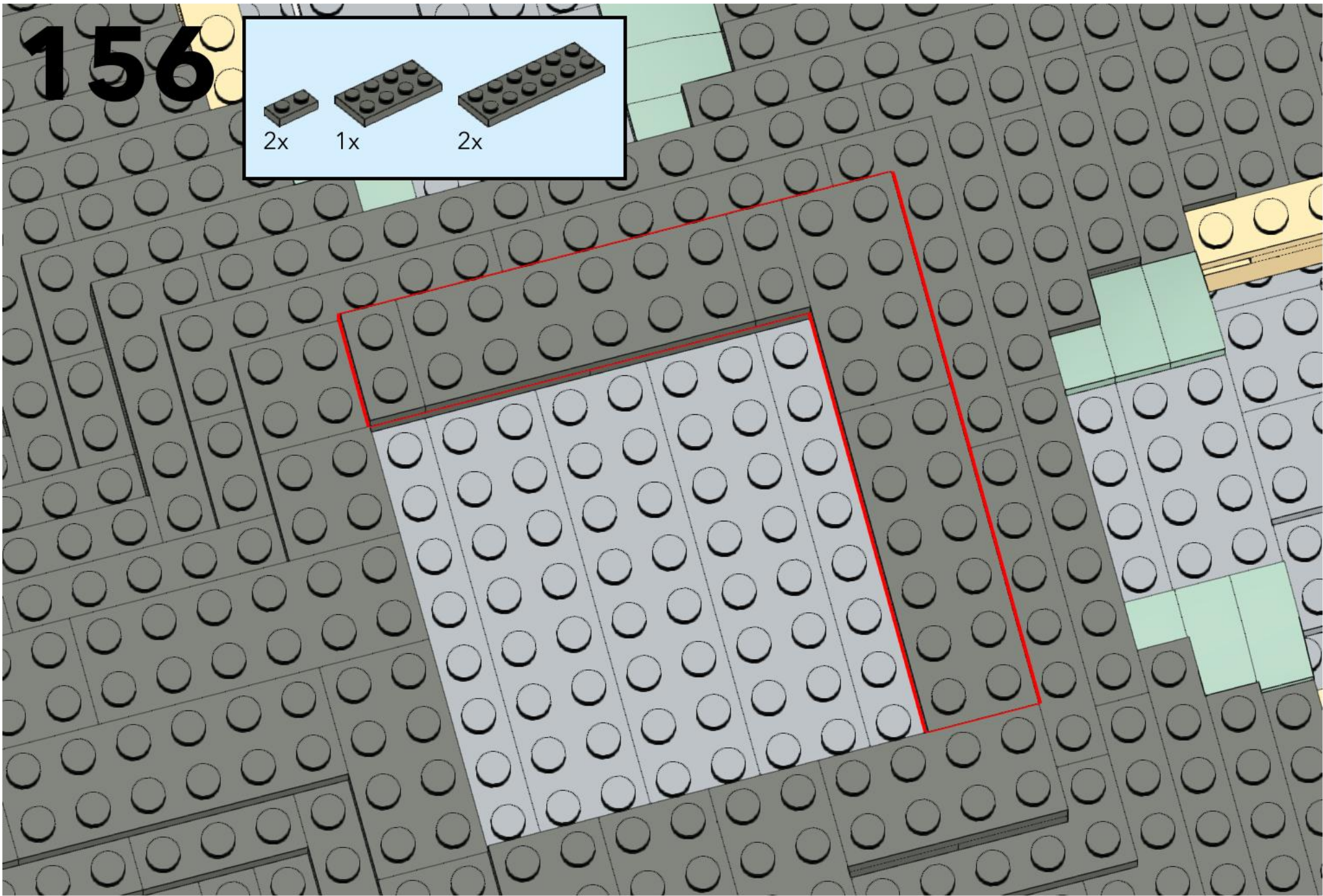
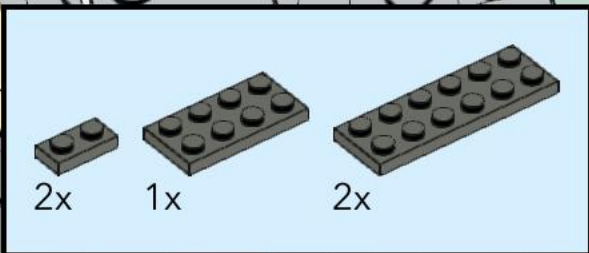

# 157

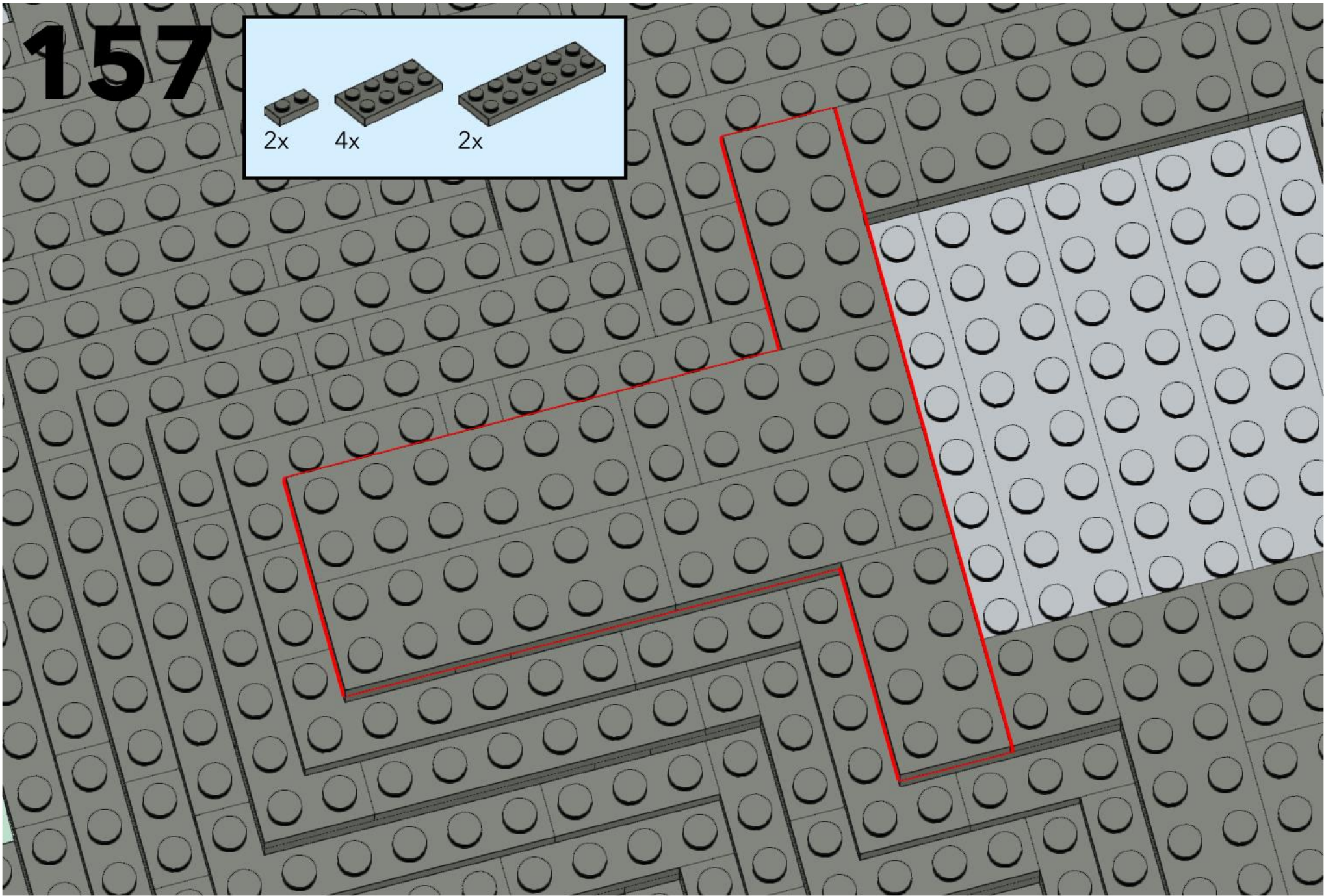
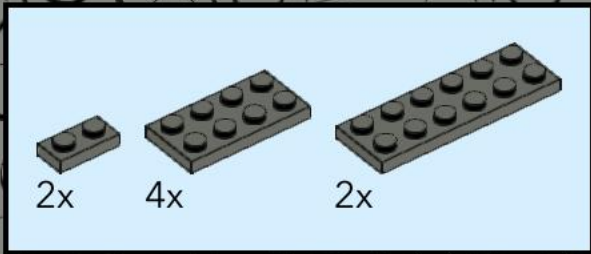



# 159

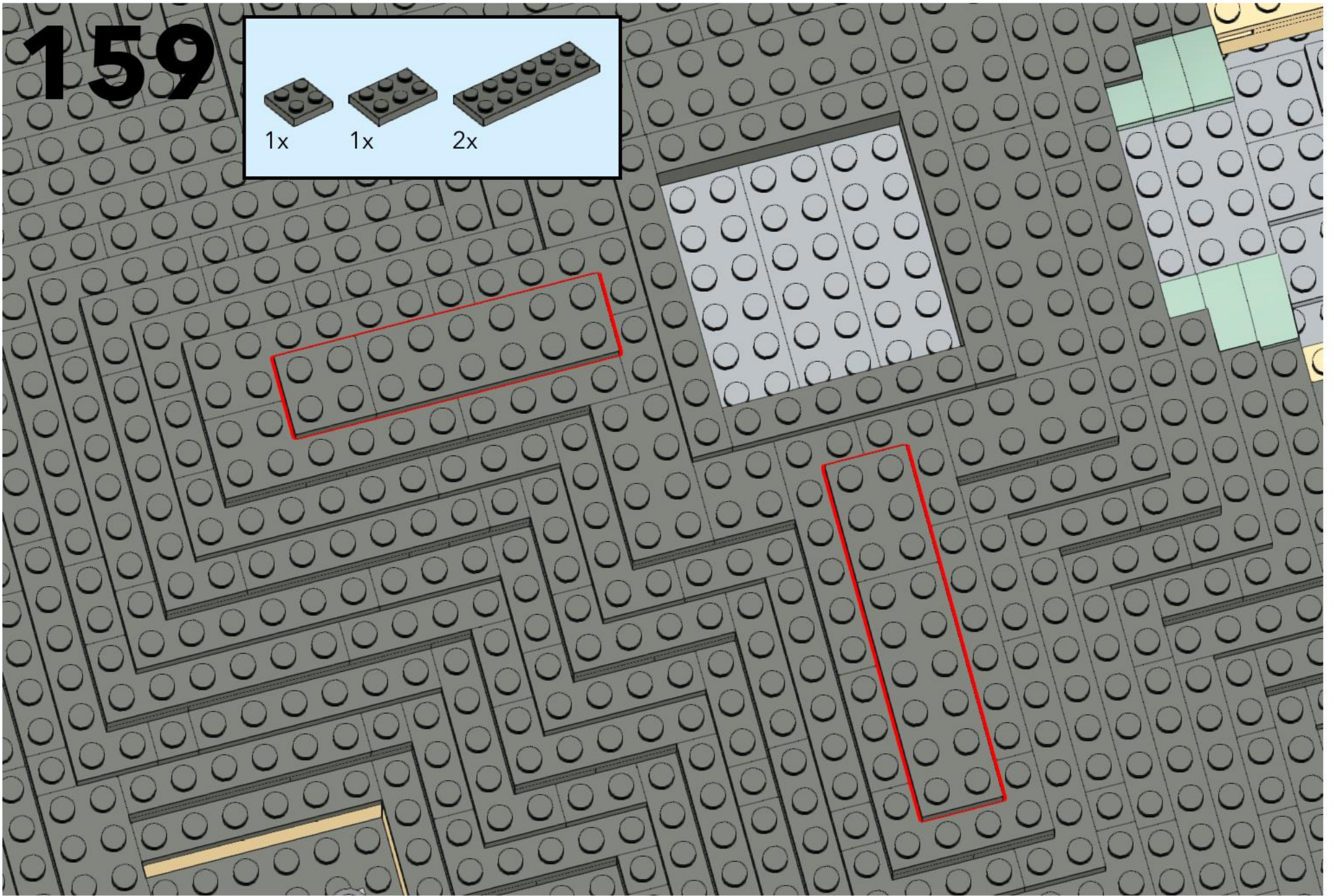
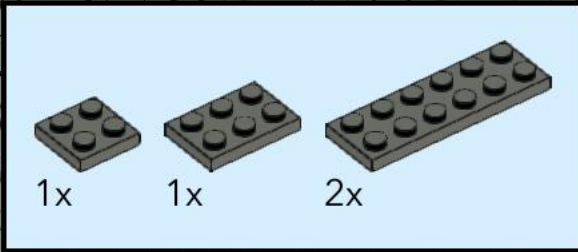



# 160

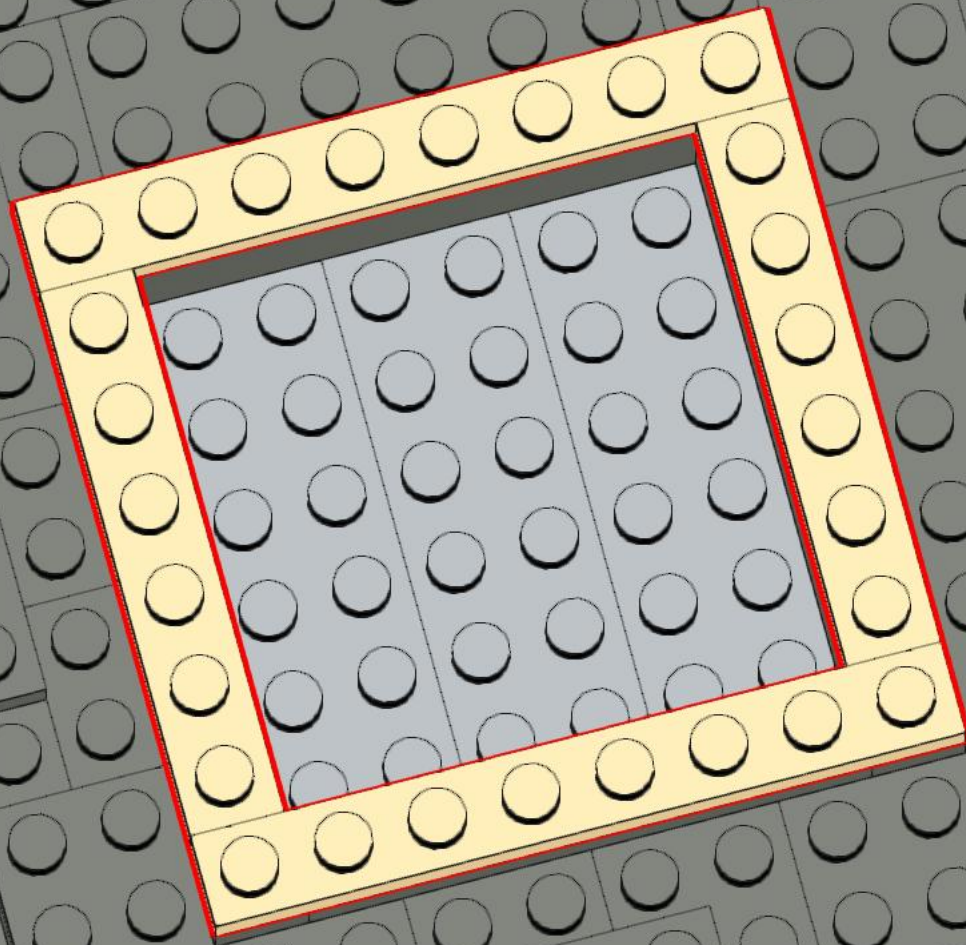
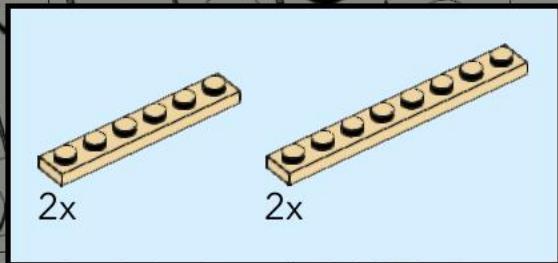

# 161

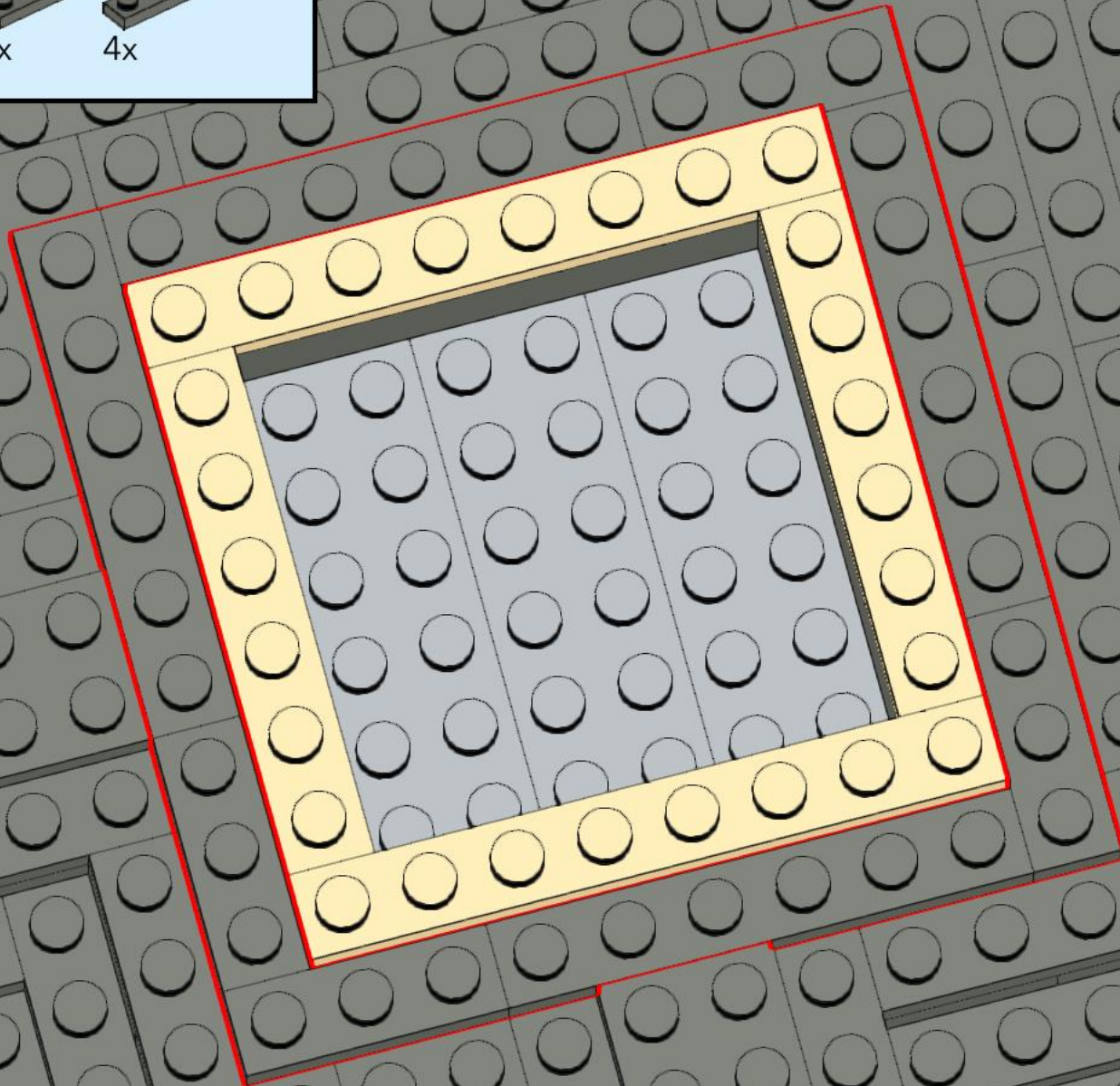
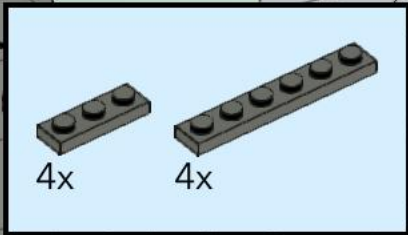

# 162

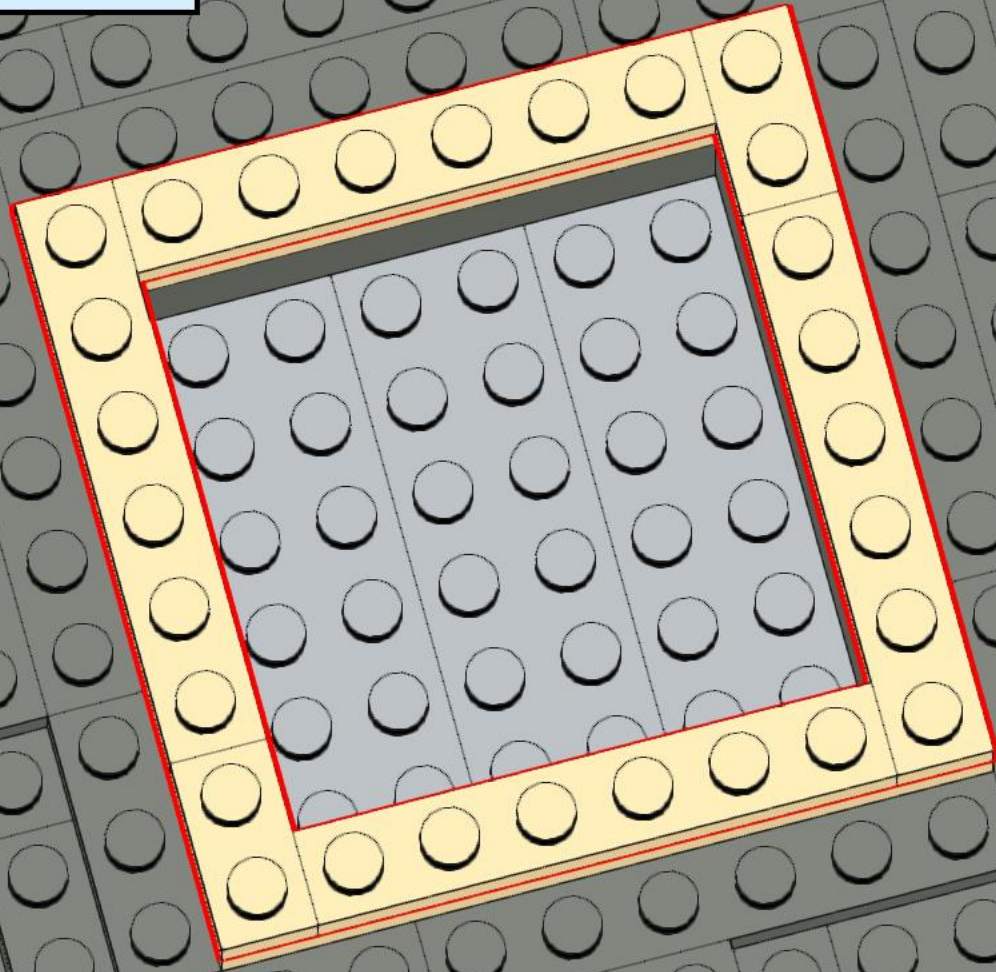
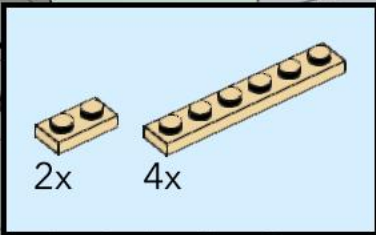

163

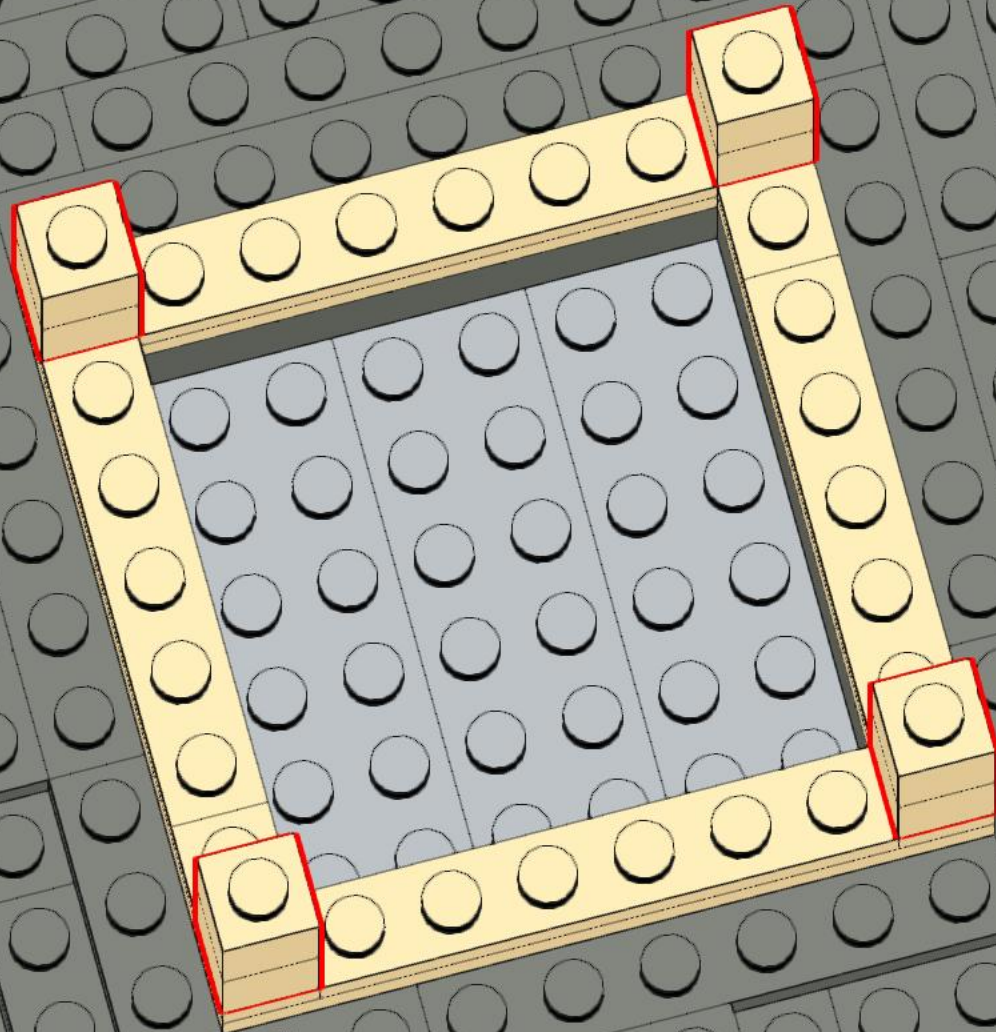
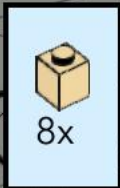

# 164

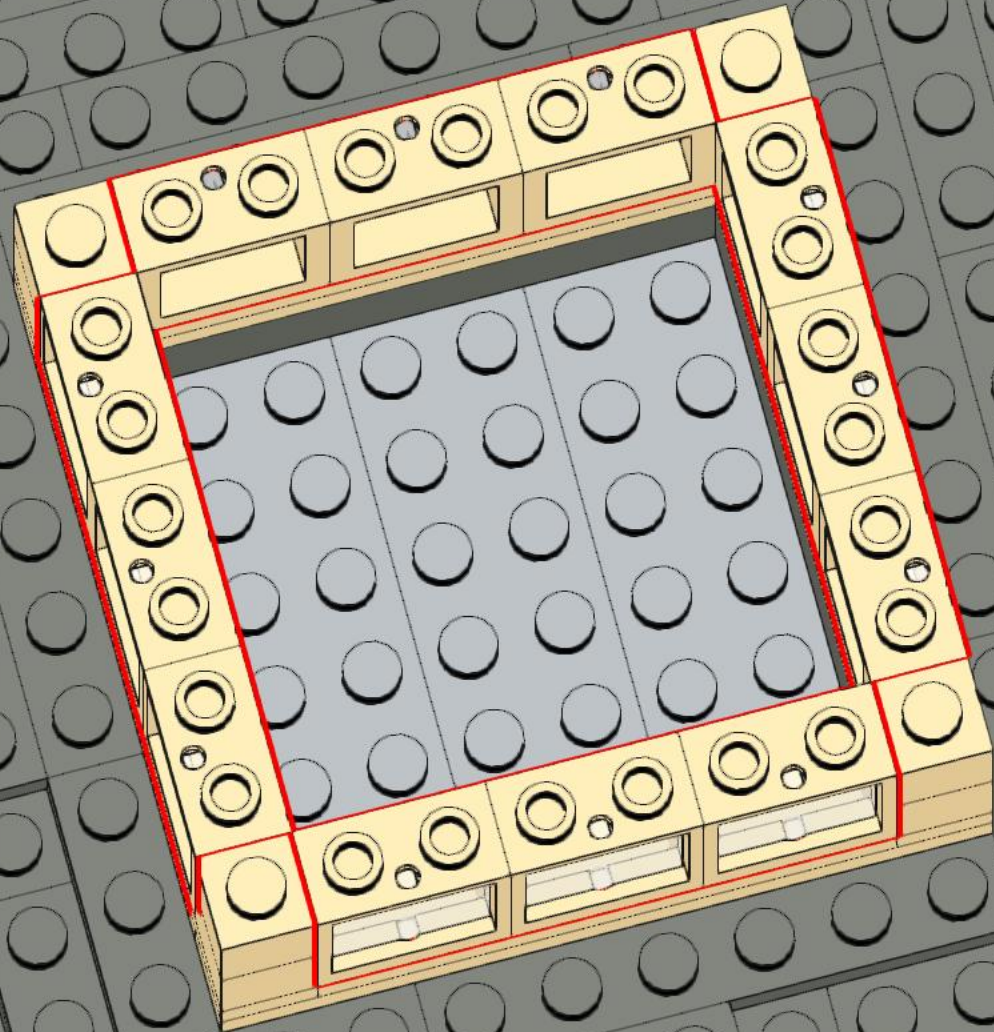
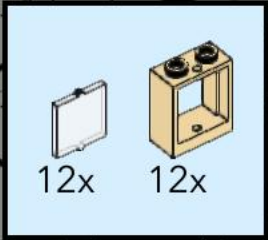

# 165

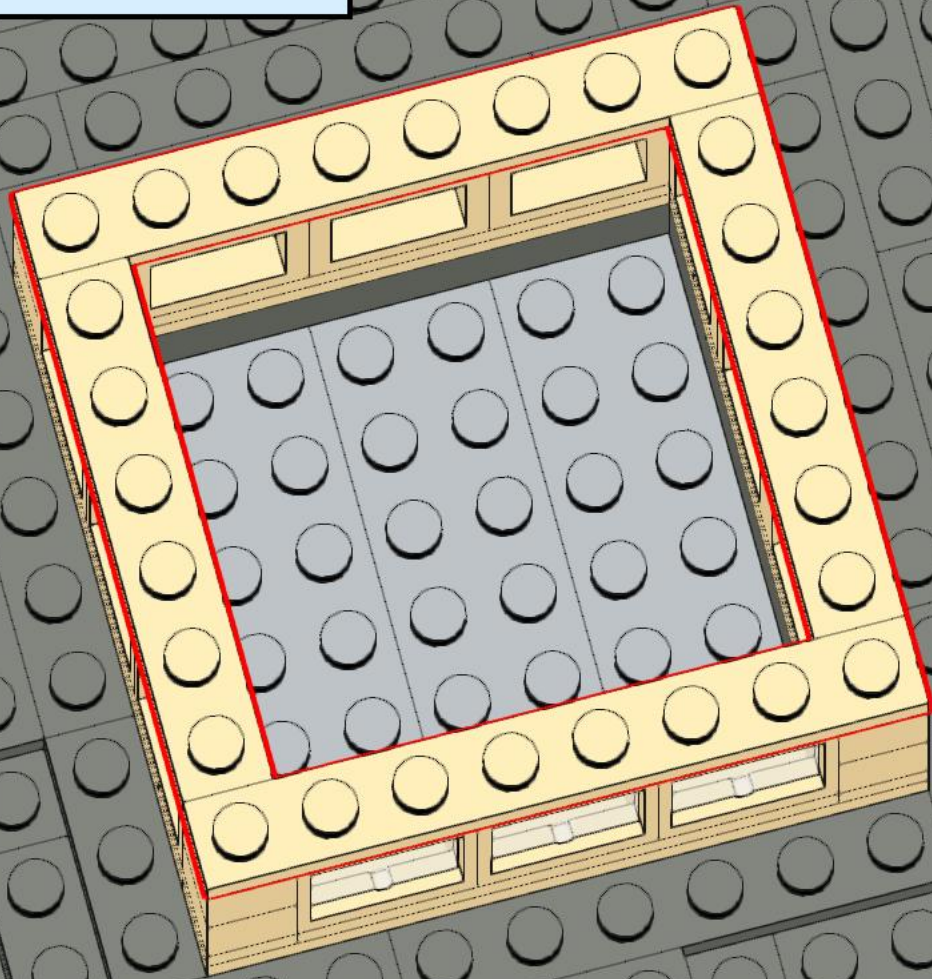
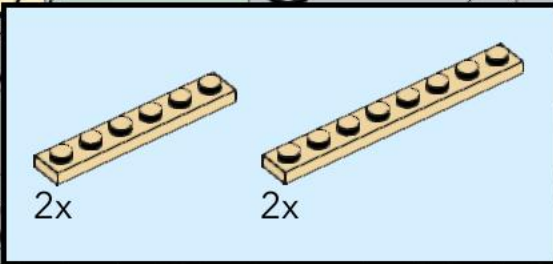

# 166

1x 1x 15x

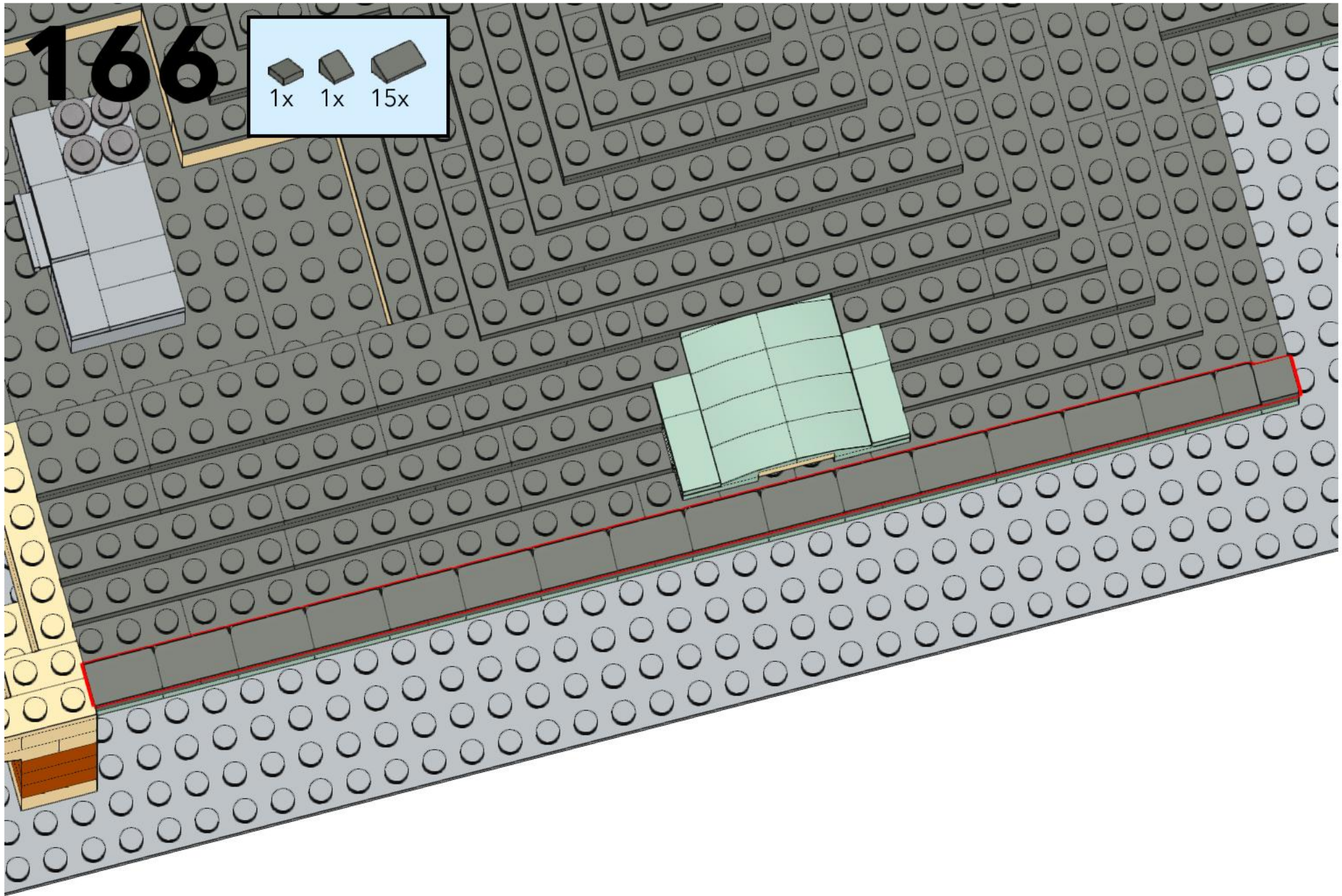

# 167

2x 2x 10x

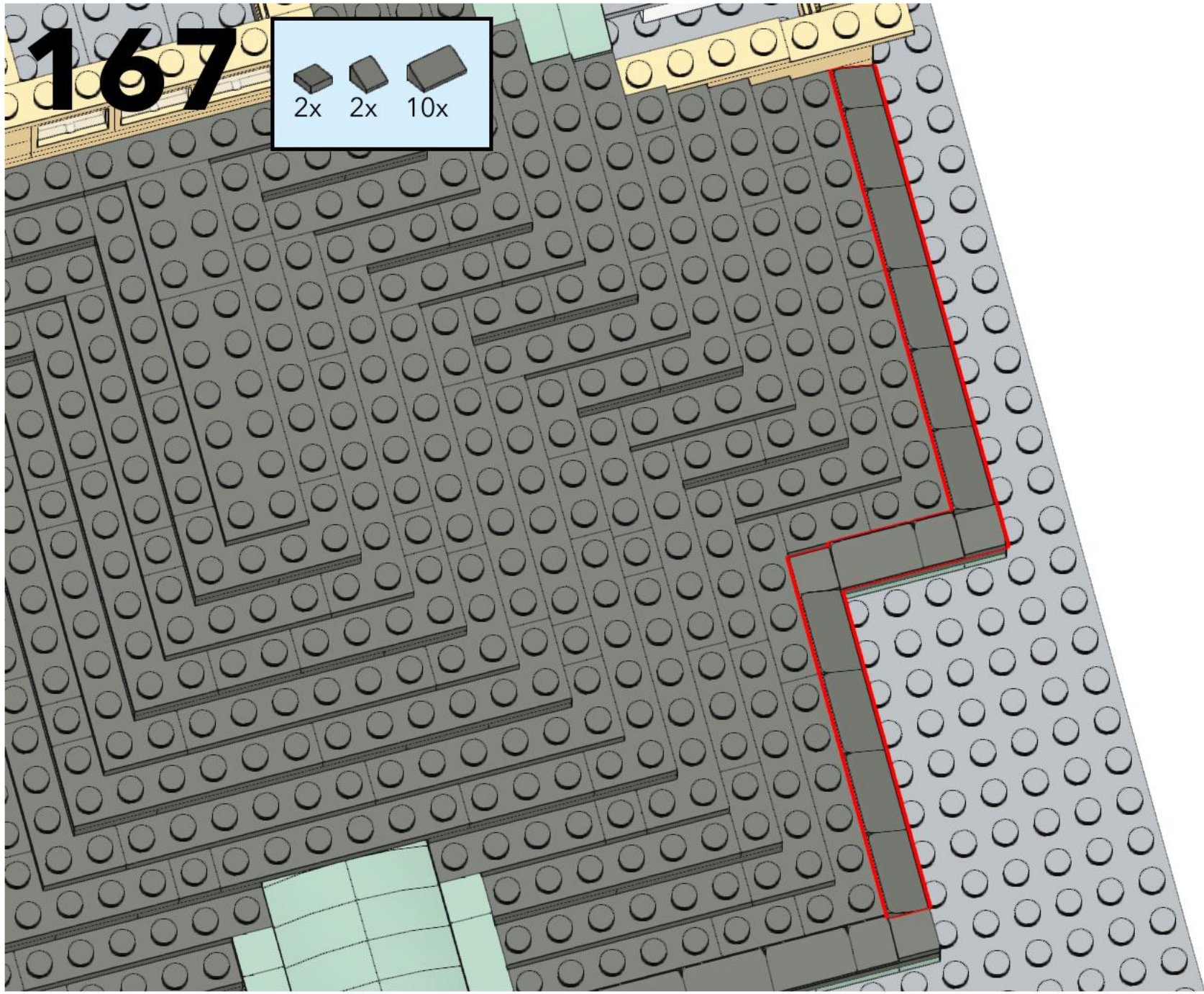



# 168

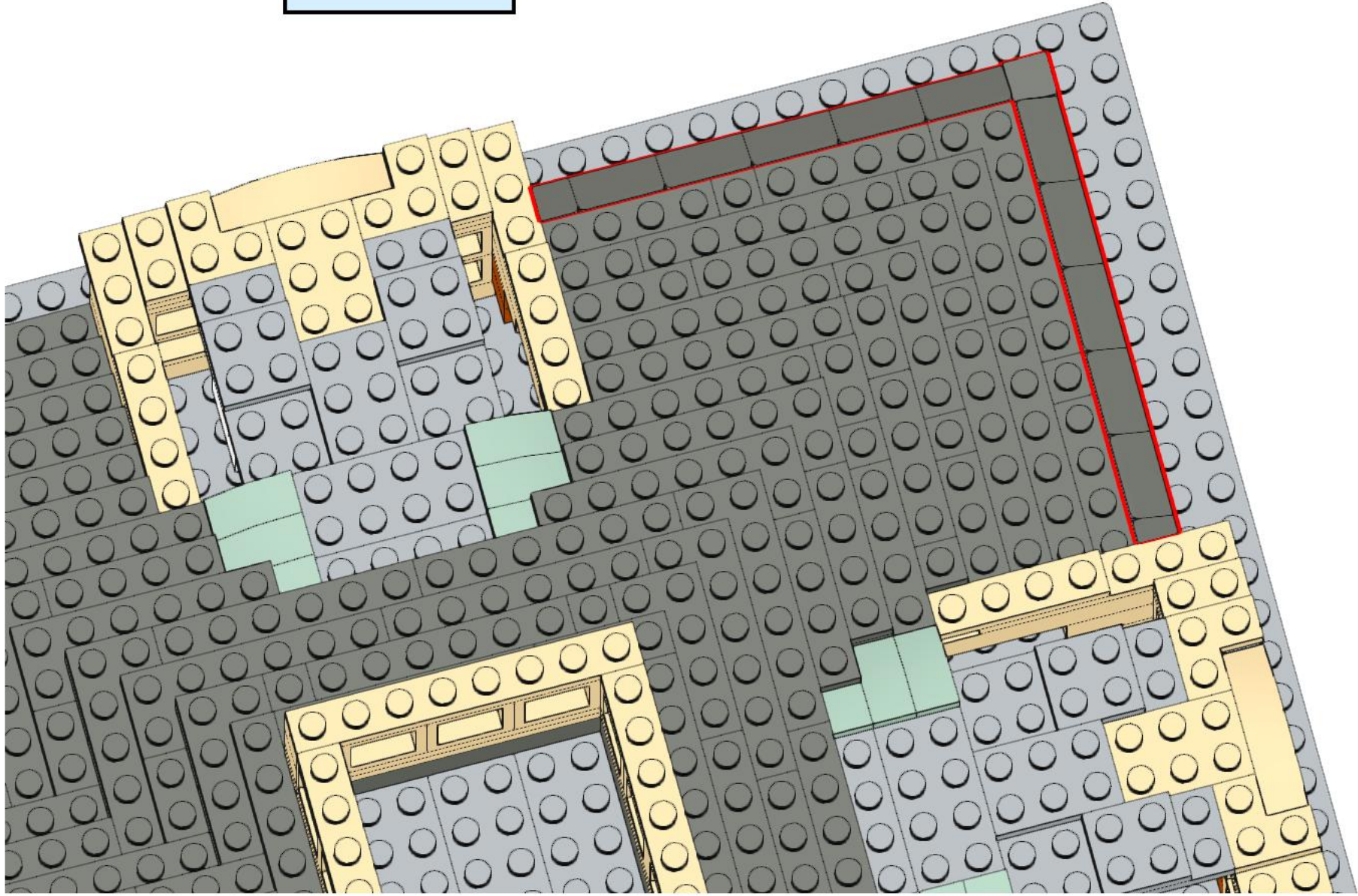
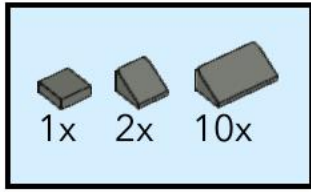

# 169

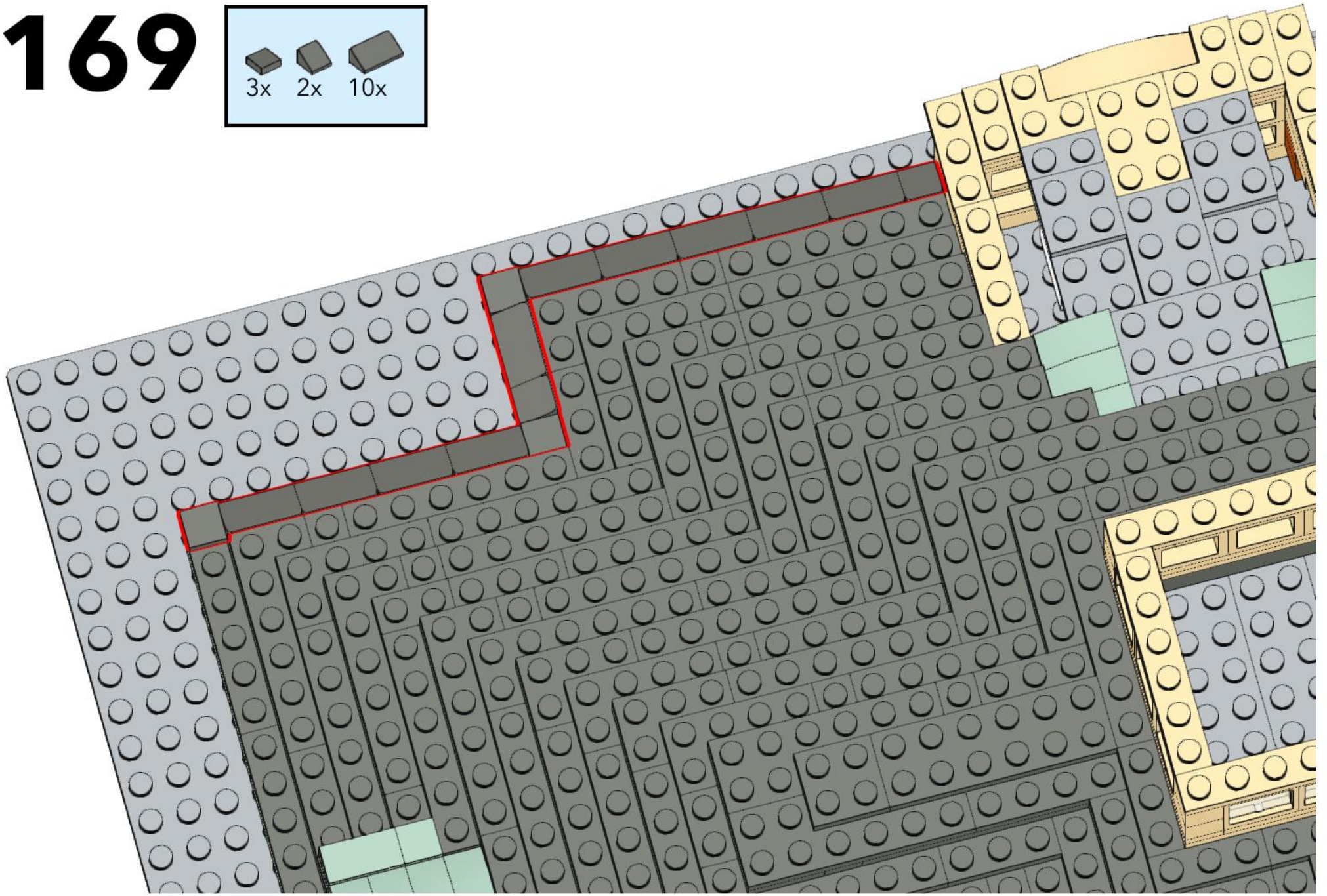
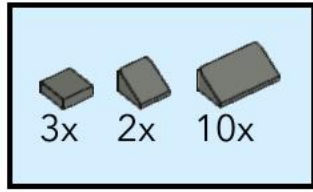

# 170

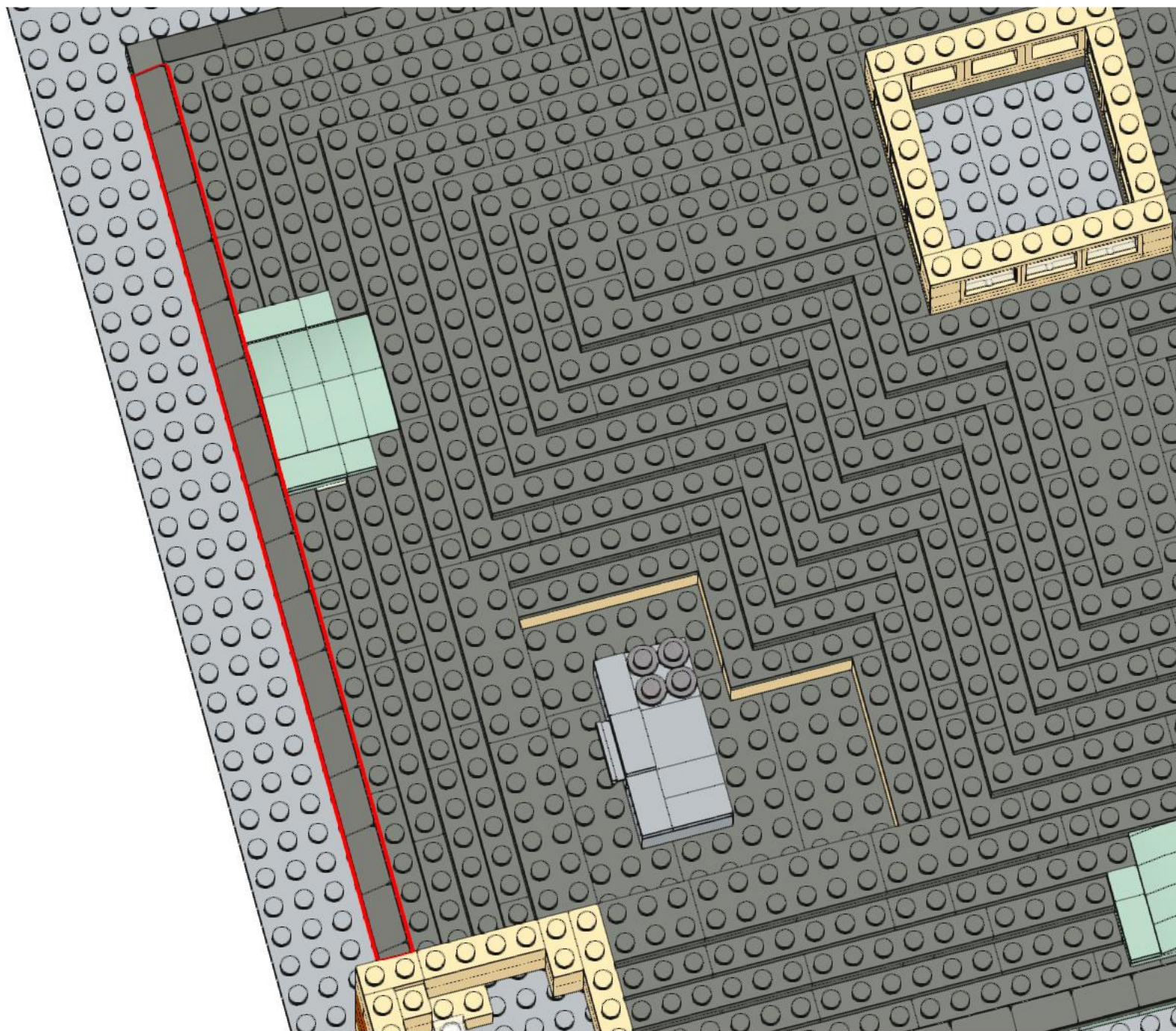
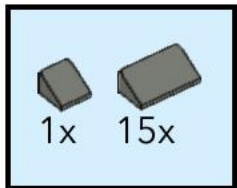

# 171

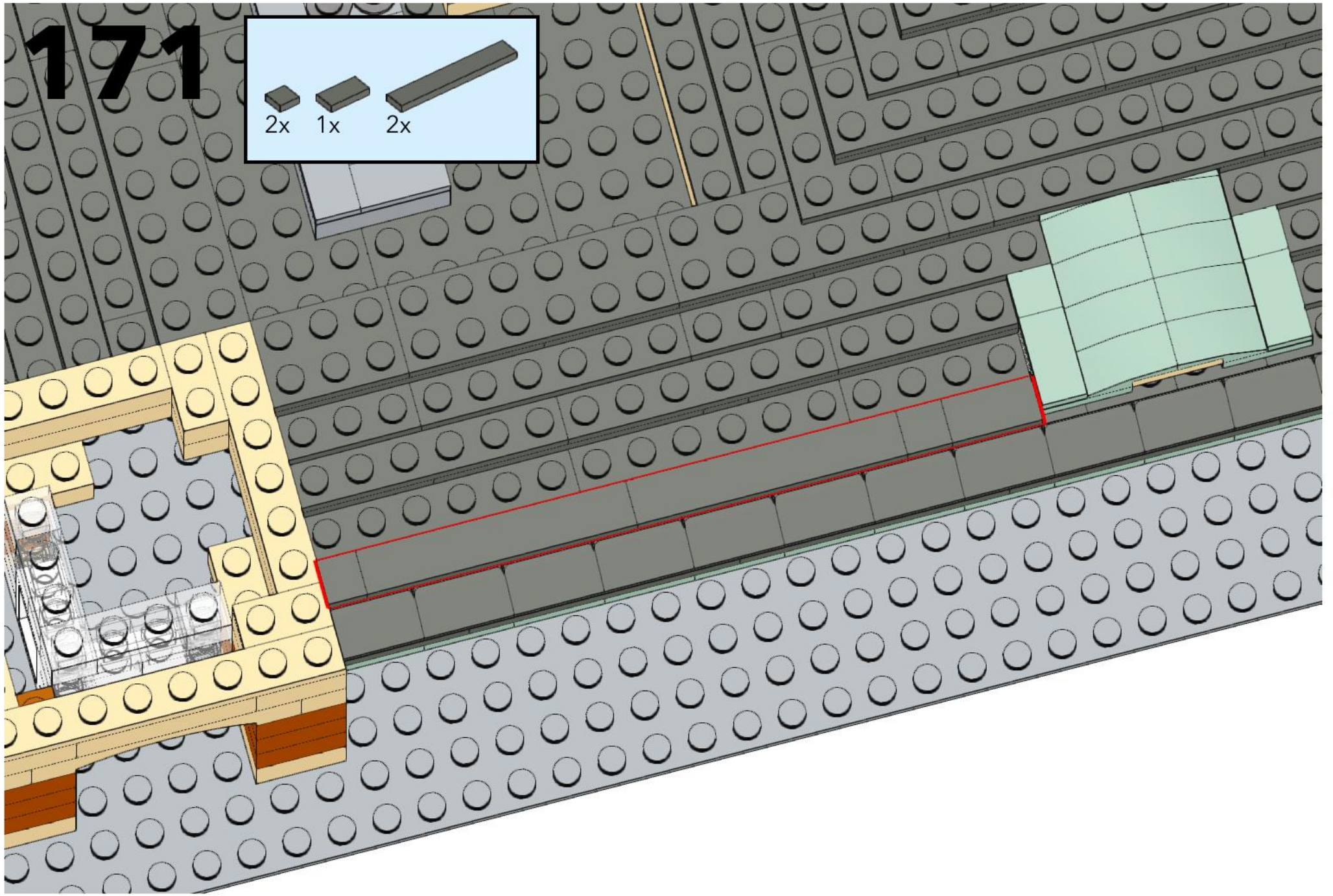
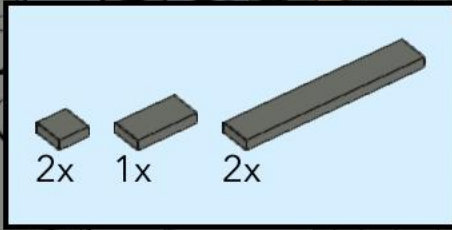

# 172

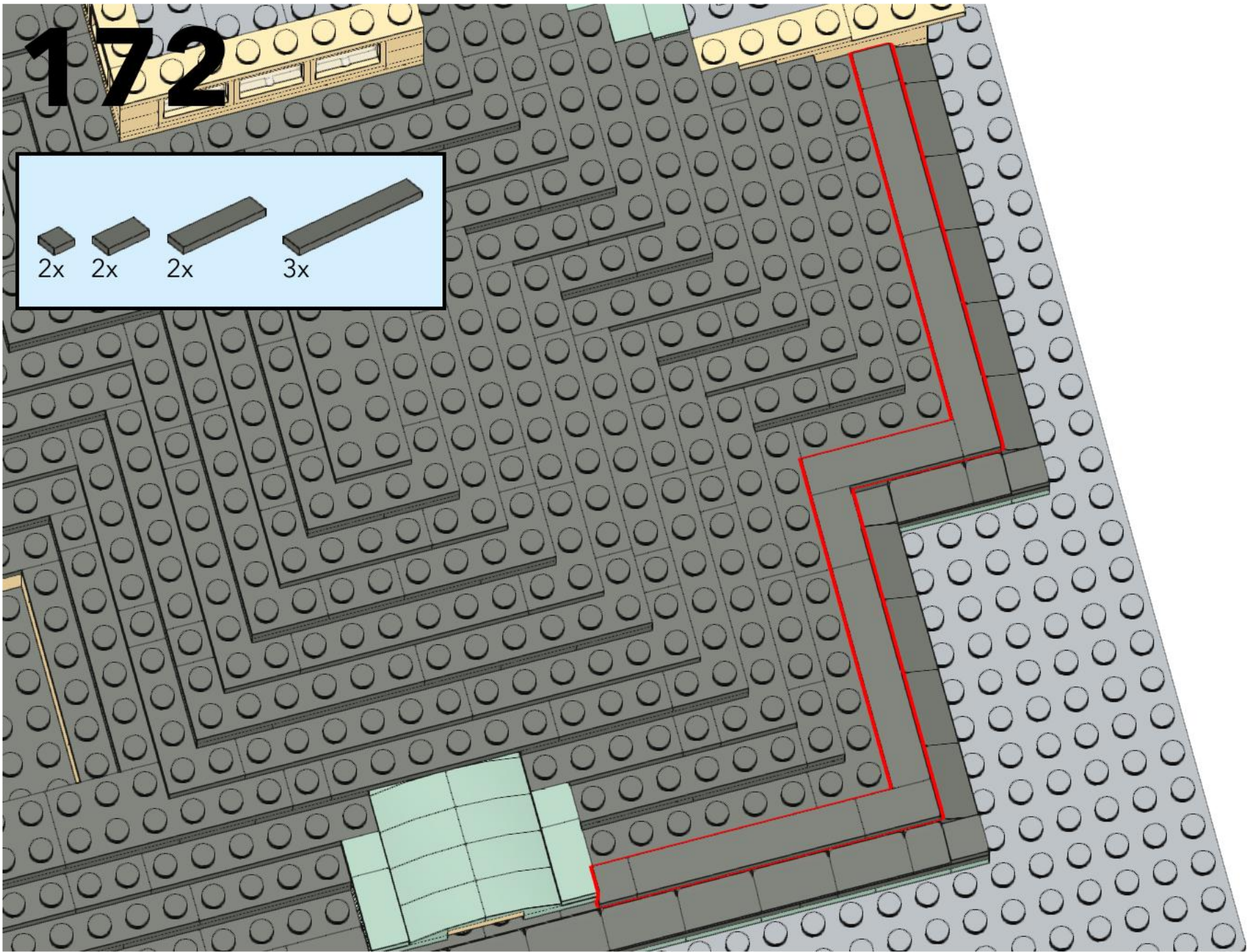
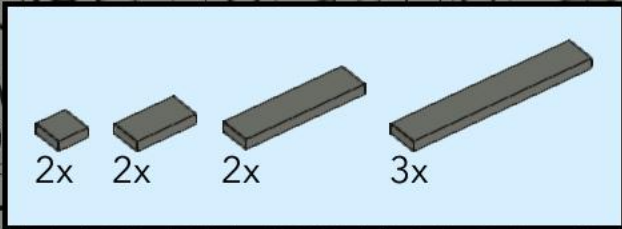

# 173

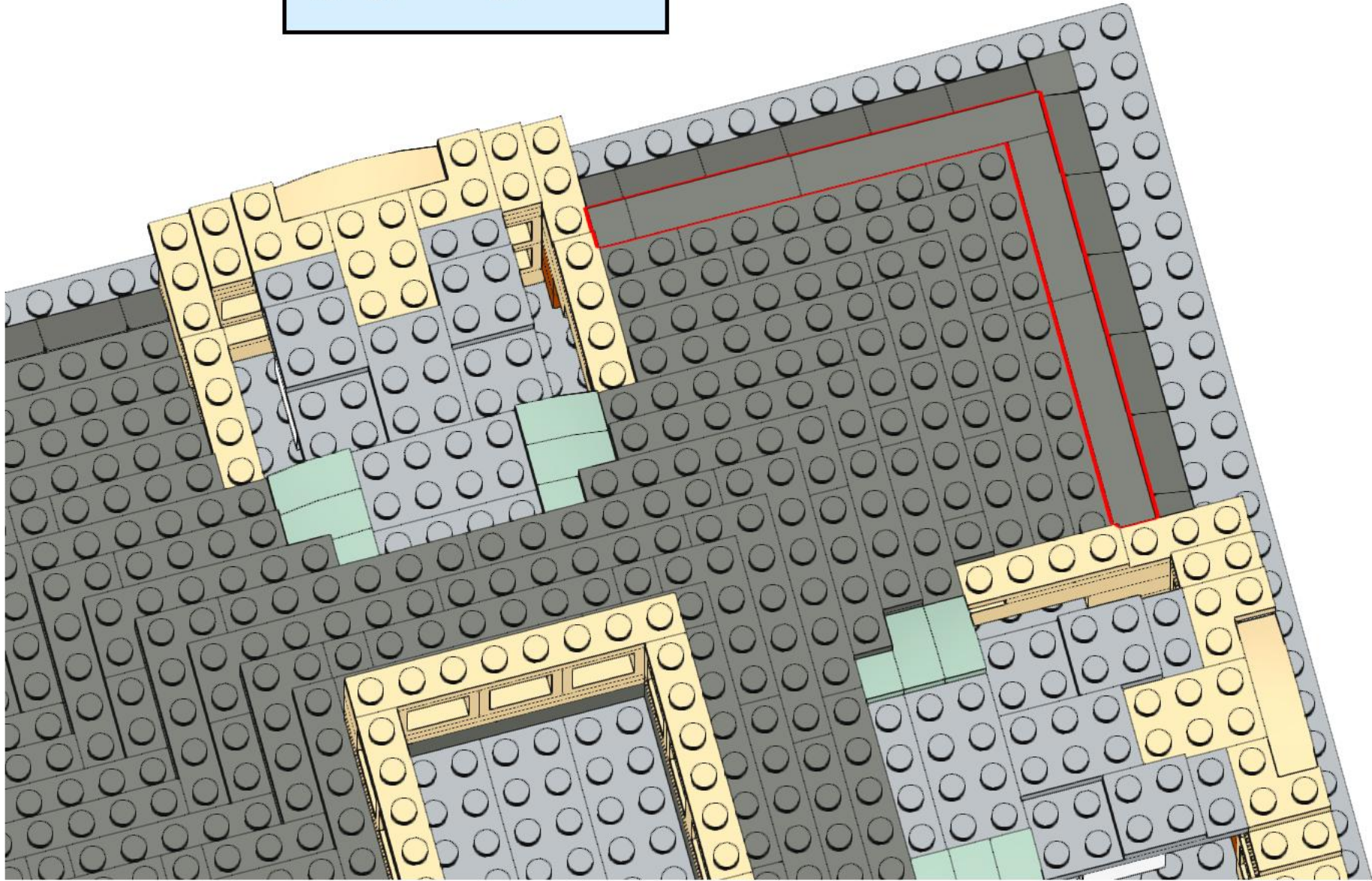
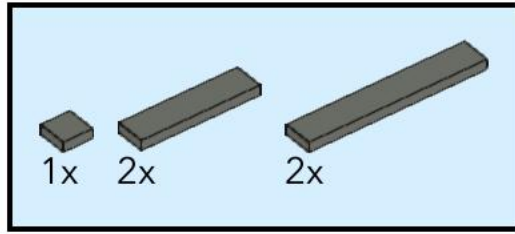

# 174

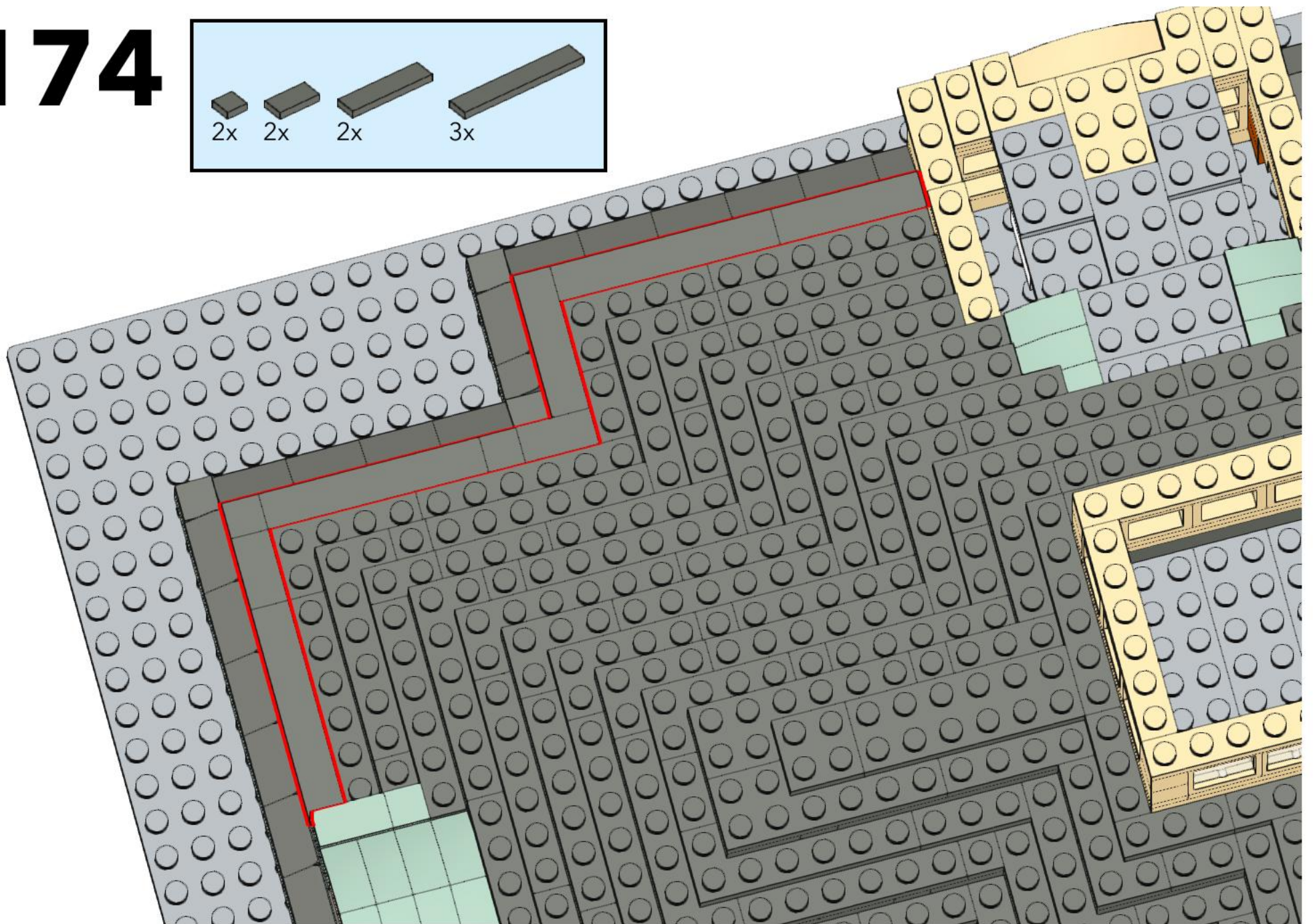
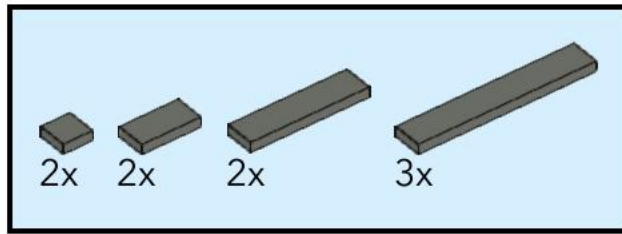







# 177

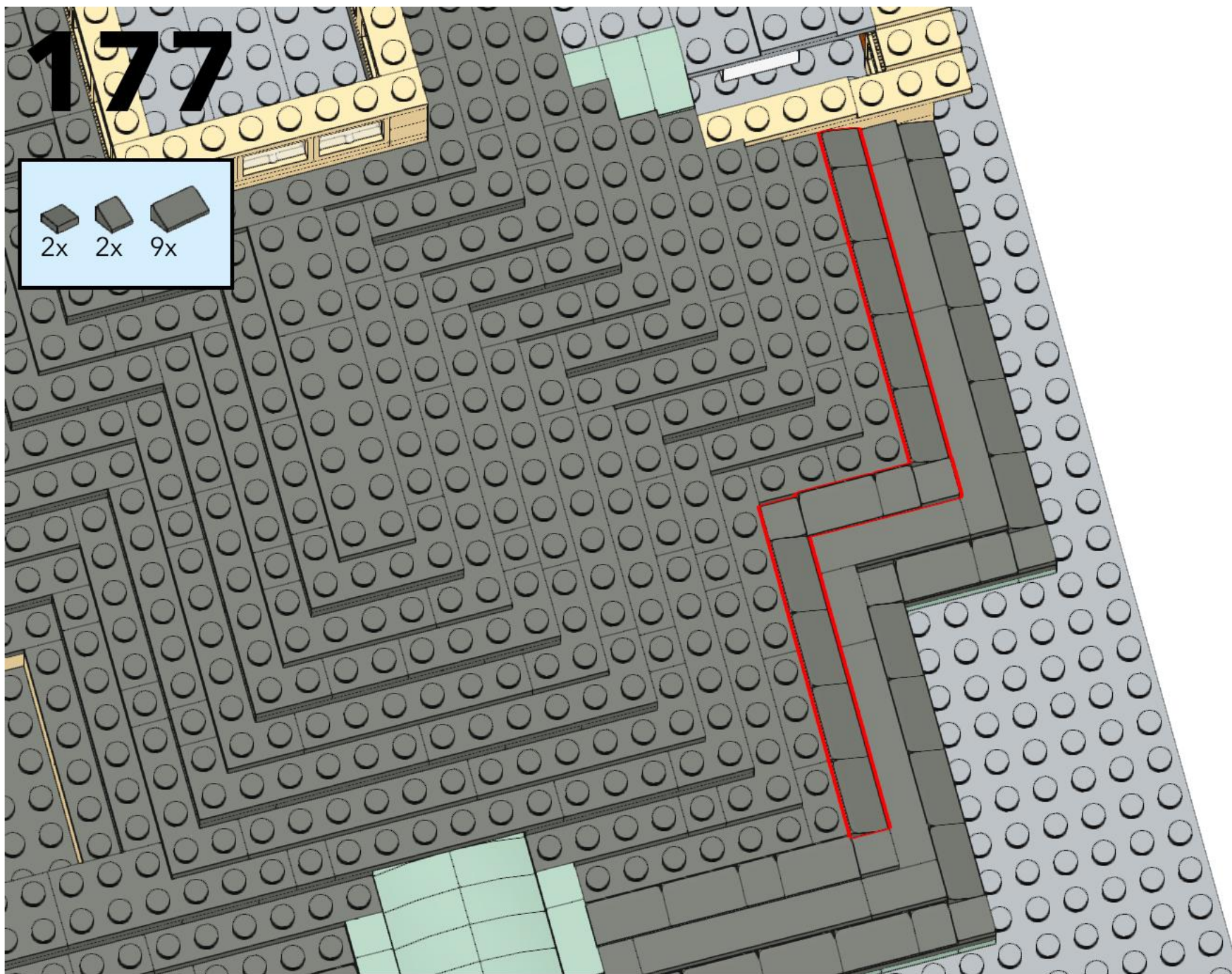
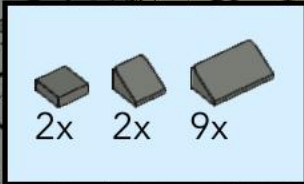

# 178

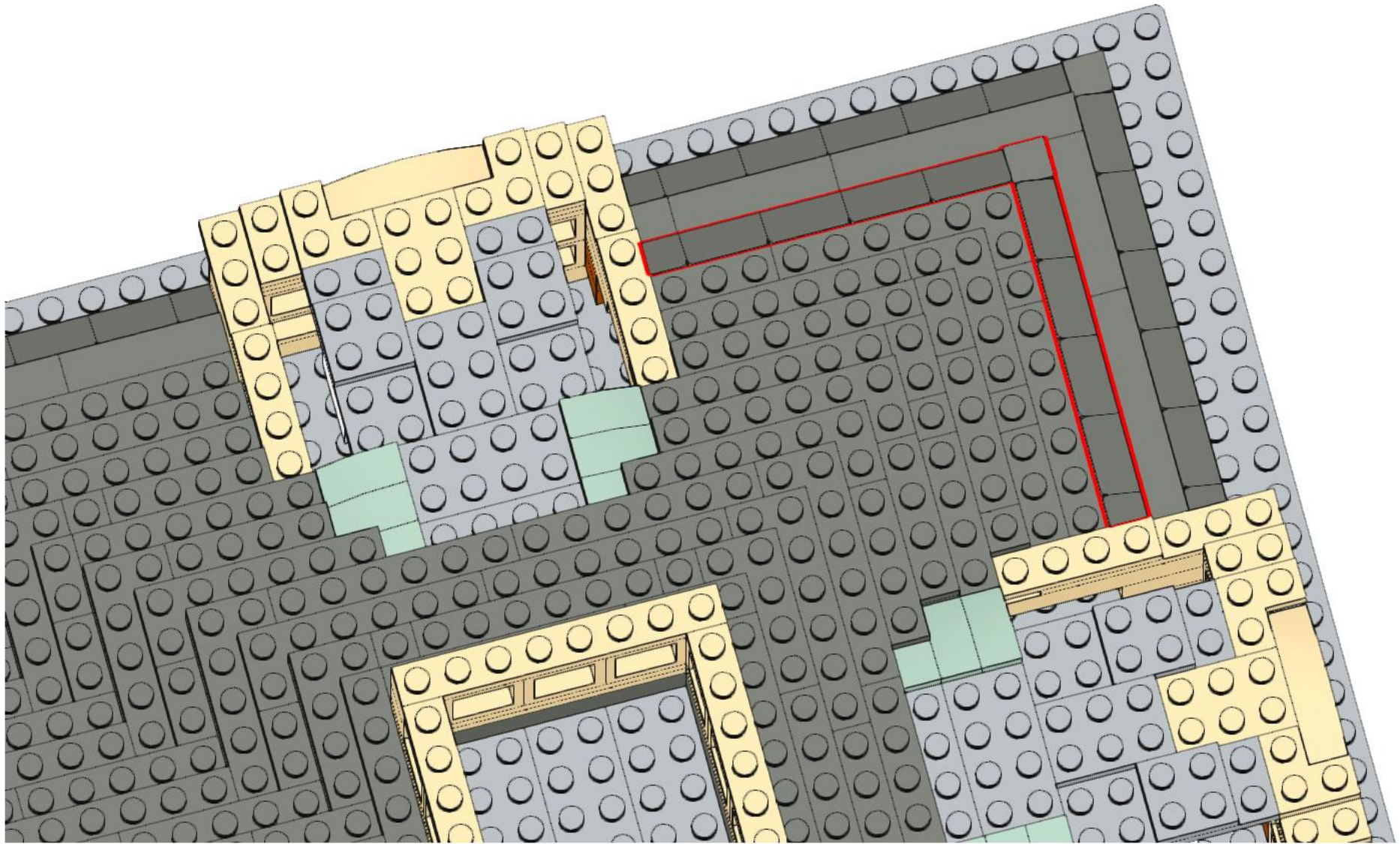
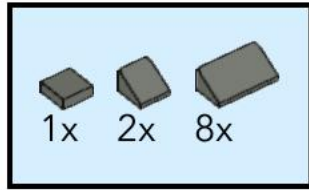

# 179

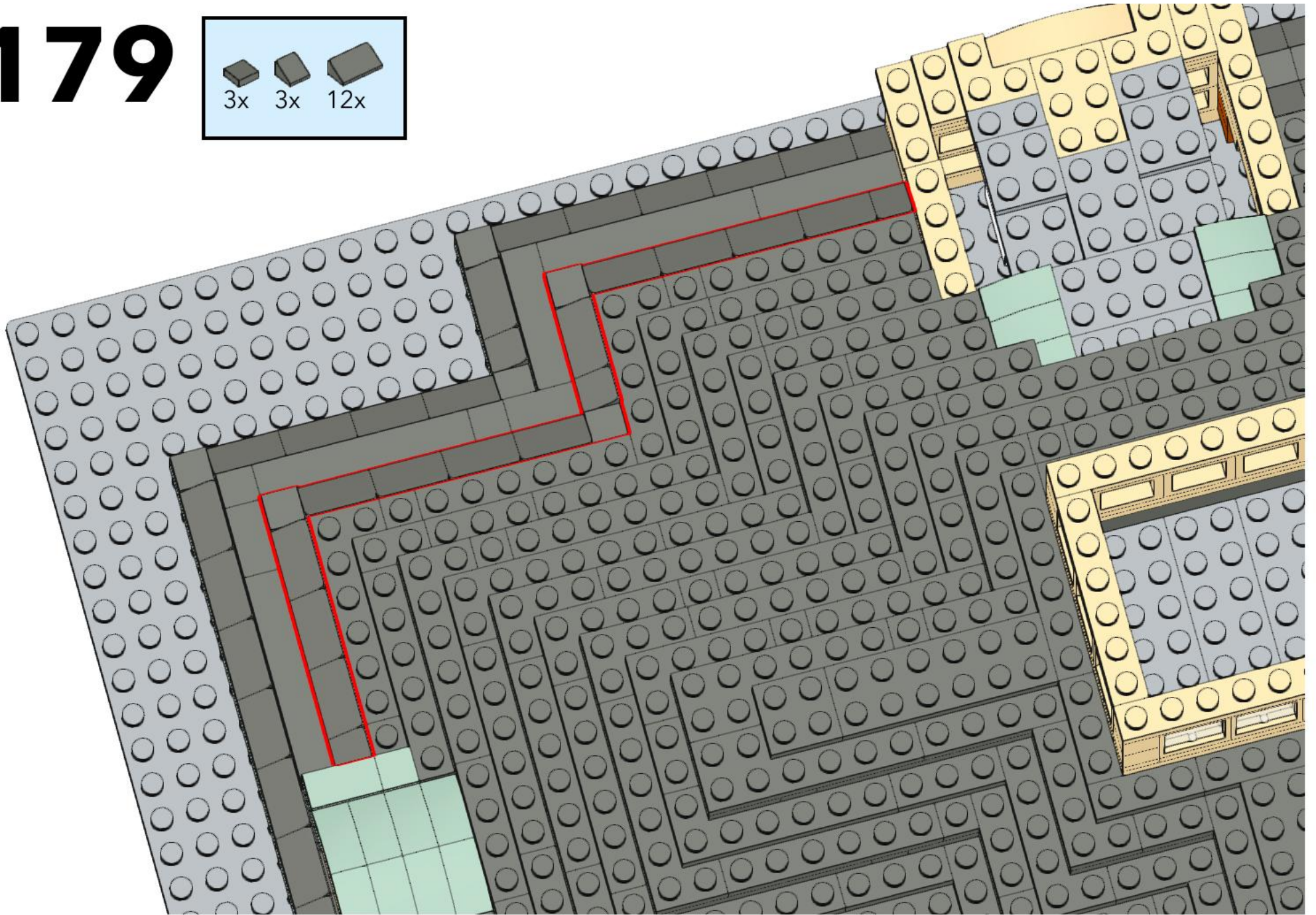
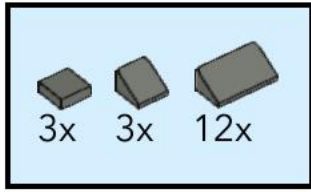

# 180

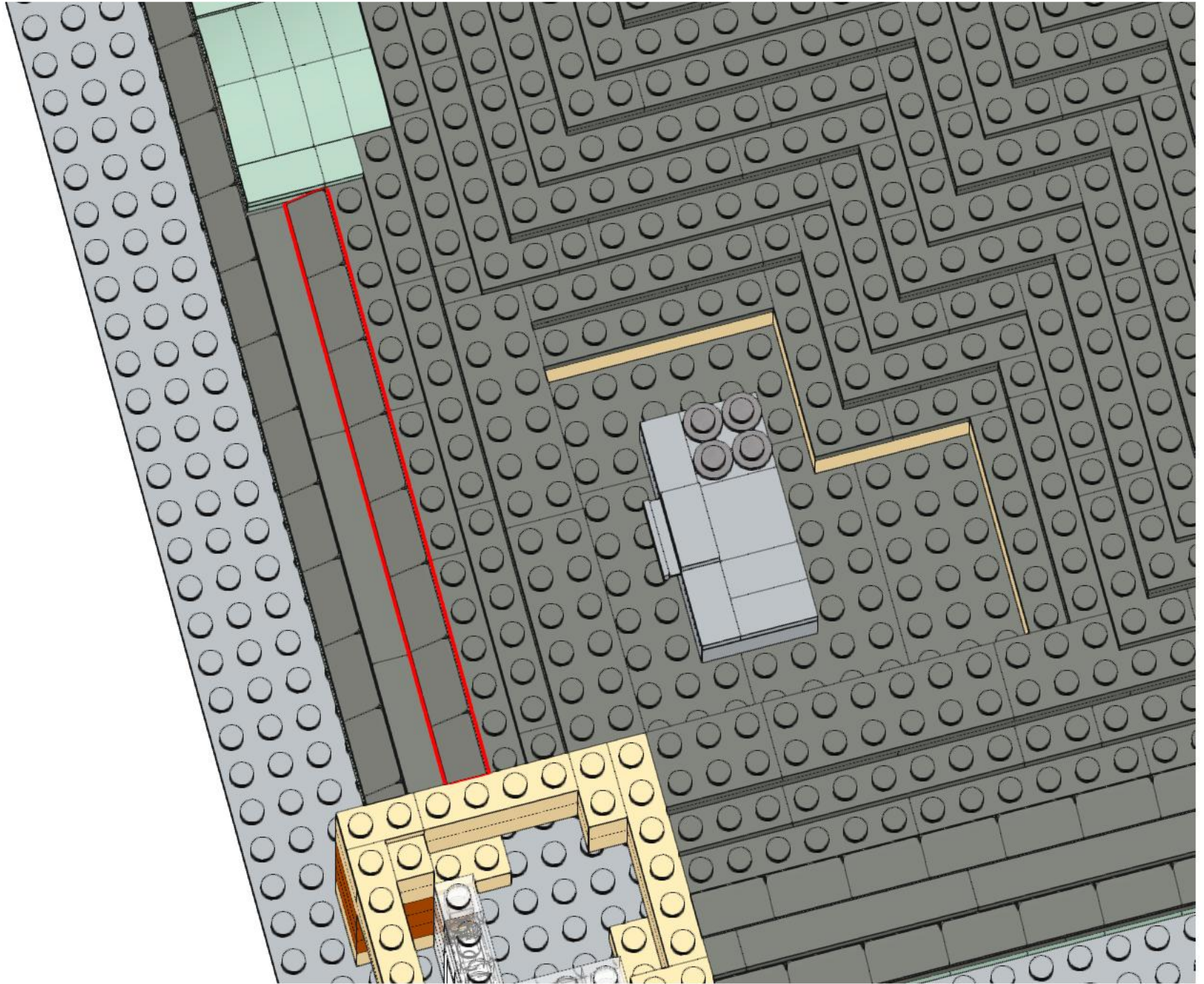
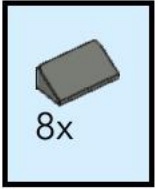

# 181

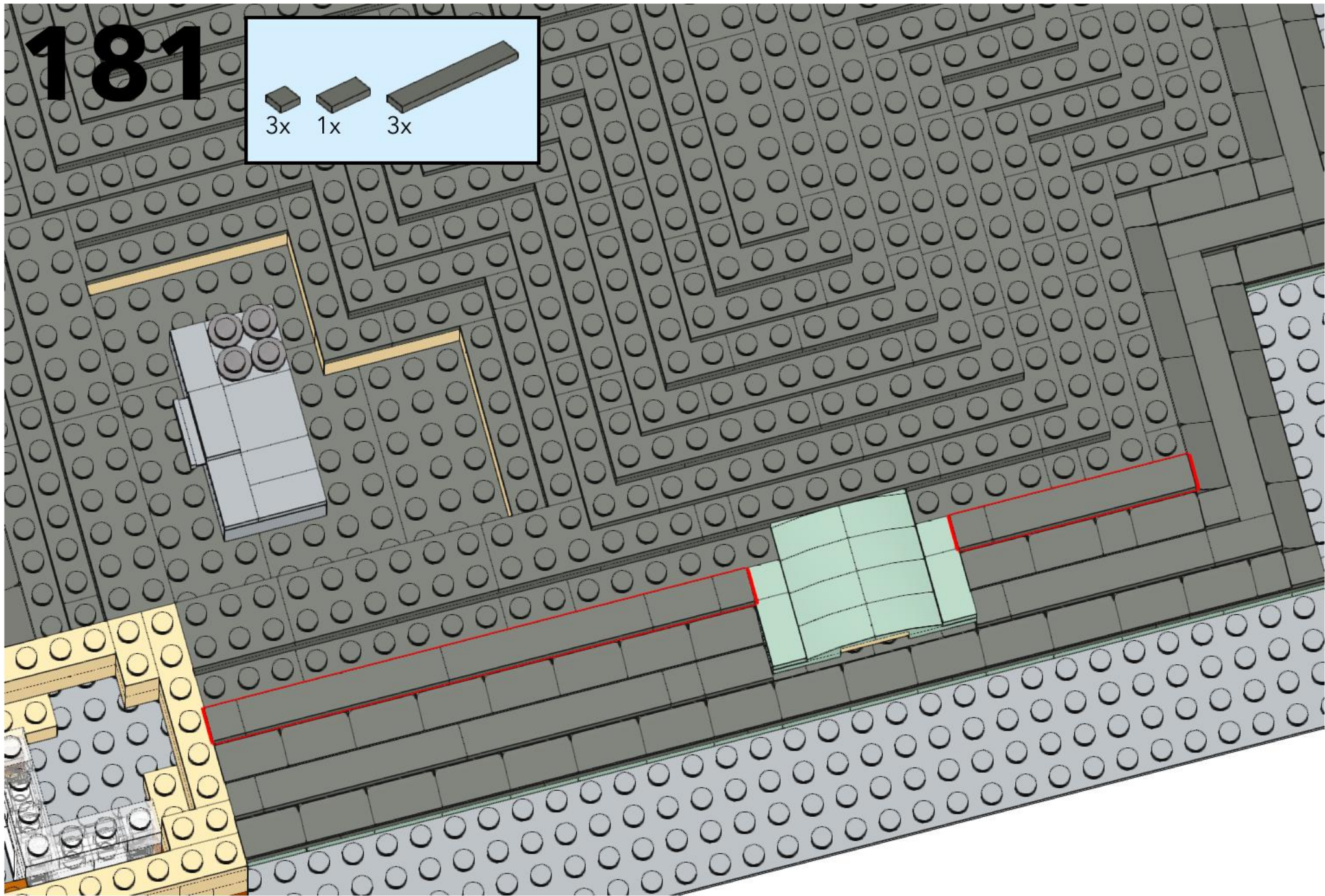
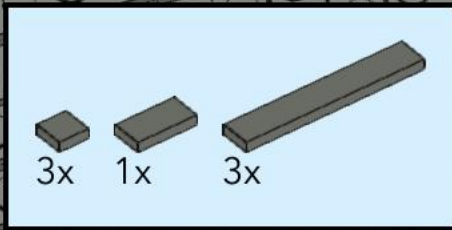

# 182

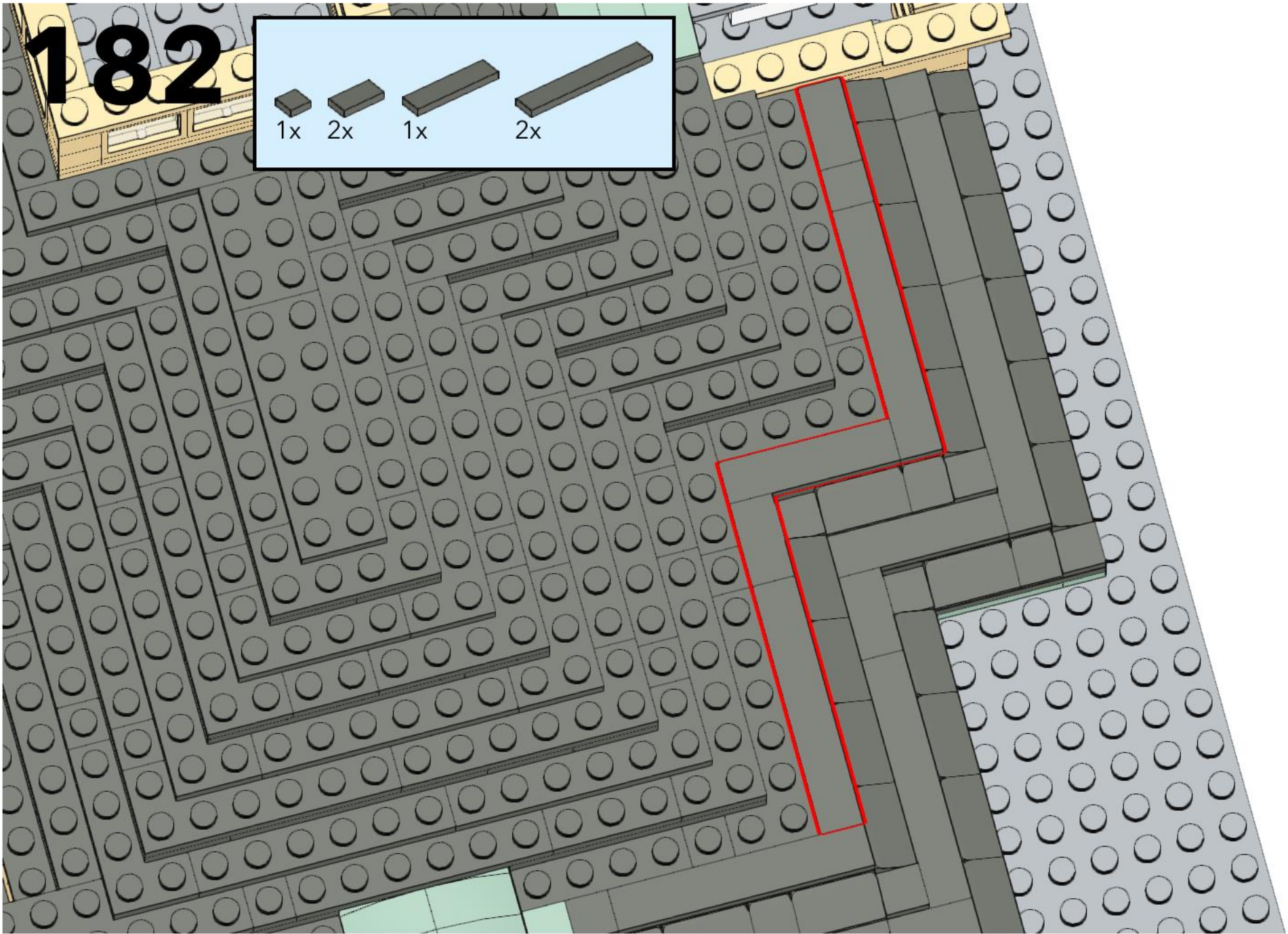
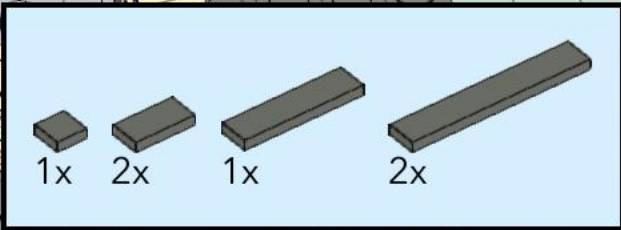

# 183

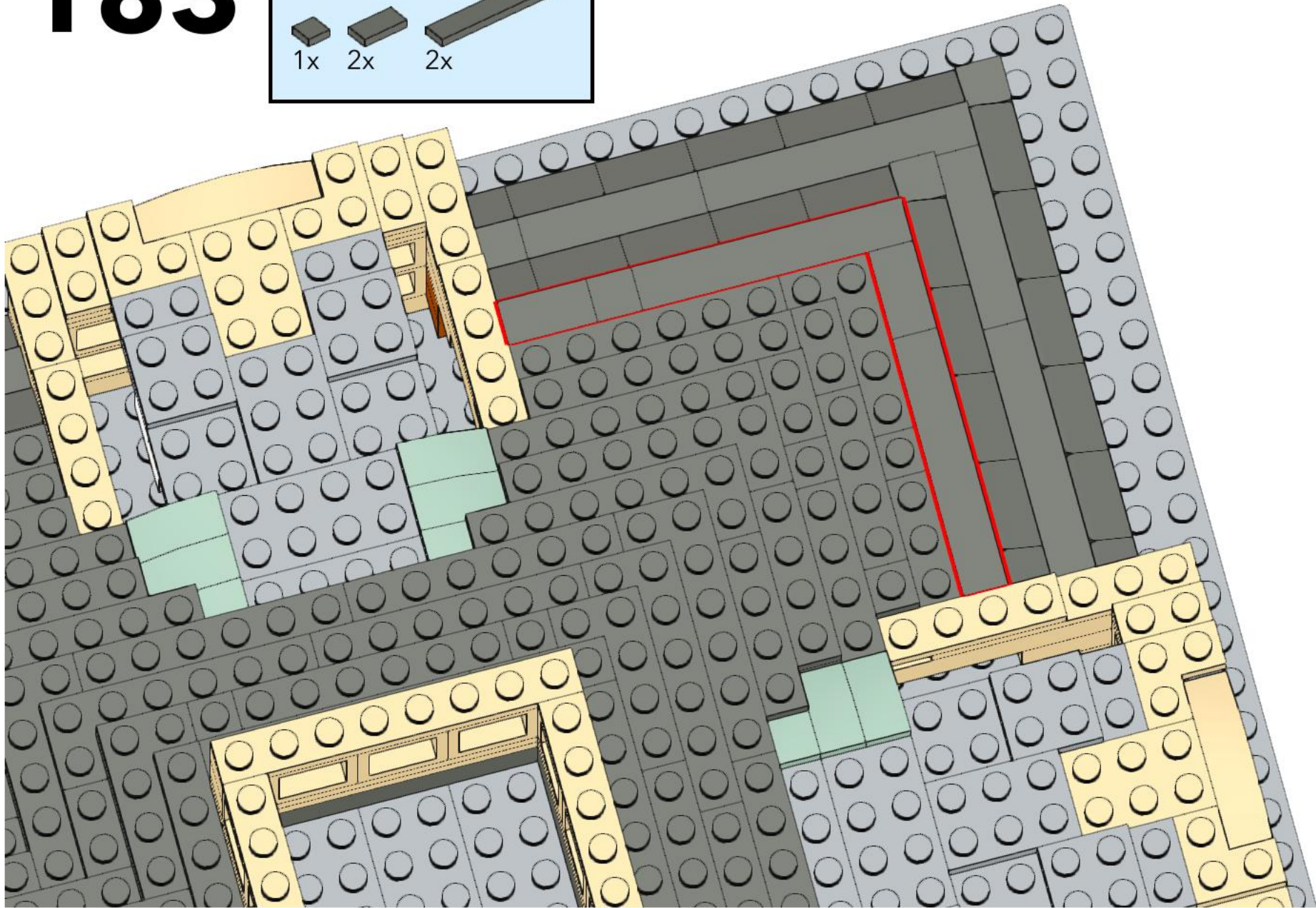
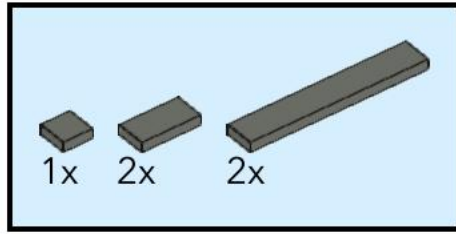



# 184

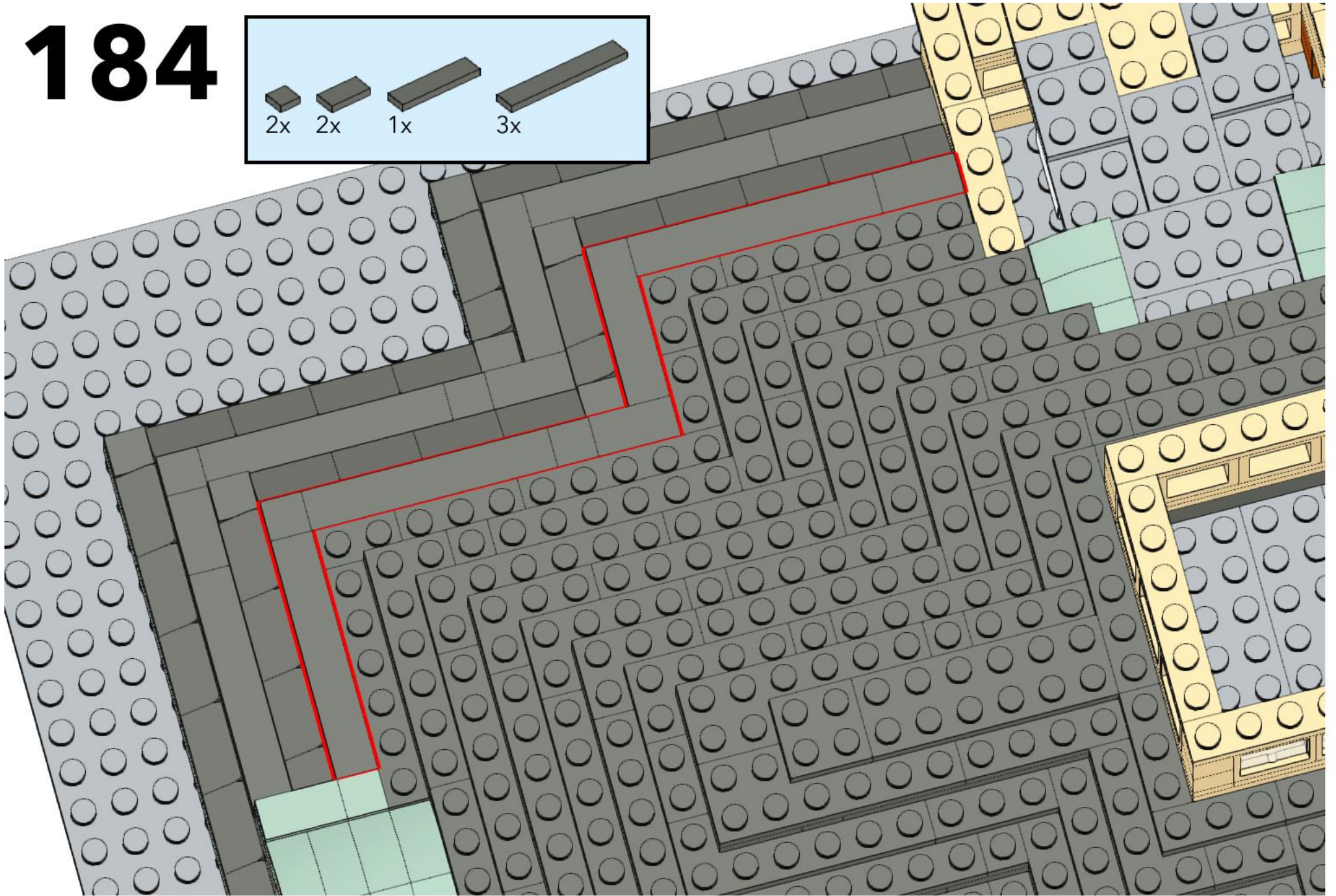
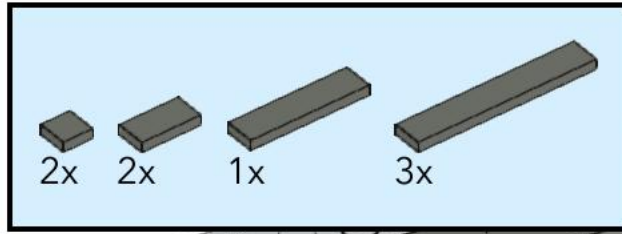

# 185

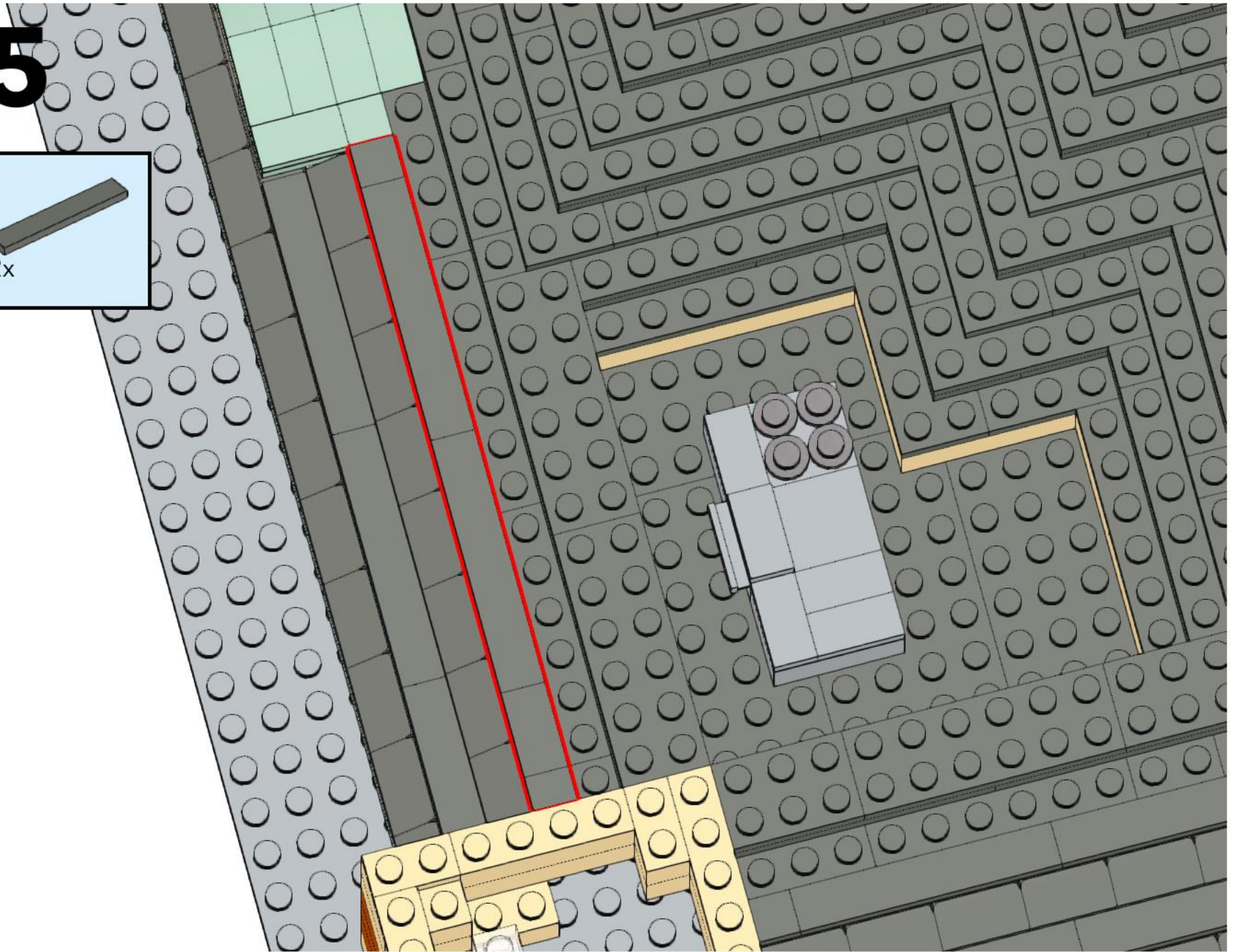
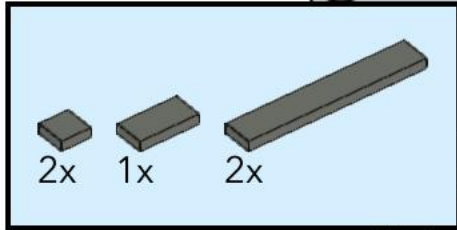

# 186

1x 1x 11x

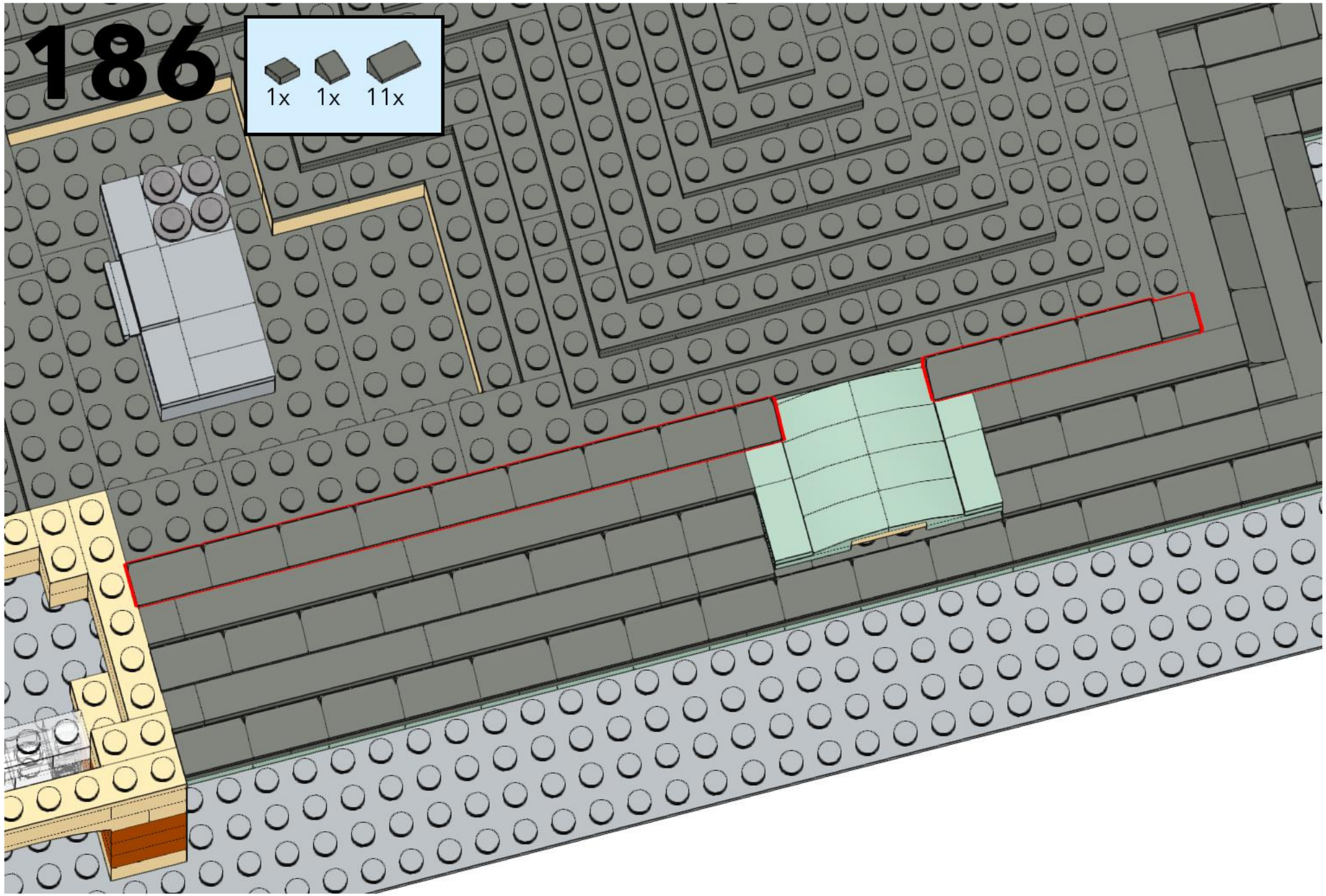

# 187

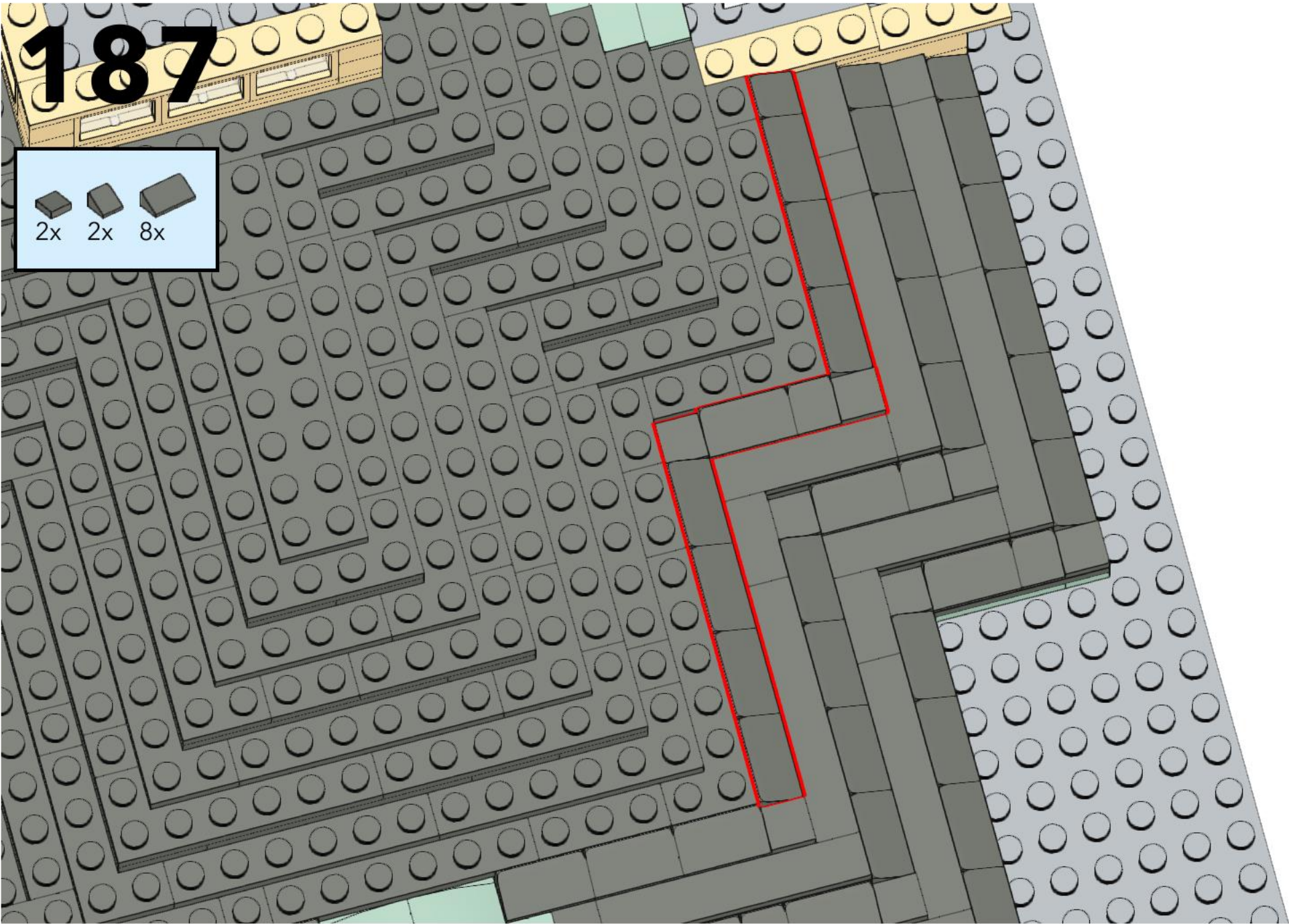
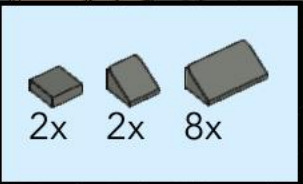

# 188

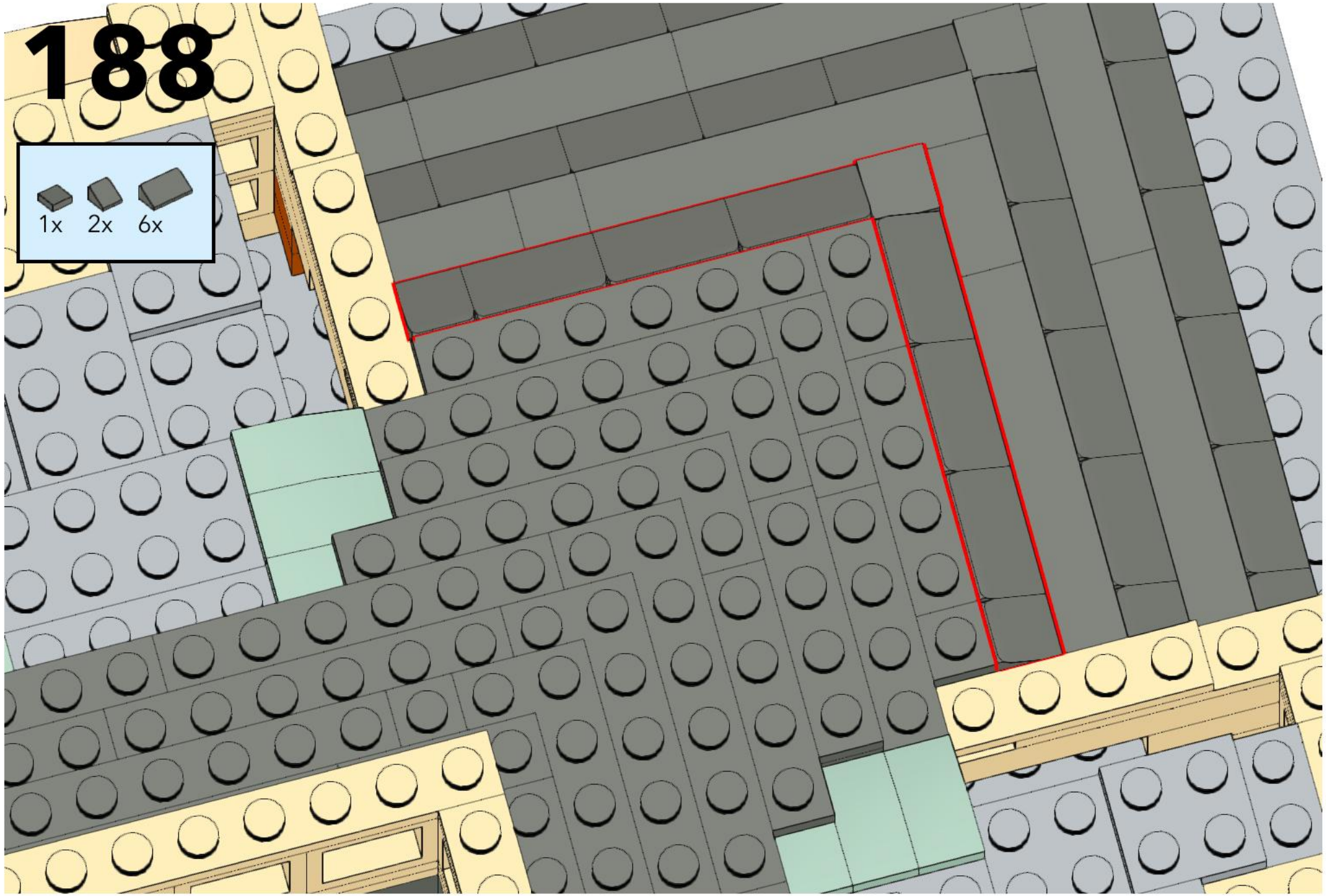

# 189

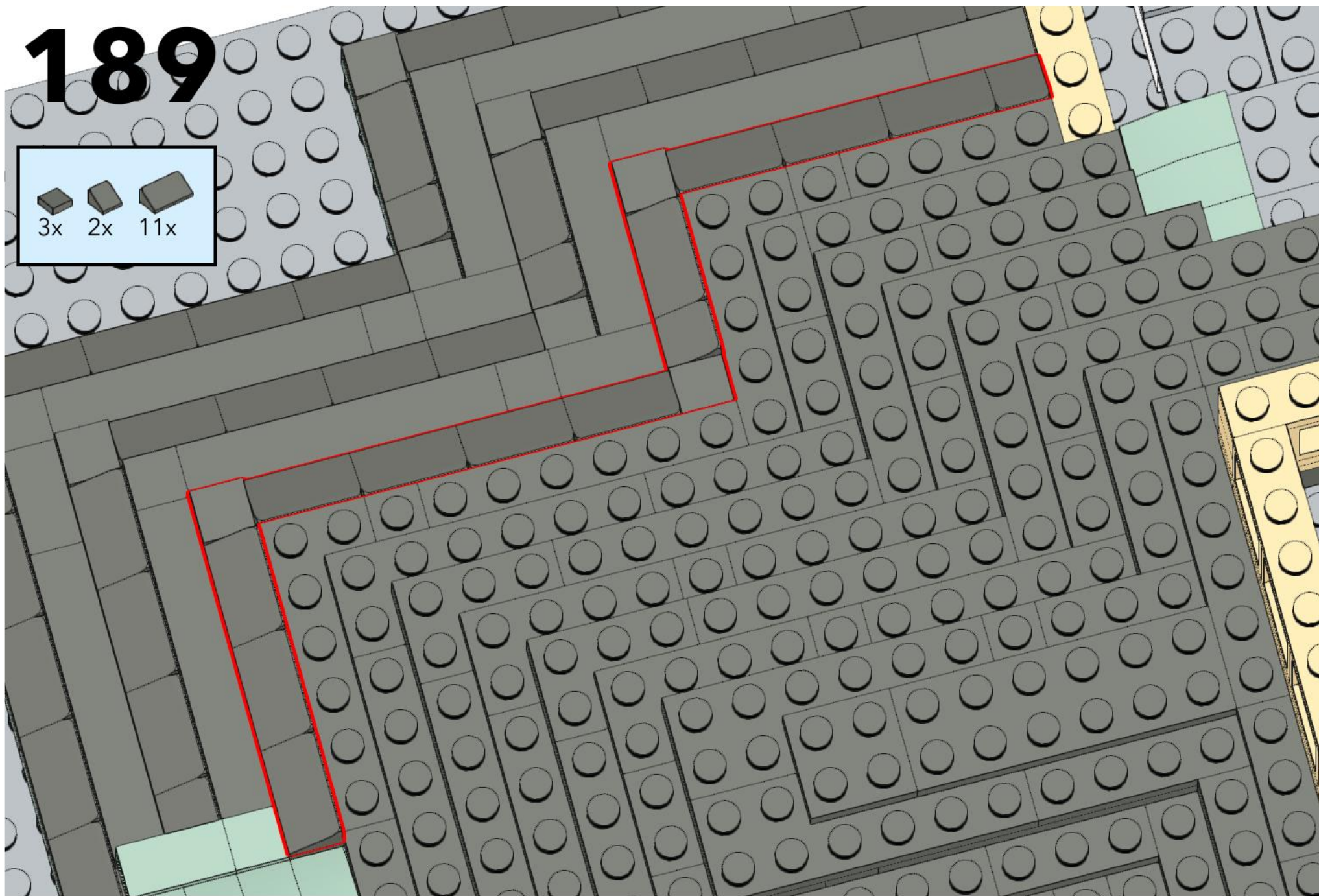
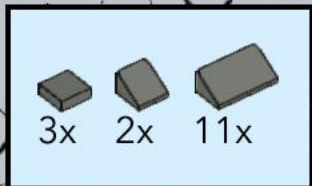

# 190

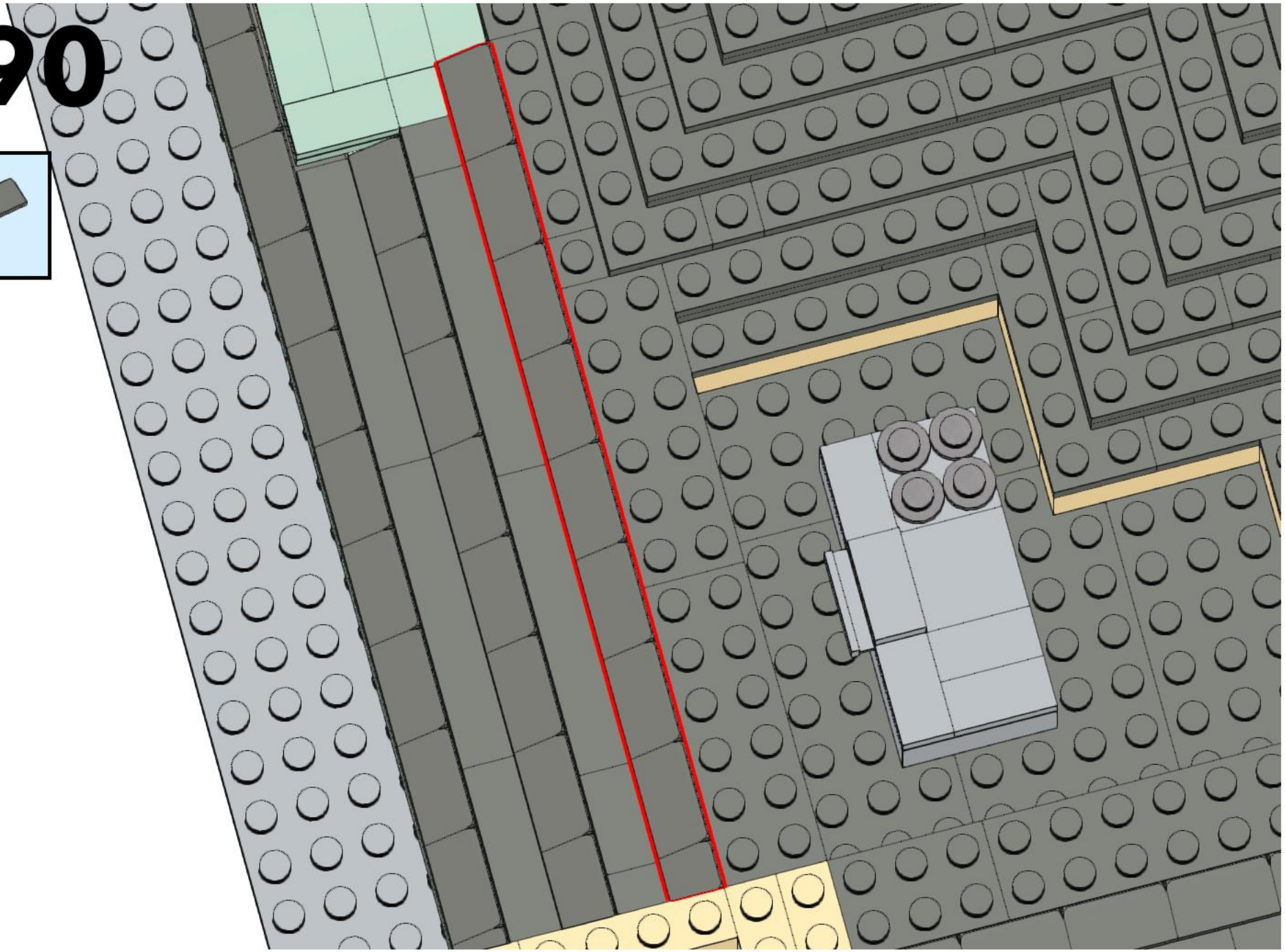
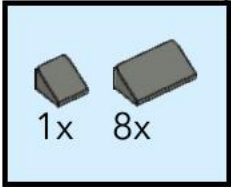

# 191

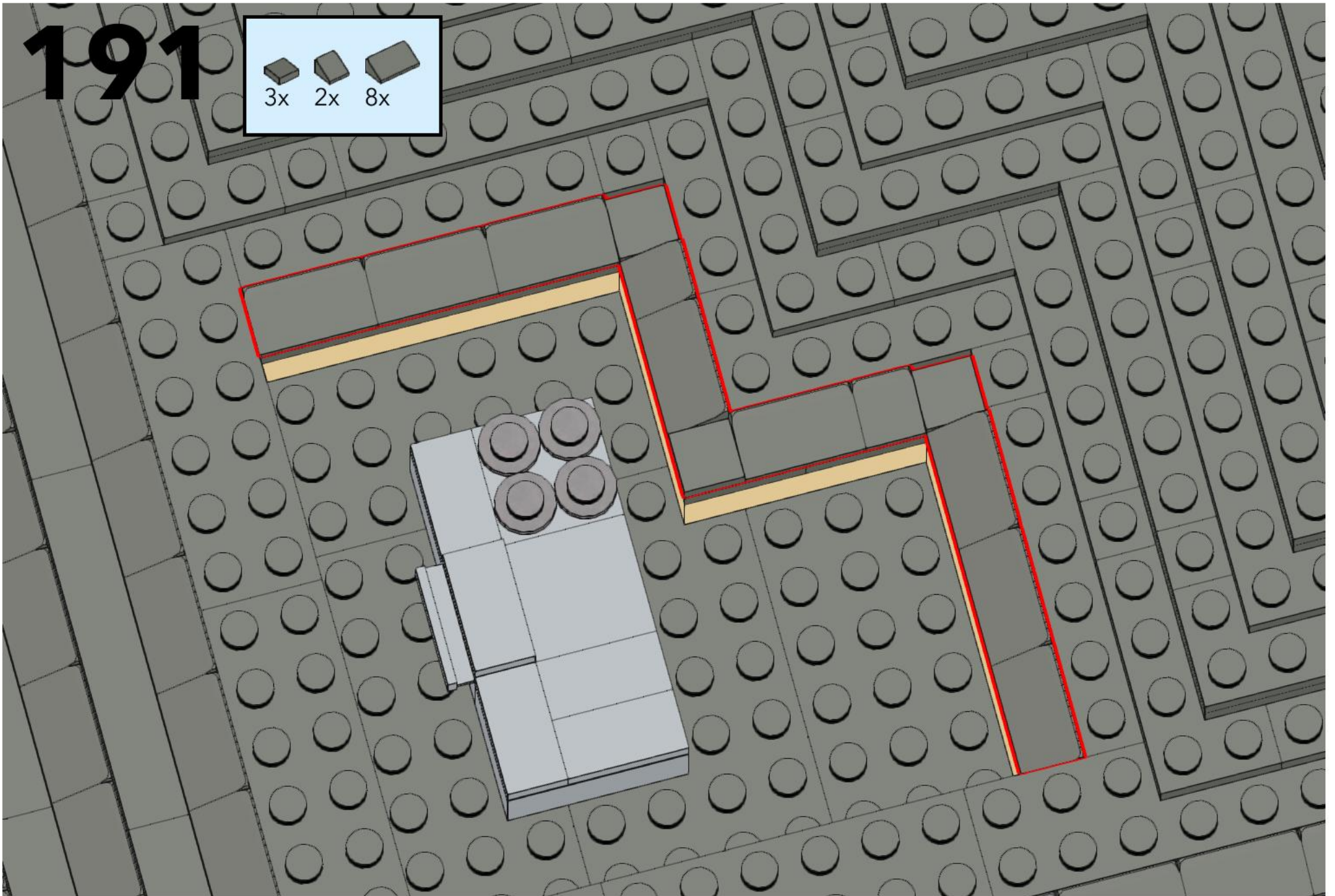
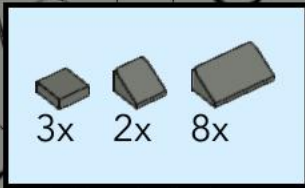



# 192

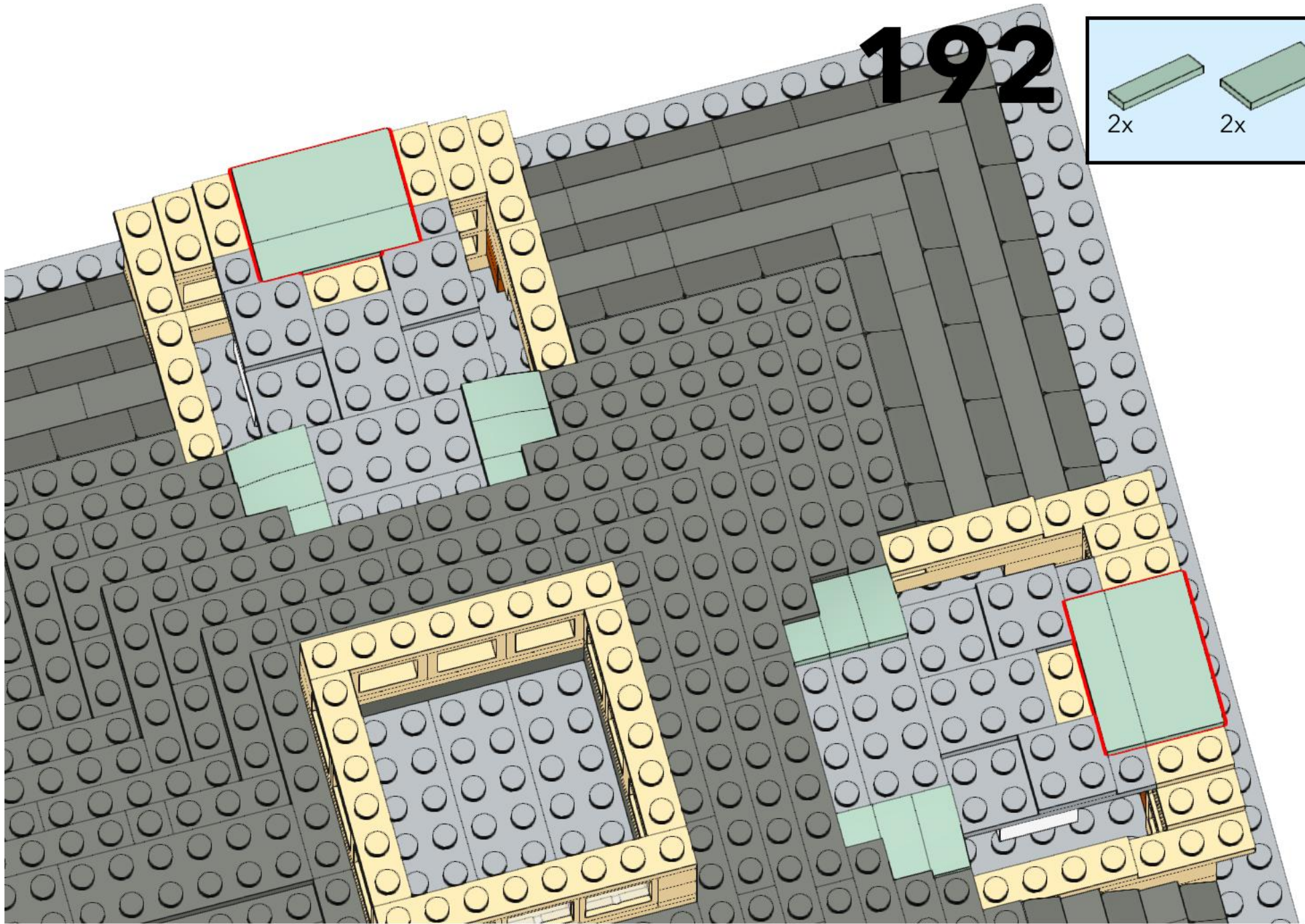
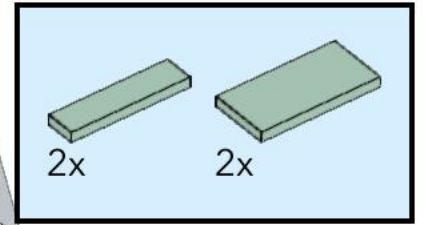

# 193

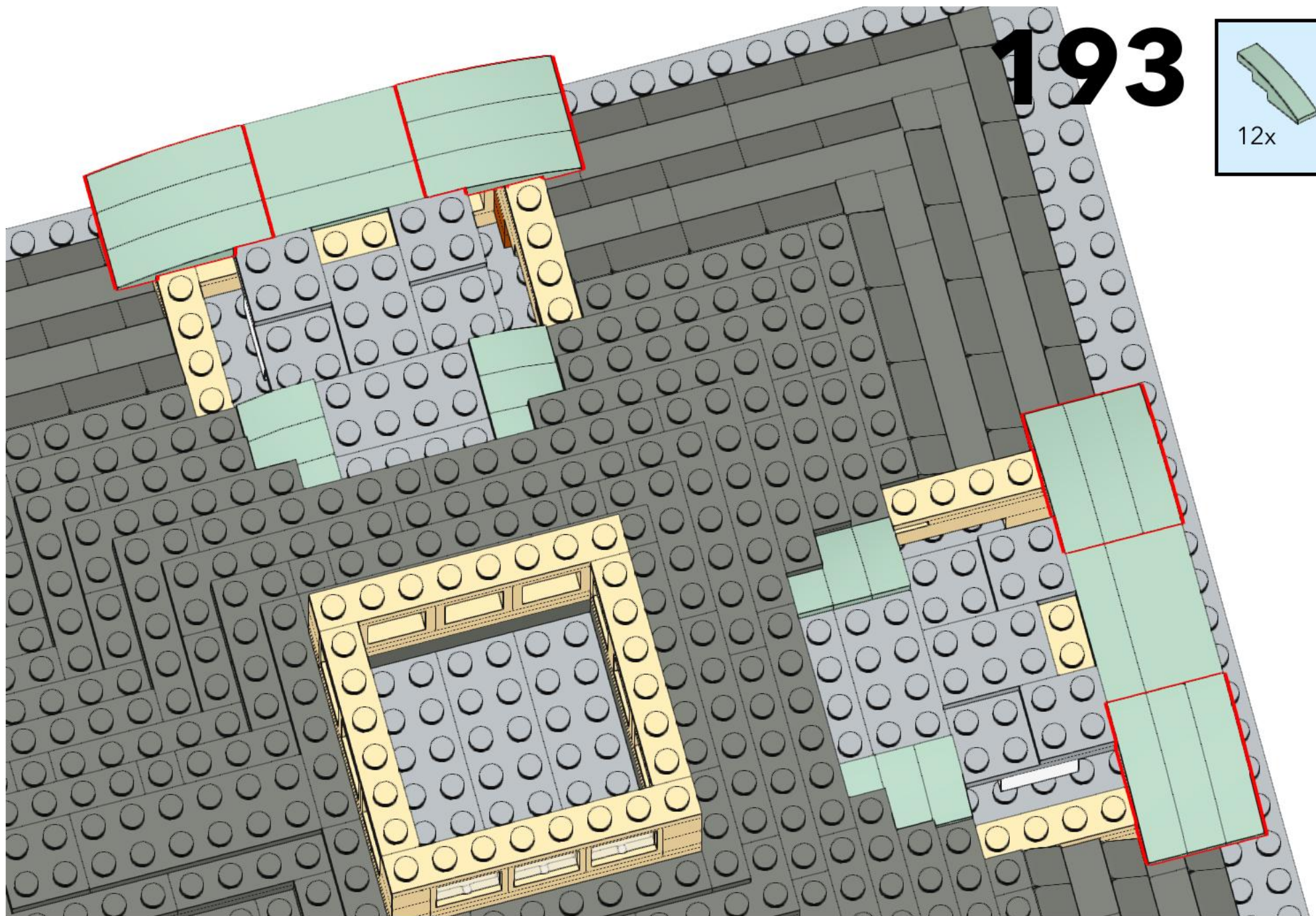
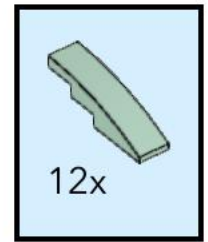

# 194

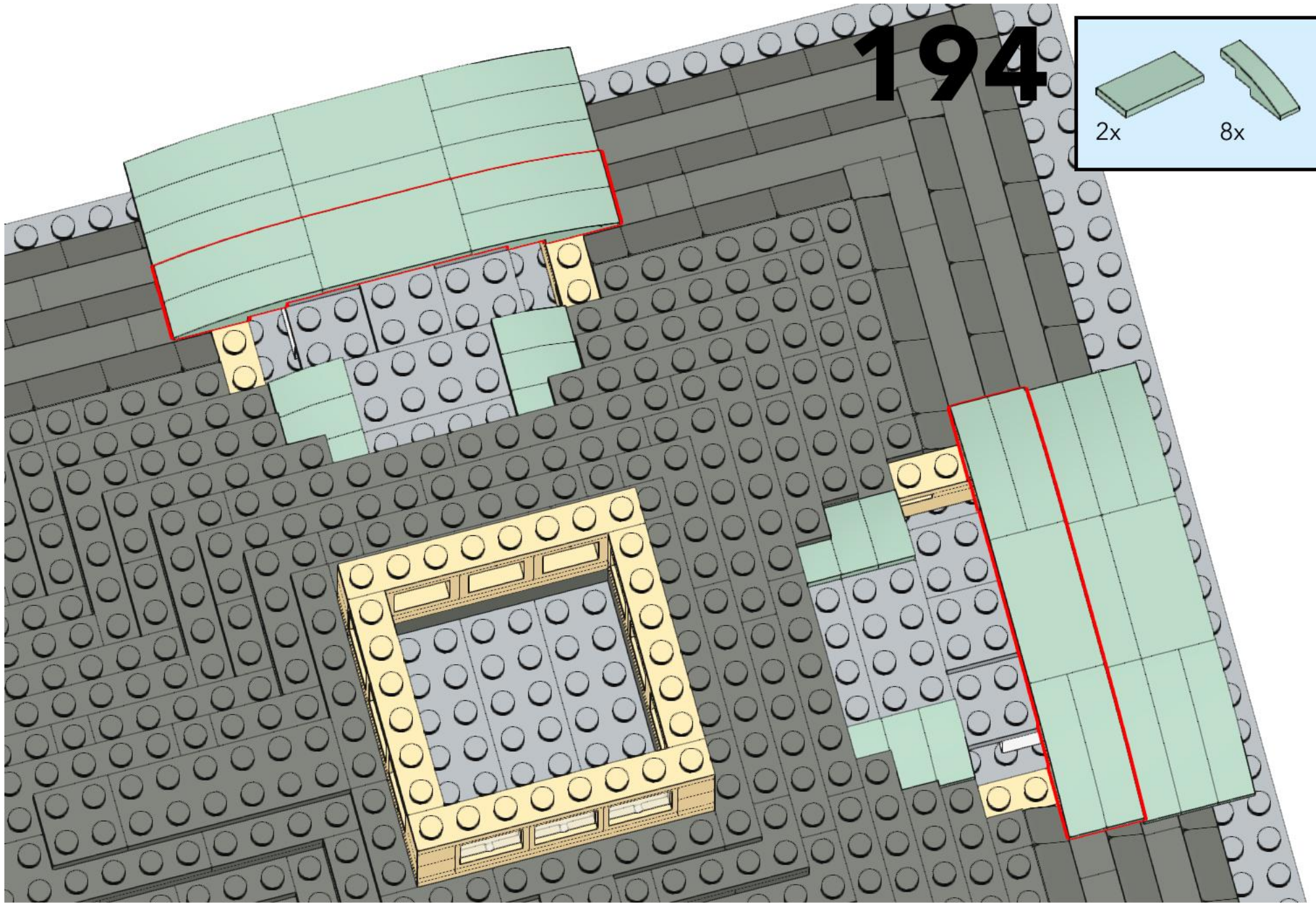
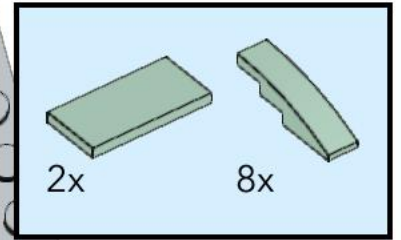

# 195

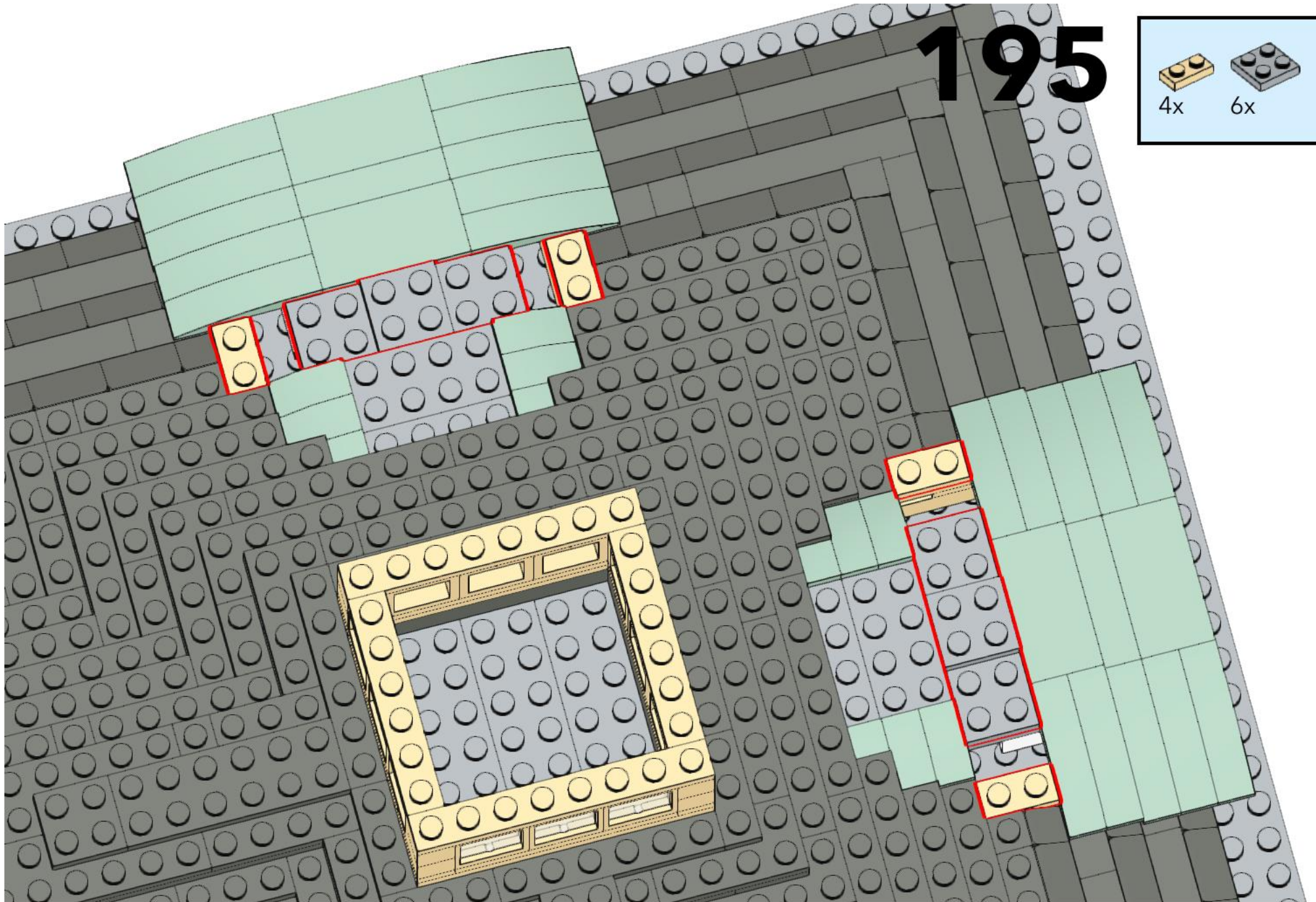
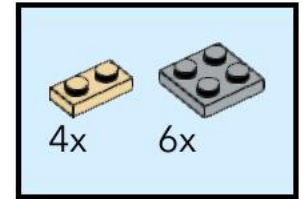

# 196

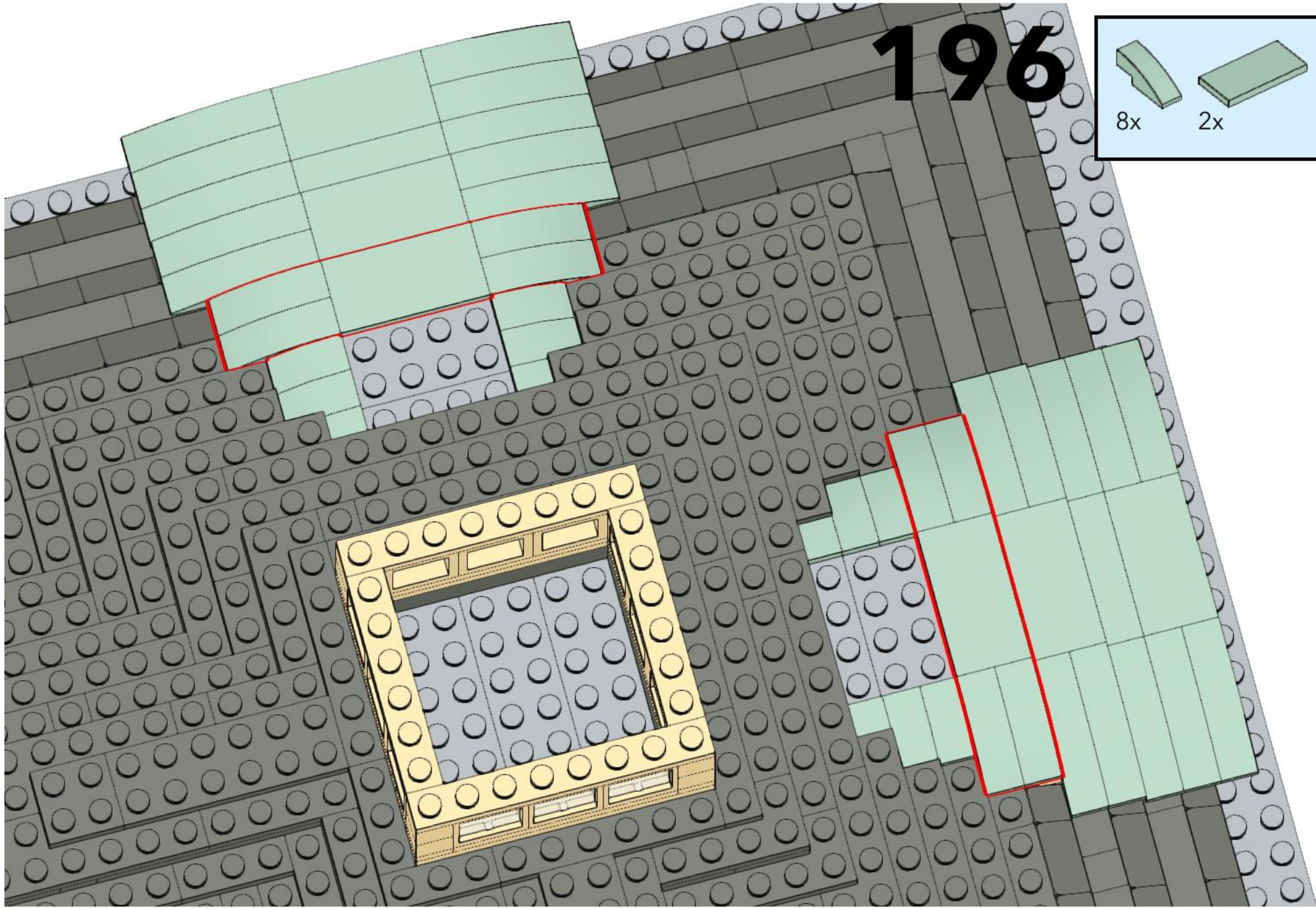
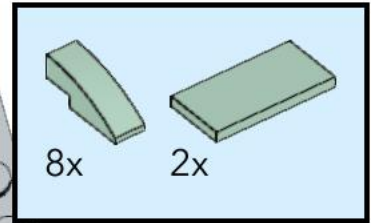

# 197

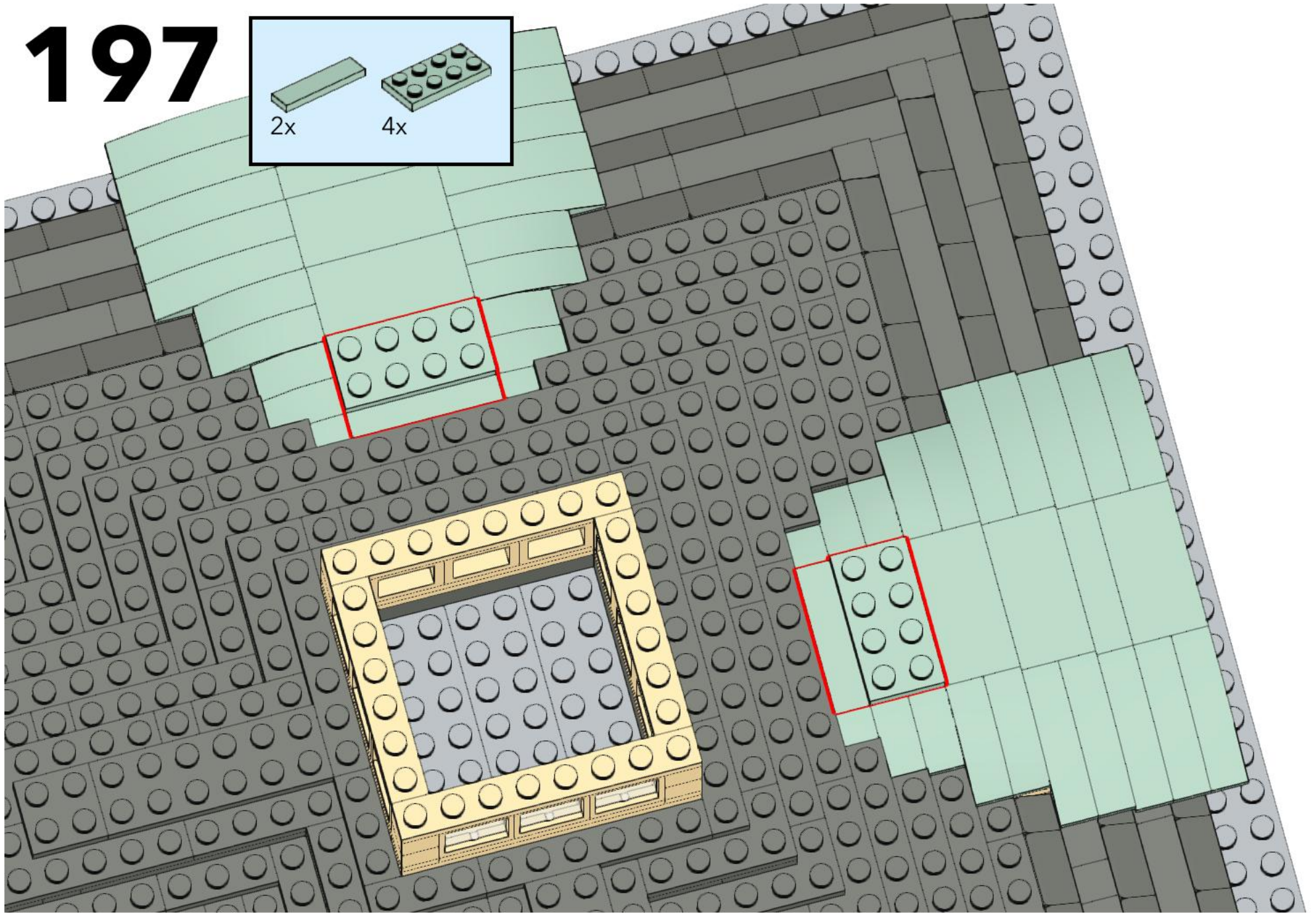
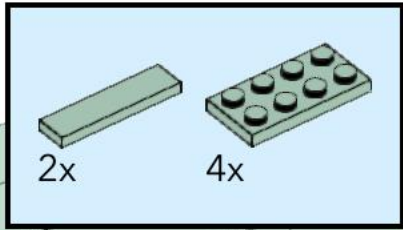

# 198

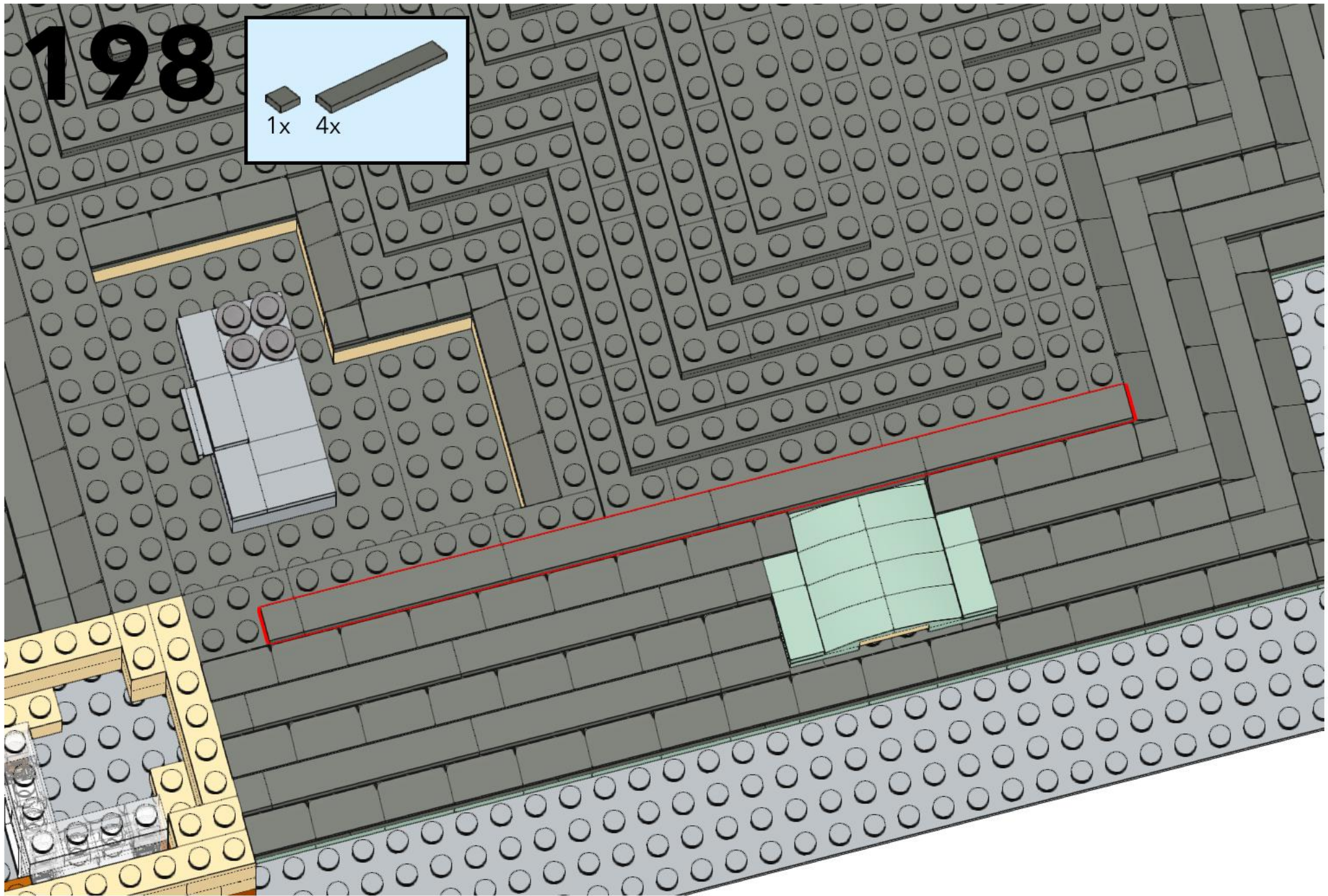
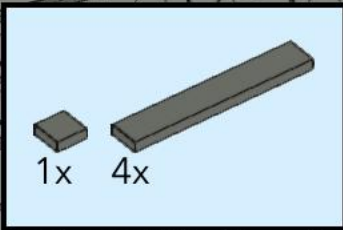

# 199

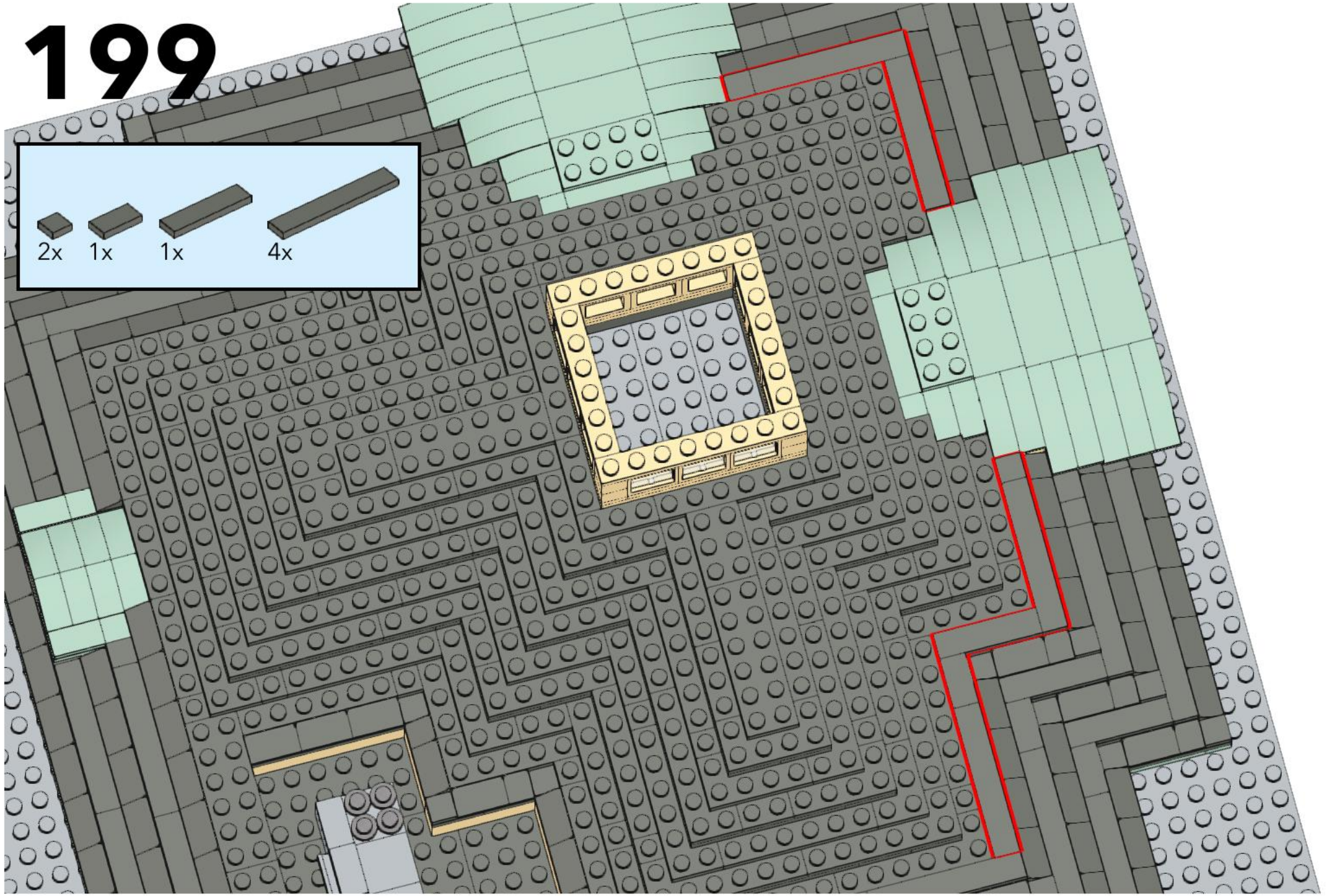
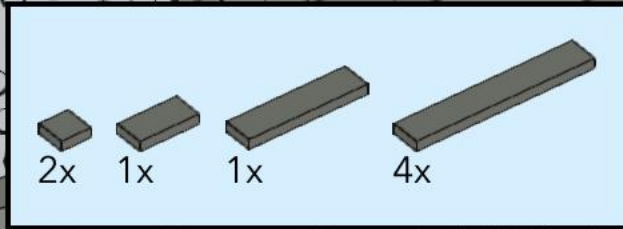



# 200

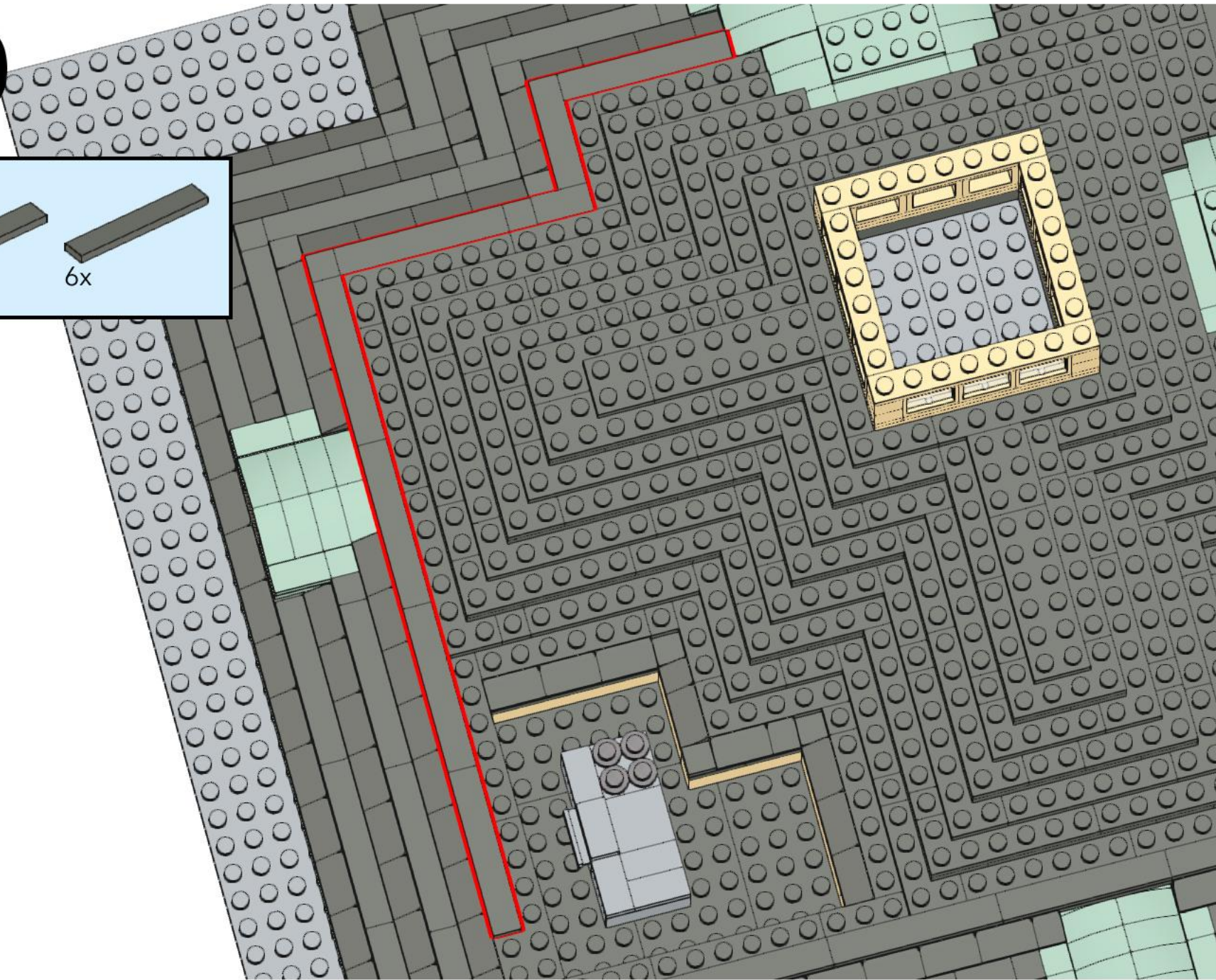
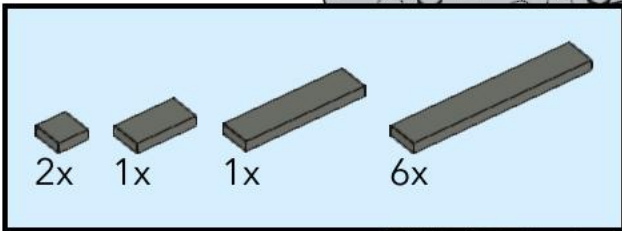

# 201

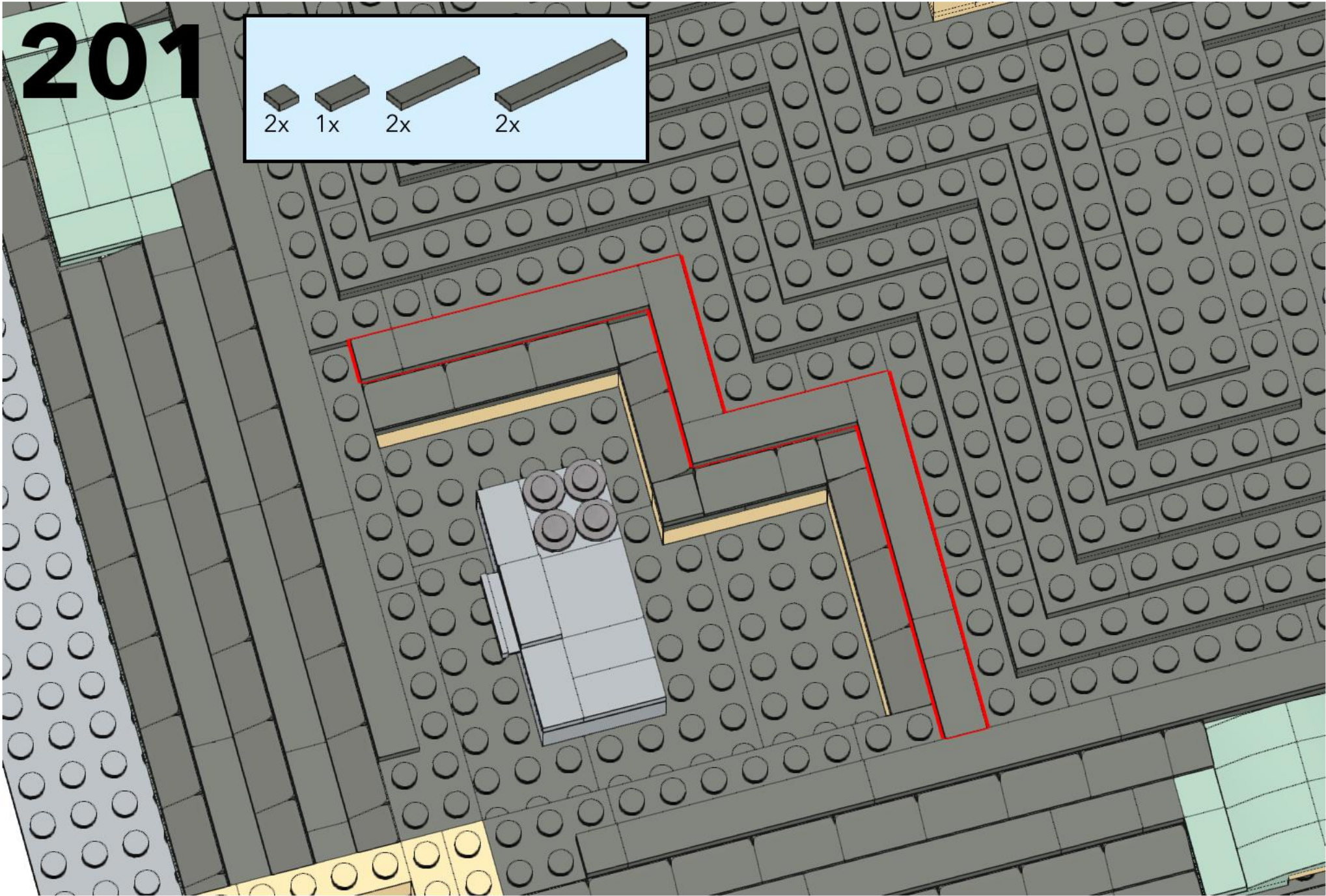
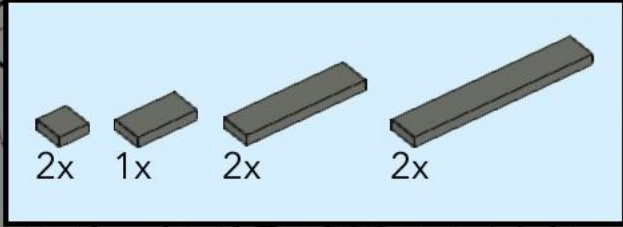

# 202

6x 2x 16x

A legend box with a light blue background and a black border. It contains three small grey LEGO Technic parts: a 1x2x2 brick, a 1x2x1 brick, and a 1x6x2 brick. Below each part is its corresponding label: '6x', '2x', and '16x'.

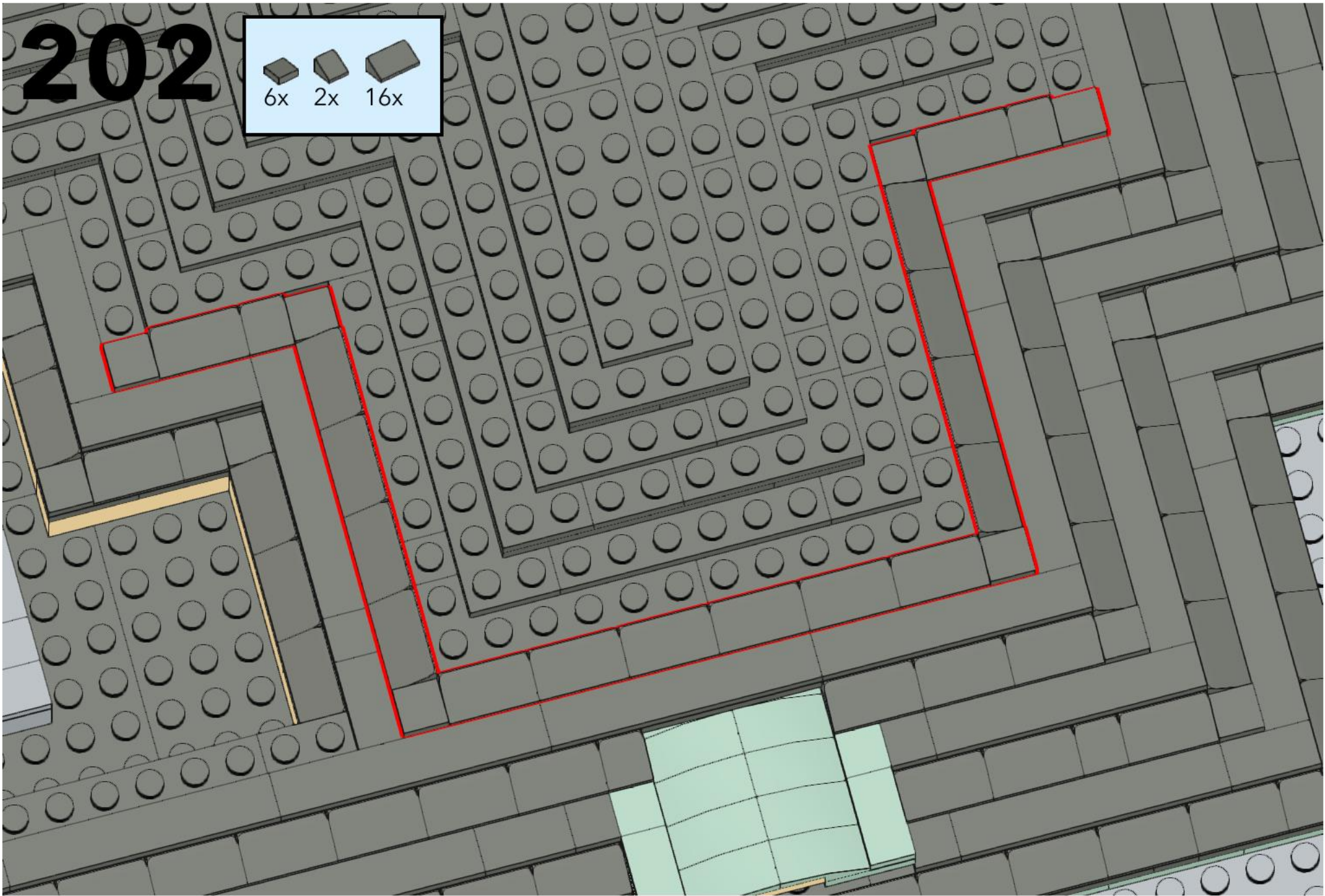

# 203

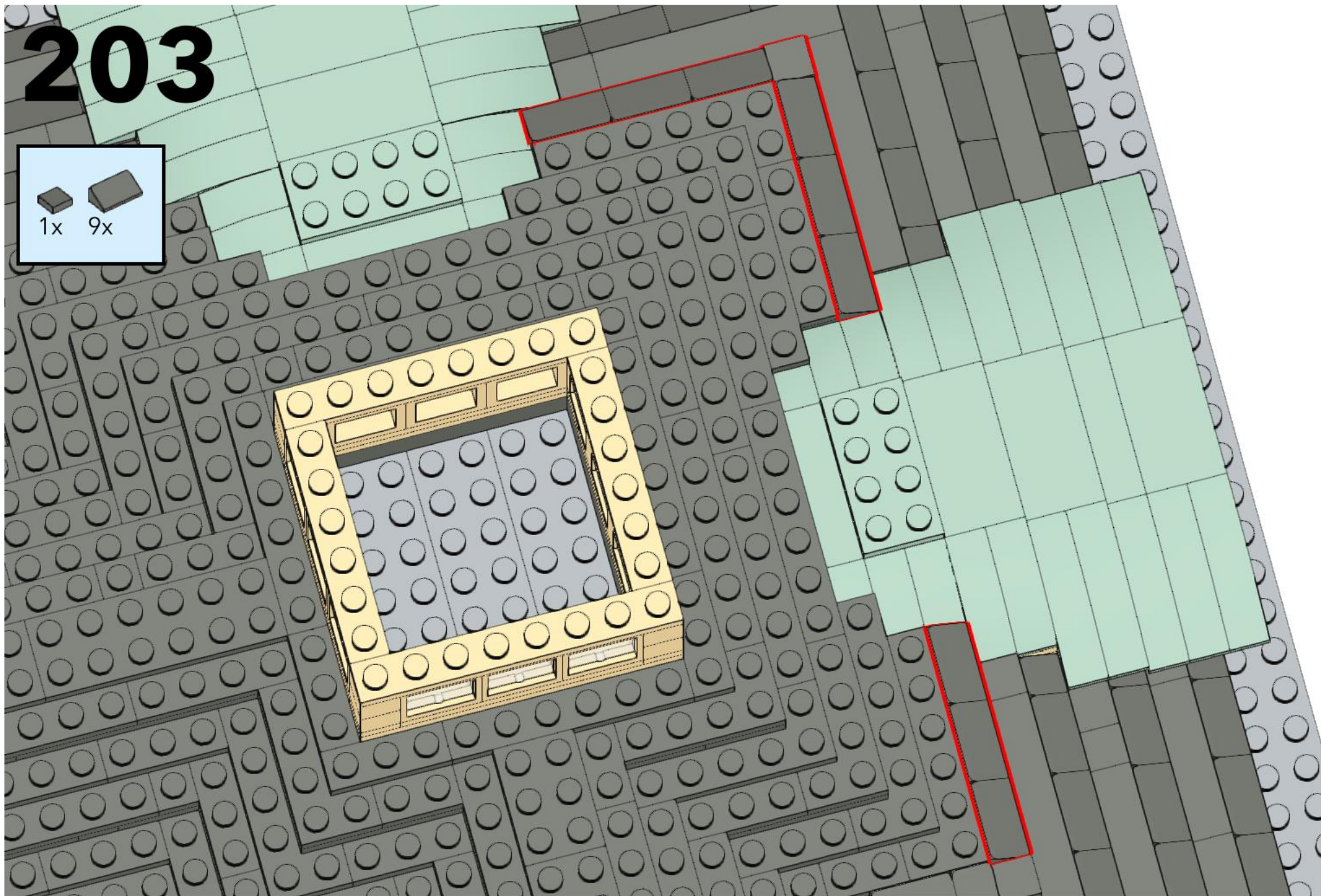

# 204

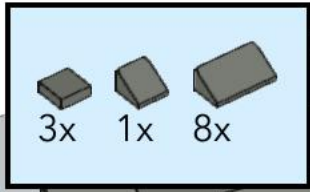

3x 1x 8x

This block contains a parts list for step 204. It features three small grey 1x1 Technic bricks with different hole patterns: a 1-hole brick, a 2-hole brick, and a 3-hole brick. Below each brick icon is its respective quantity: '3x' for the 1-hole brick, '1x' for the 2-hole brick, and '8x' for the 3-hole brick.

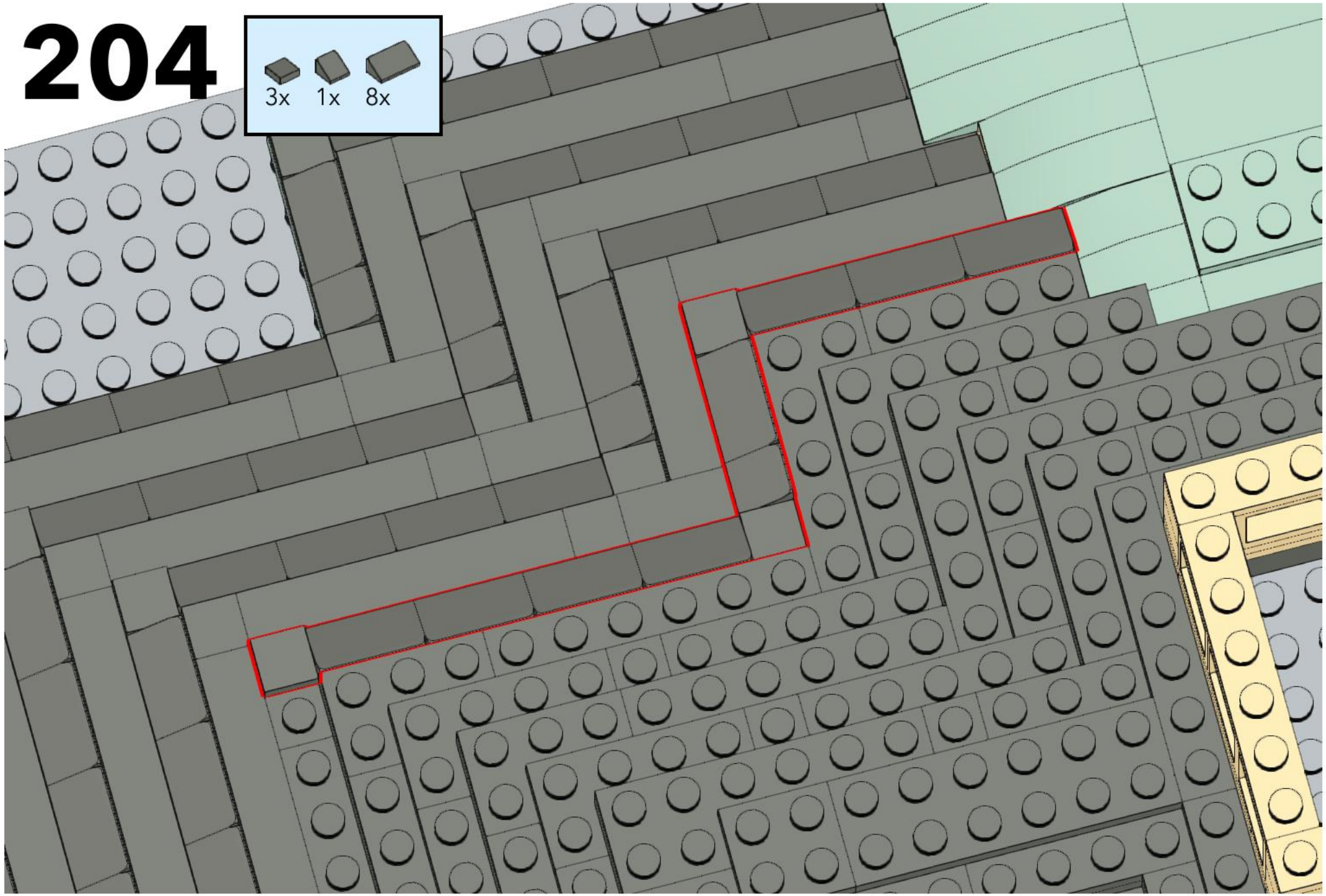

# 205

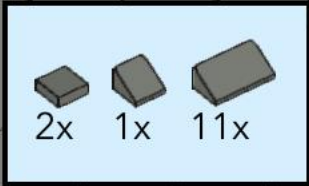

2x 1x 11x

The legend shows three types of grey building blocks: a 2x1 block, a 1x1 block, and a 1x11 block. Below each block is its respective quantity: 2x, 1x, and 11x.

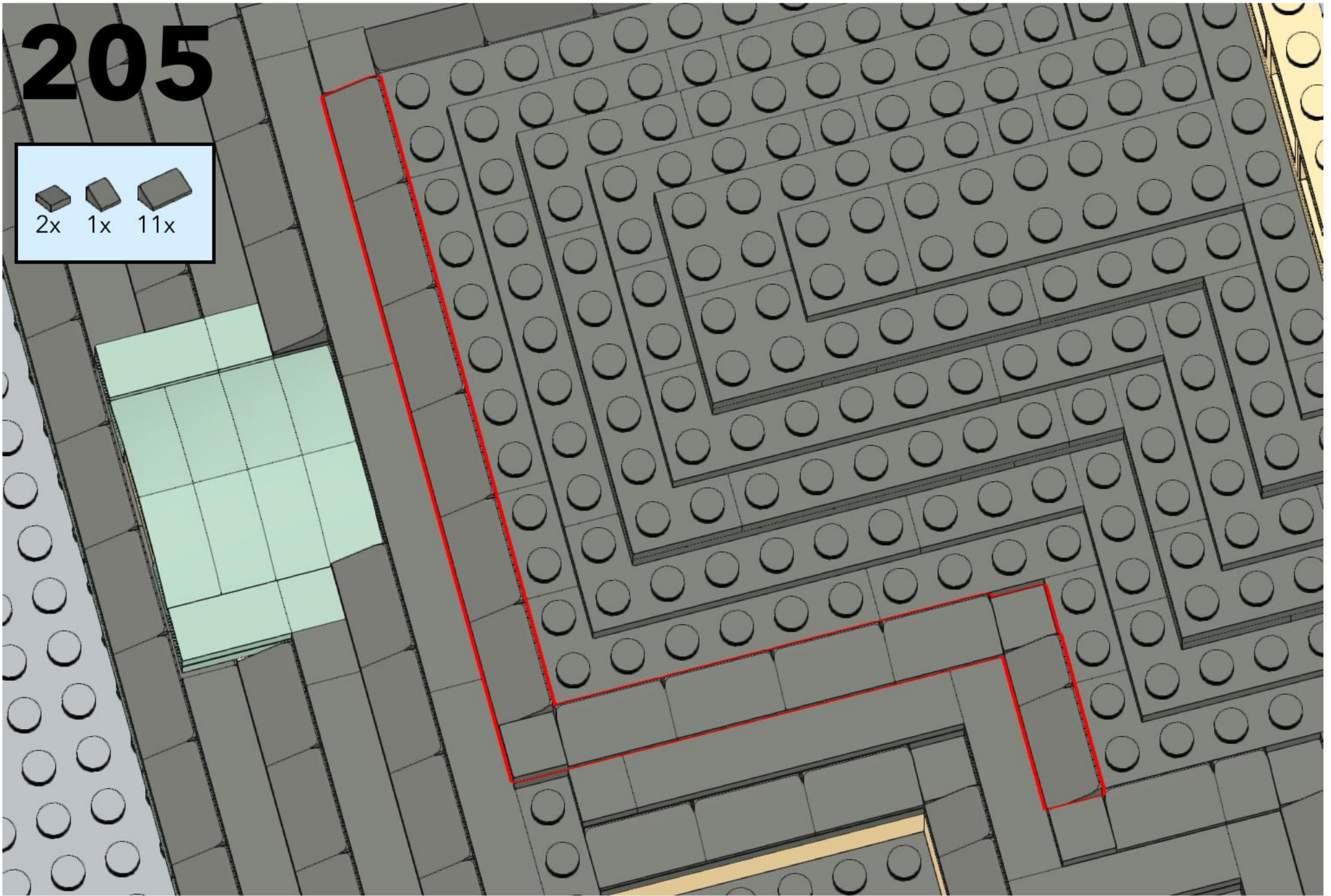

# 206

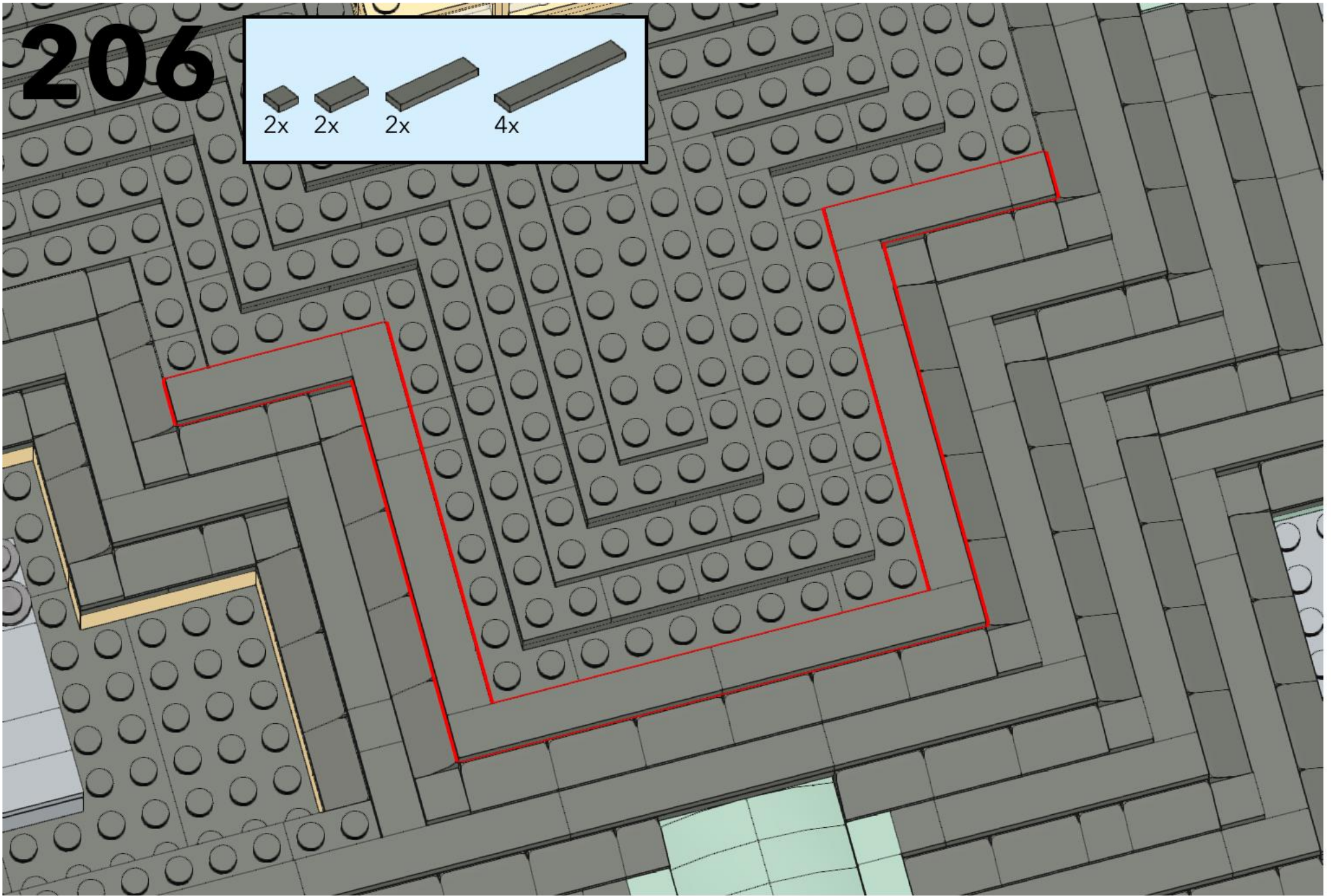
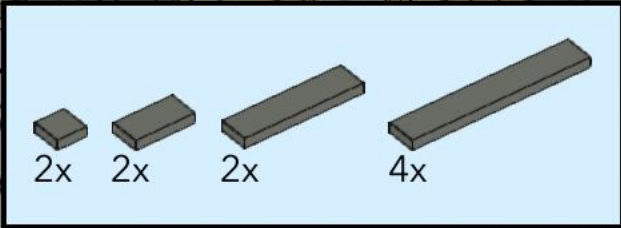

# 207

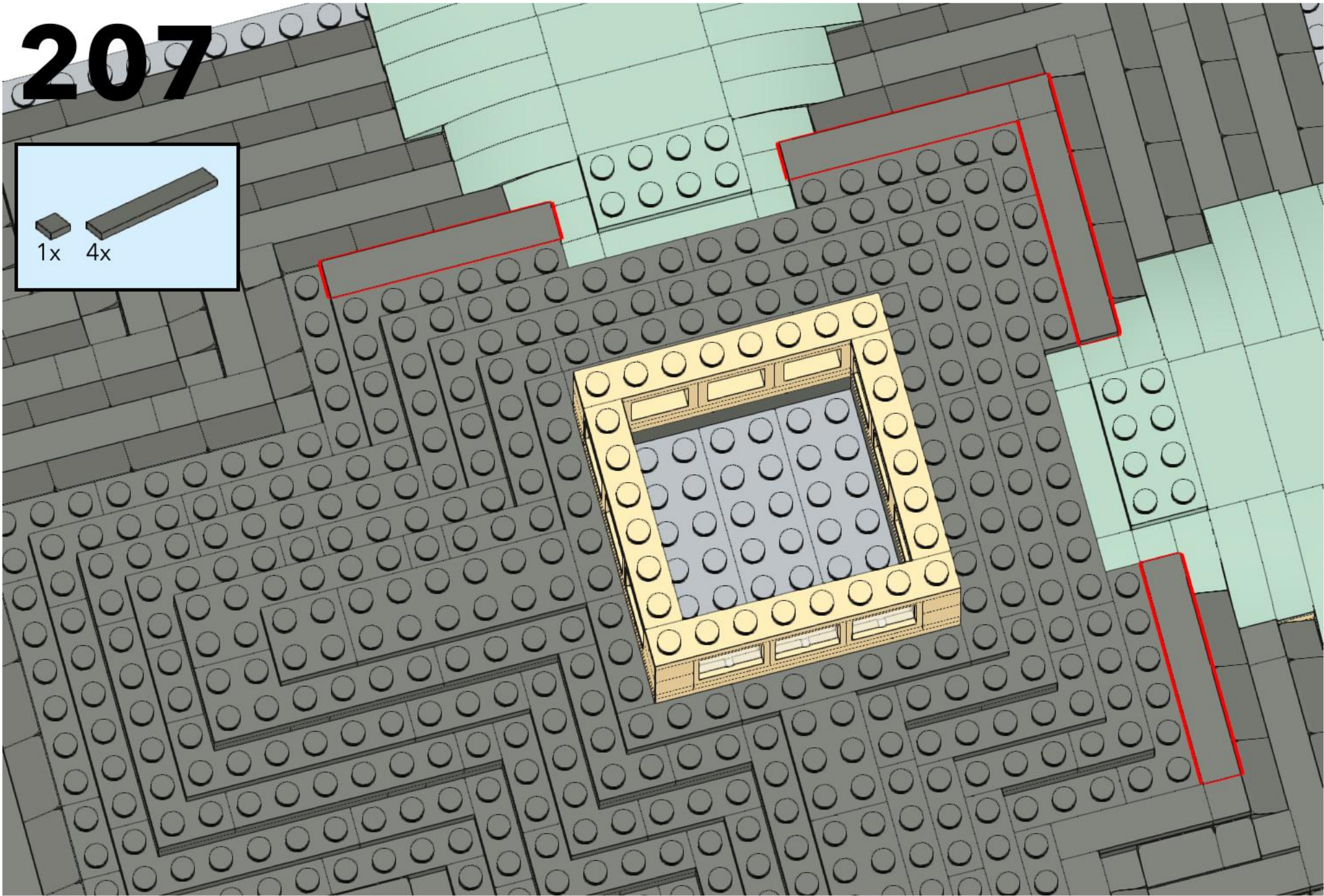
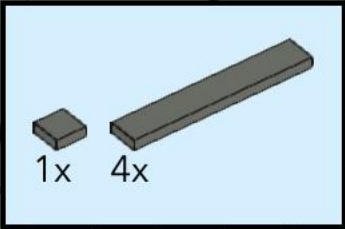



# 208

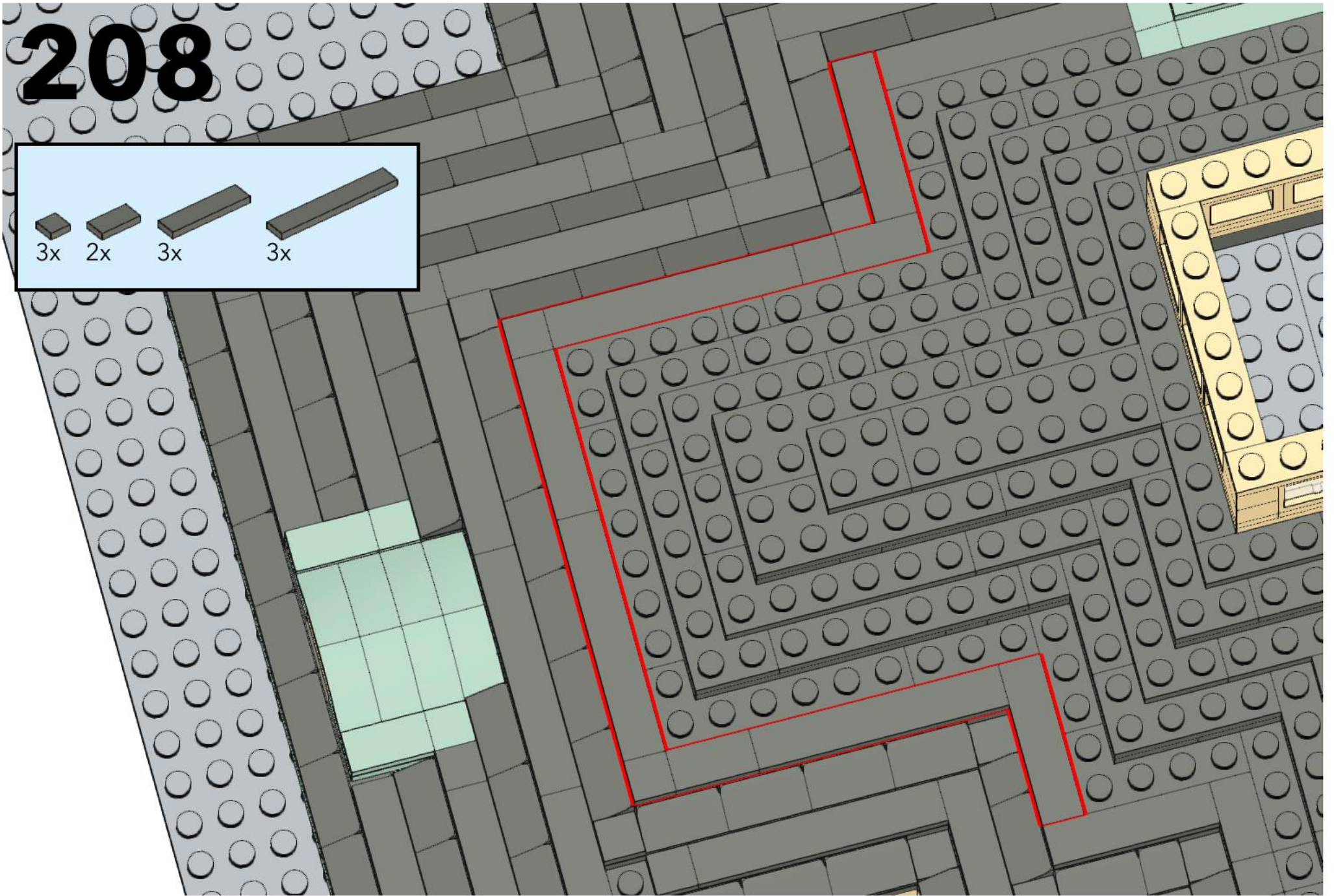
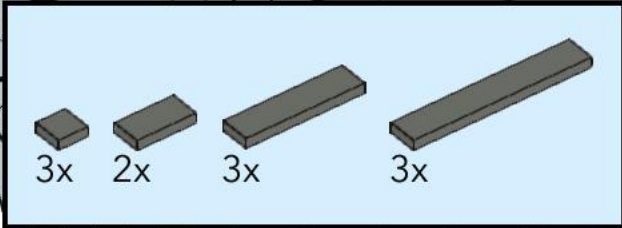

# 209

6x 2x 14x

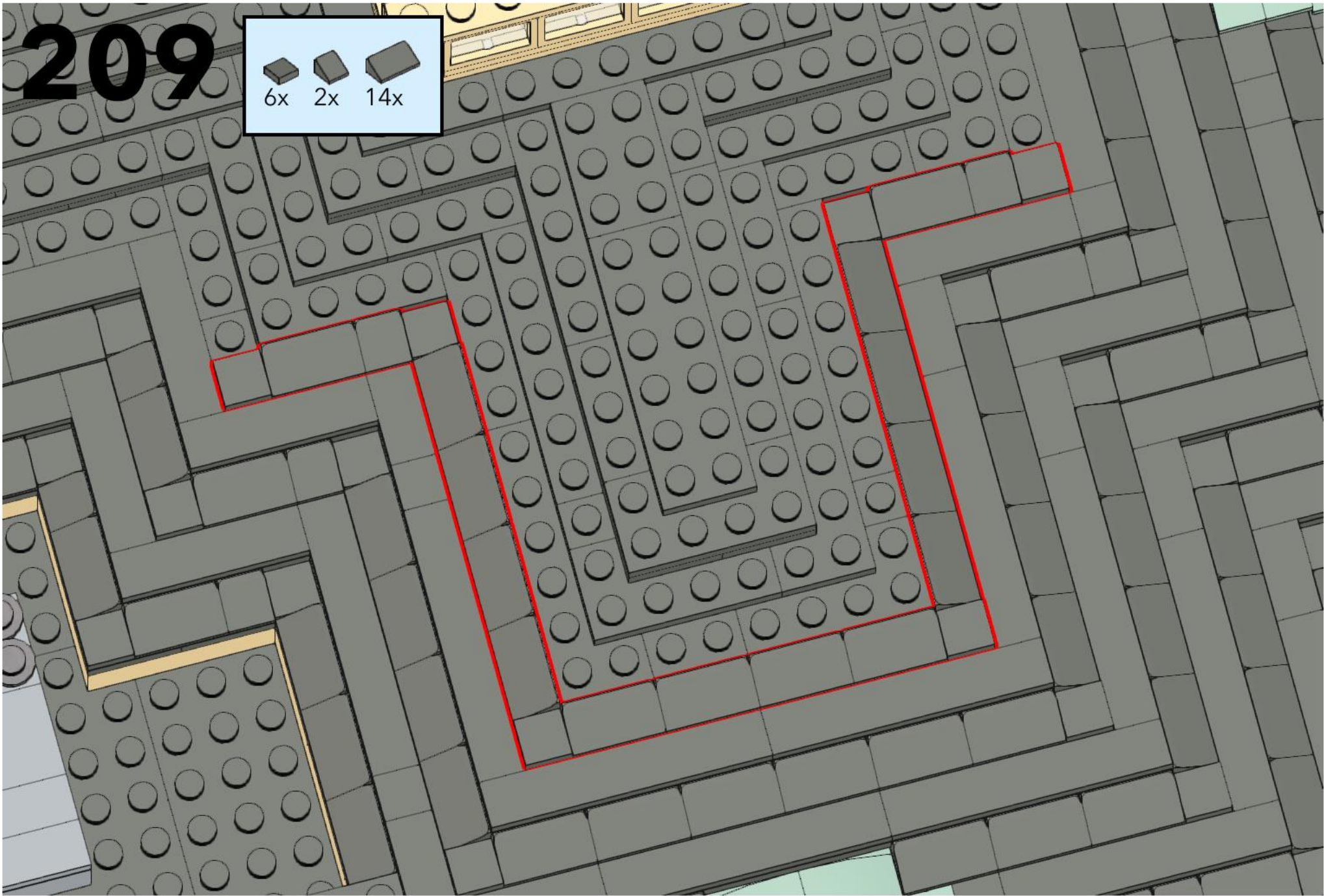

# 210

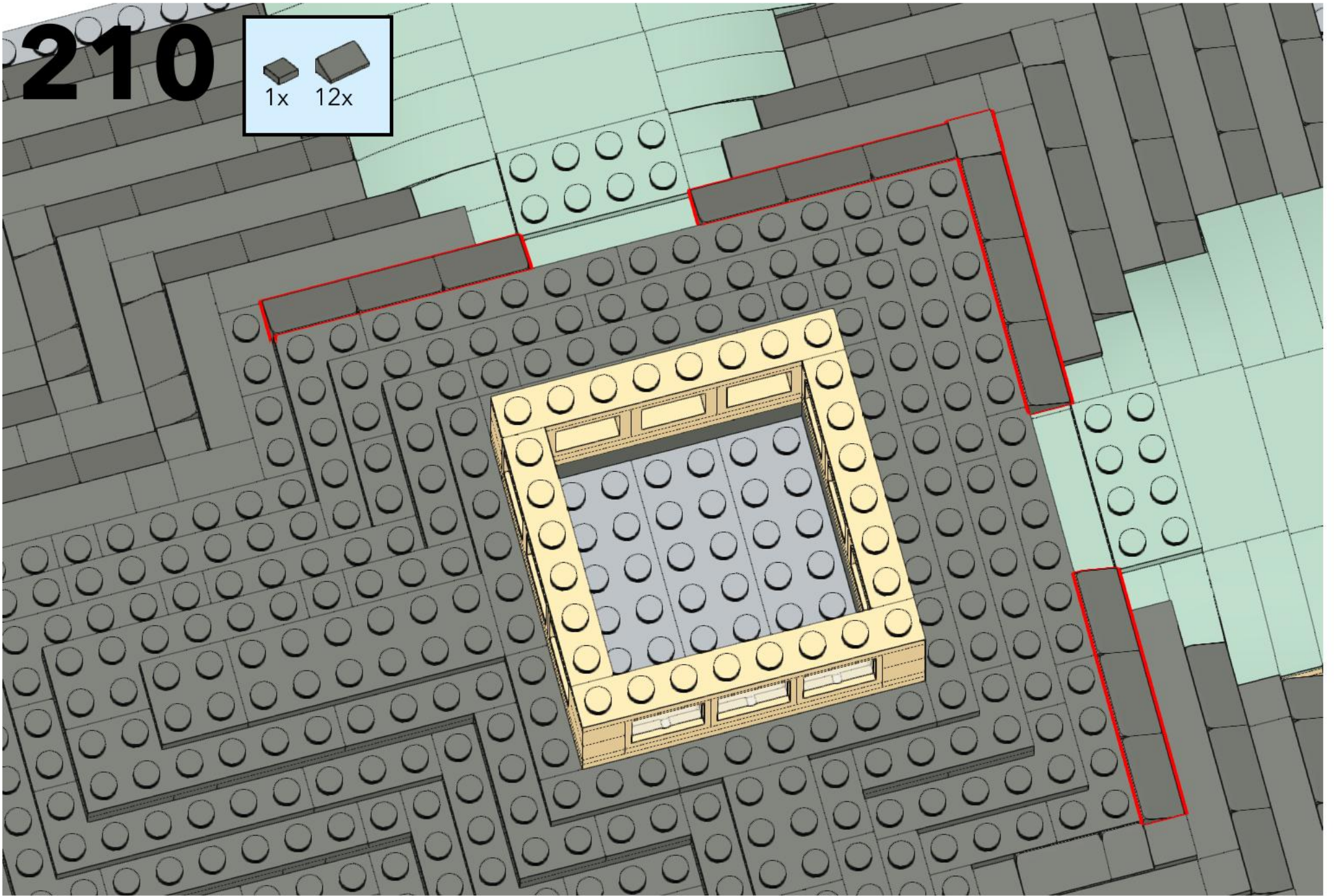
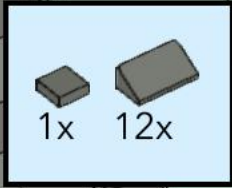

# 211

5x 2x 14x

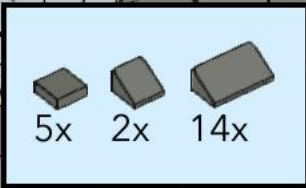
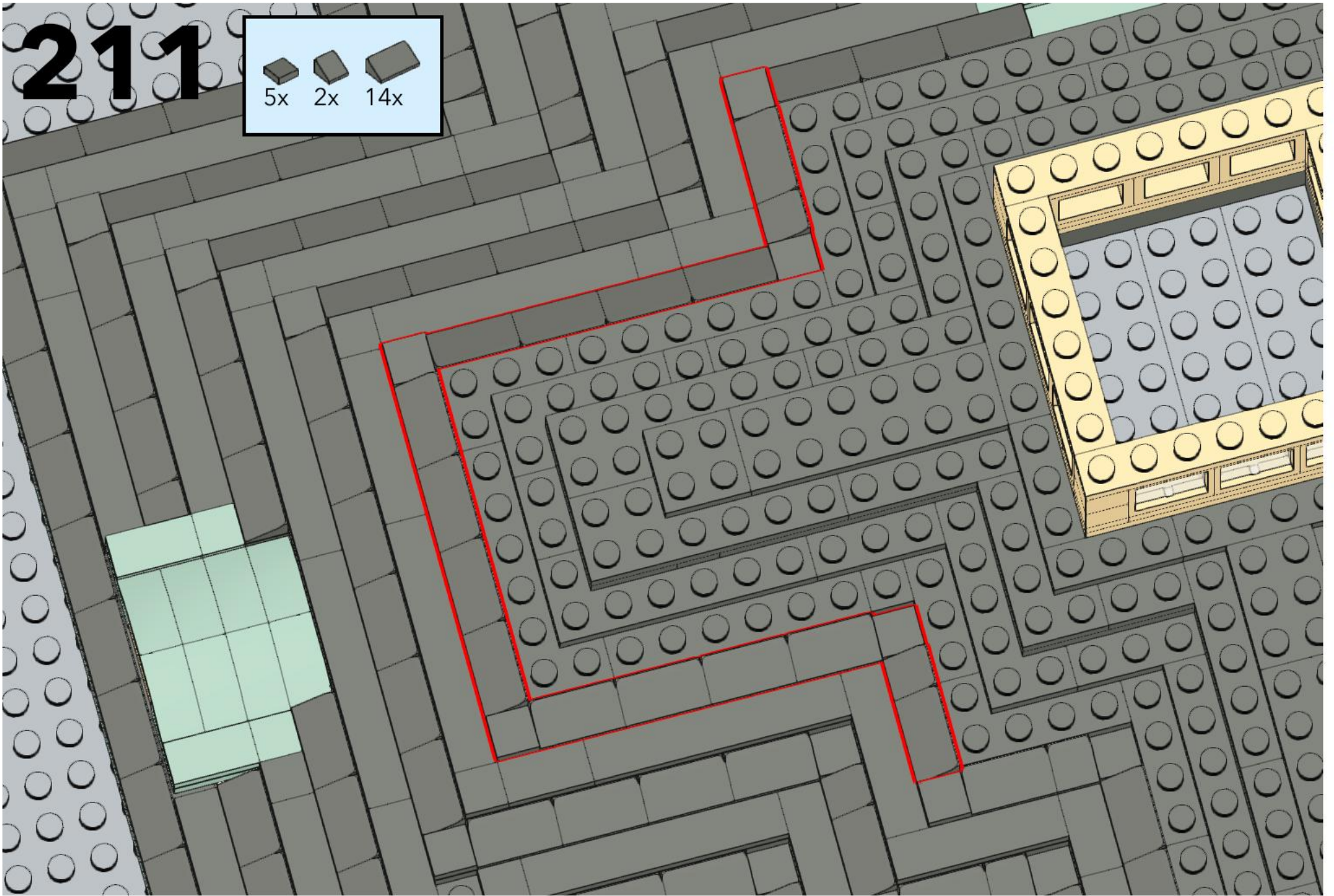
A legend box with a light blue background and a black border. It contains three small grey Technic brick icons. Below the first icon is the text '5x', below the second is '2x', and below the third is '14x'. The icons represent a 5-hole brick, a 2-hole brick, and a 14-hole brick, respectively.

# 212

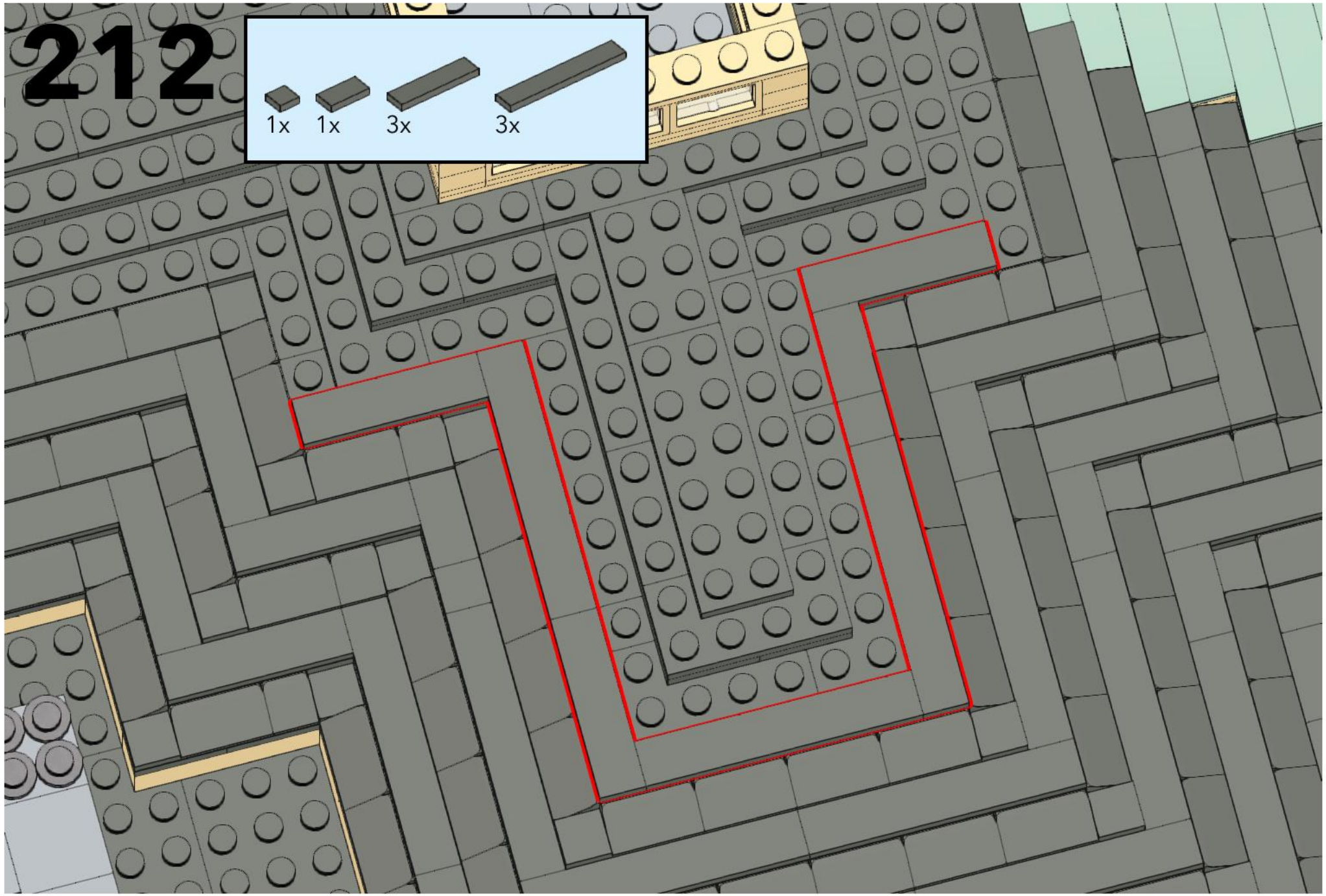
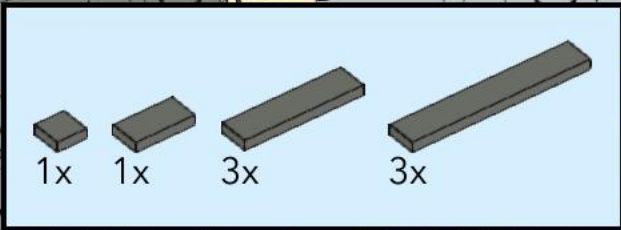

# 213

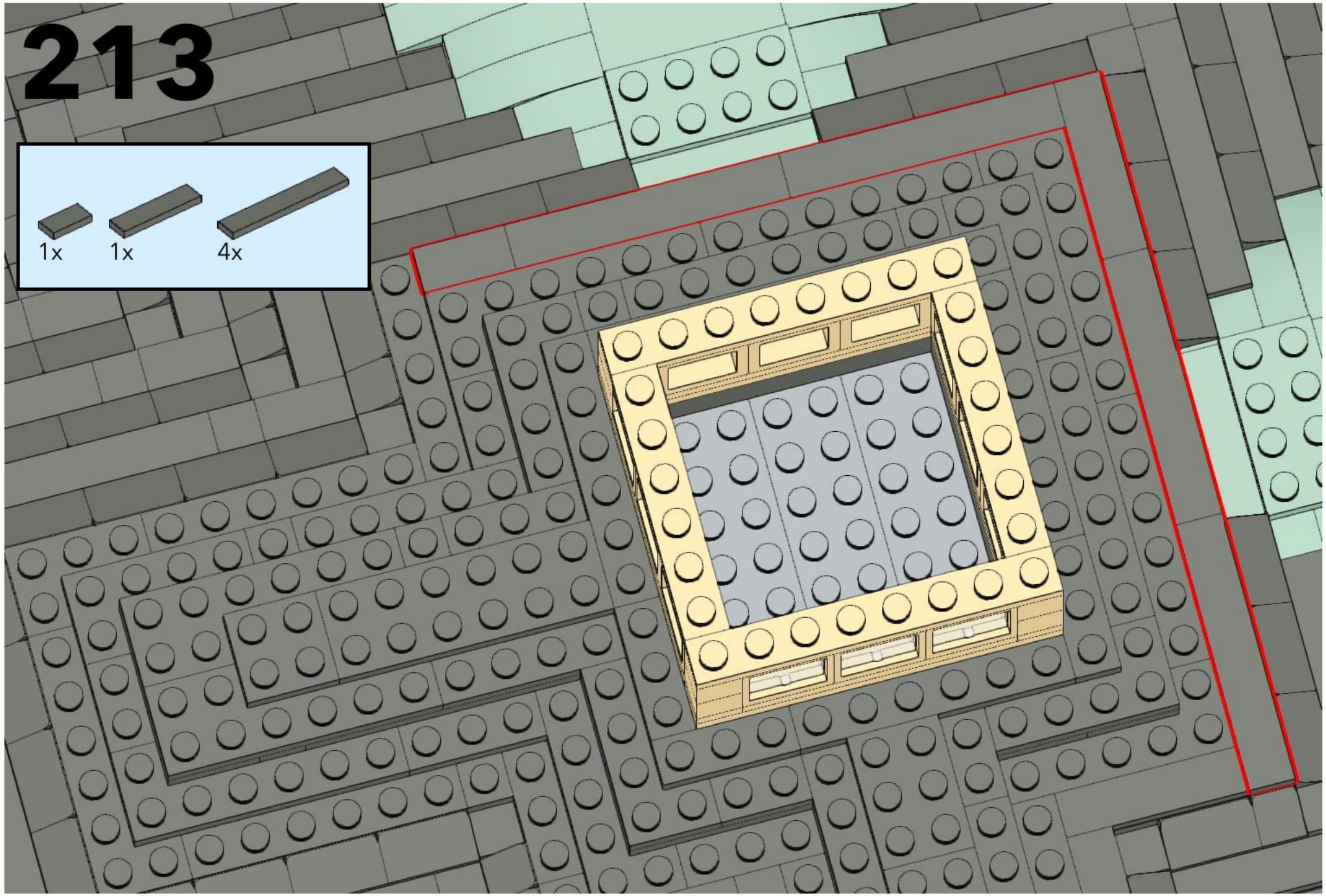
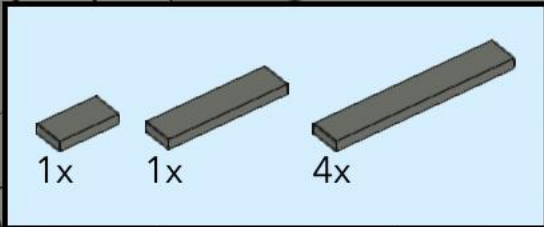

# 214

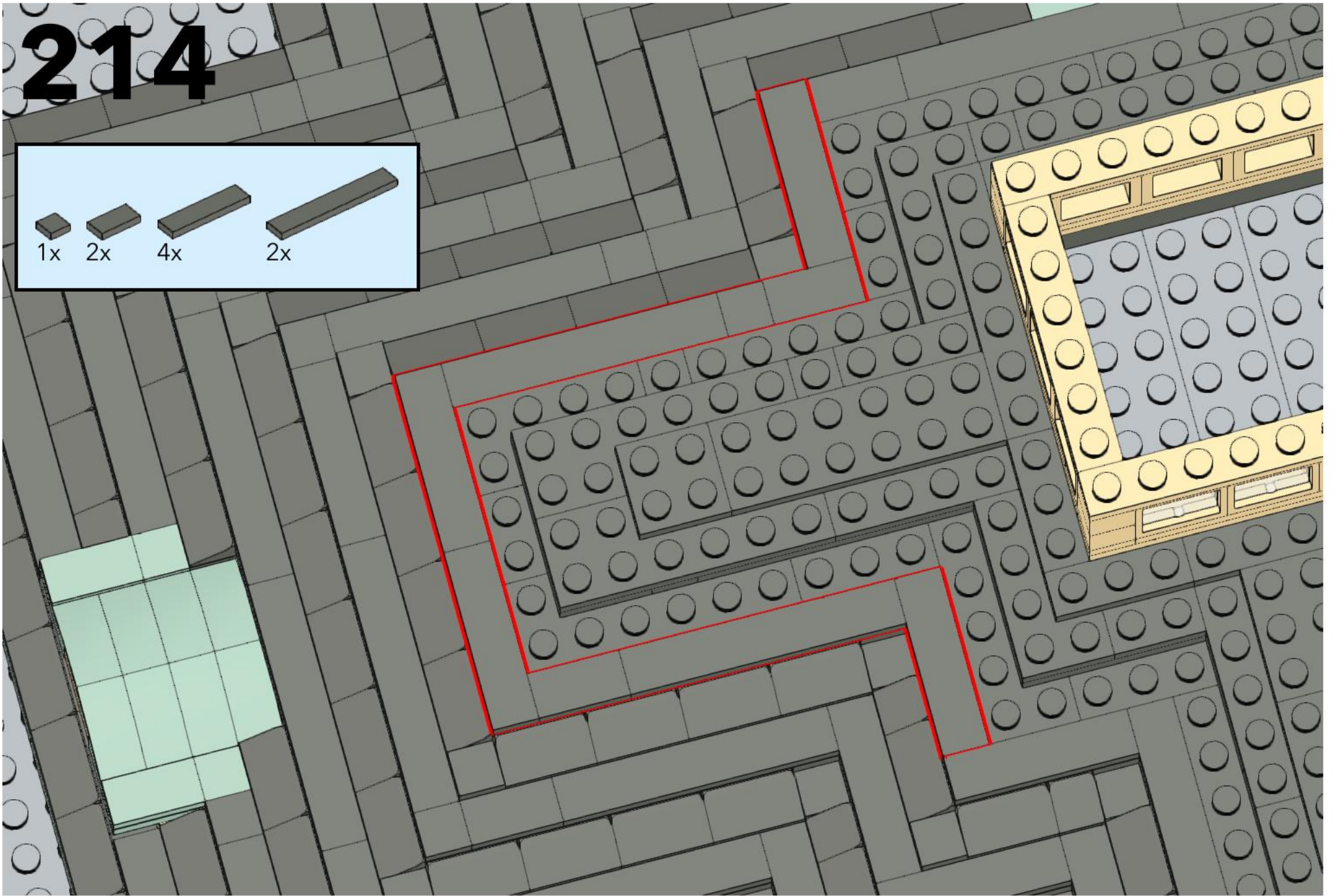
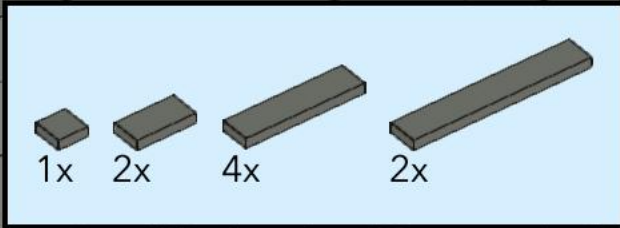

# 215

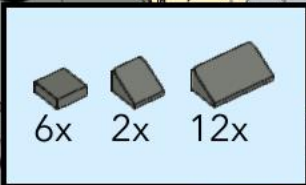

6x 2x 12x

This block contains a parts list for step 215. It features three small grey rectangular parts: a 1x2x2 brick, a 1x2x3 brick, and a 1x3x3 brick. Below each part is its quantity: 6x, 2x, and 12x respectively.

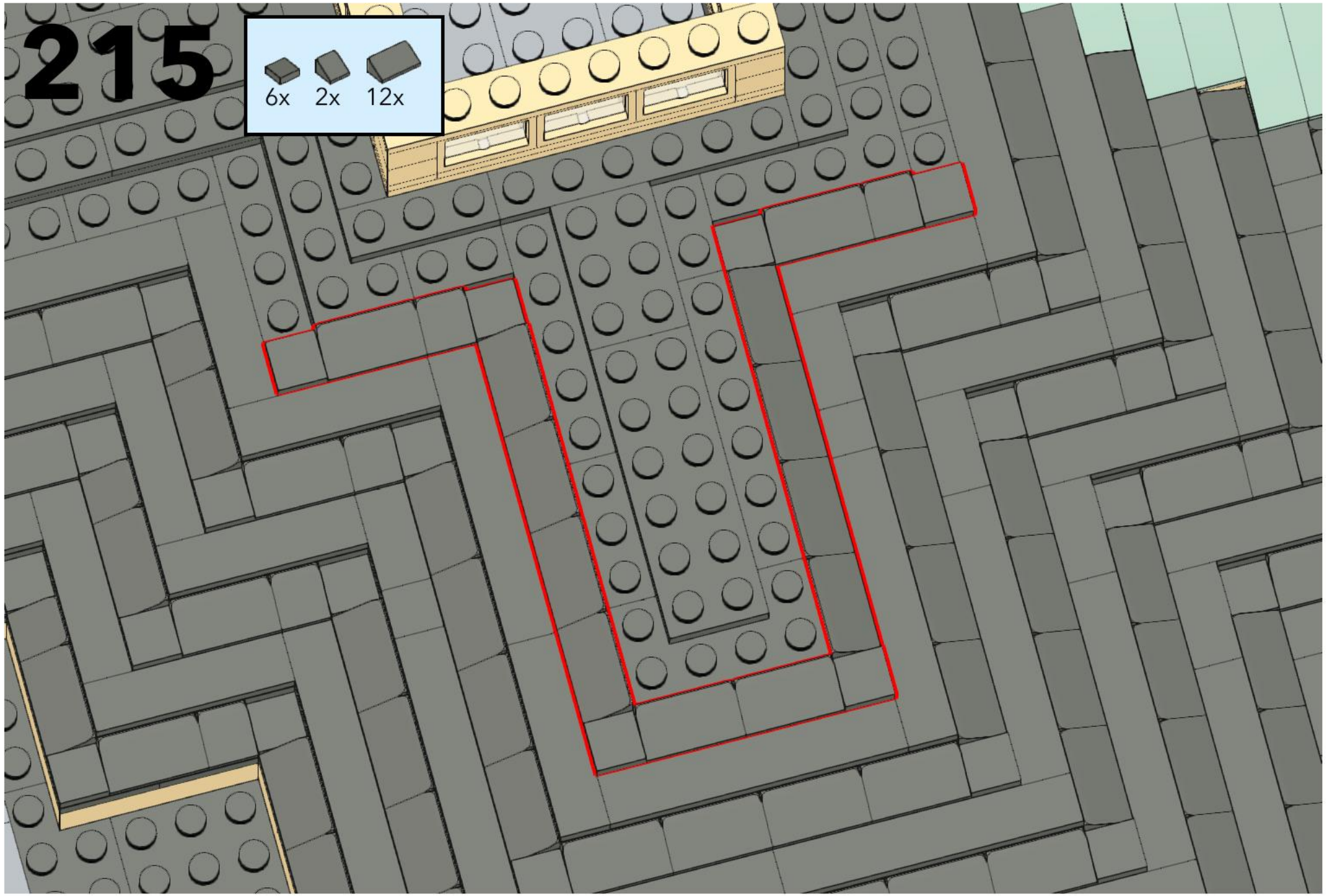



# 216

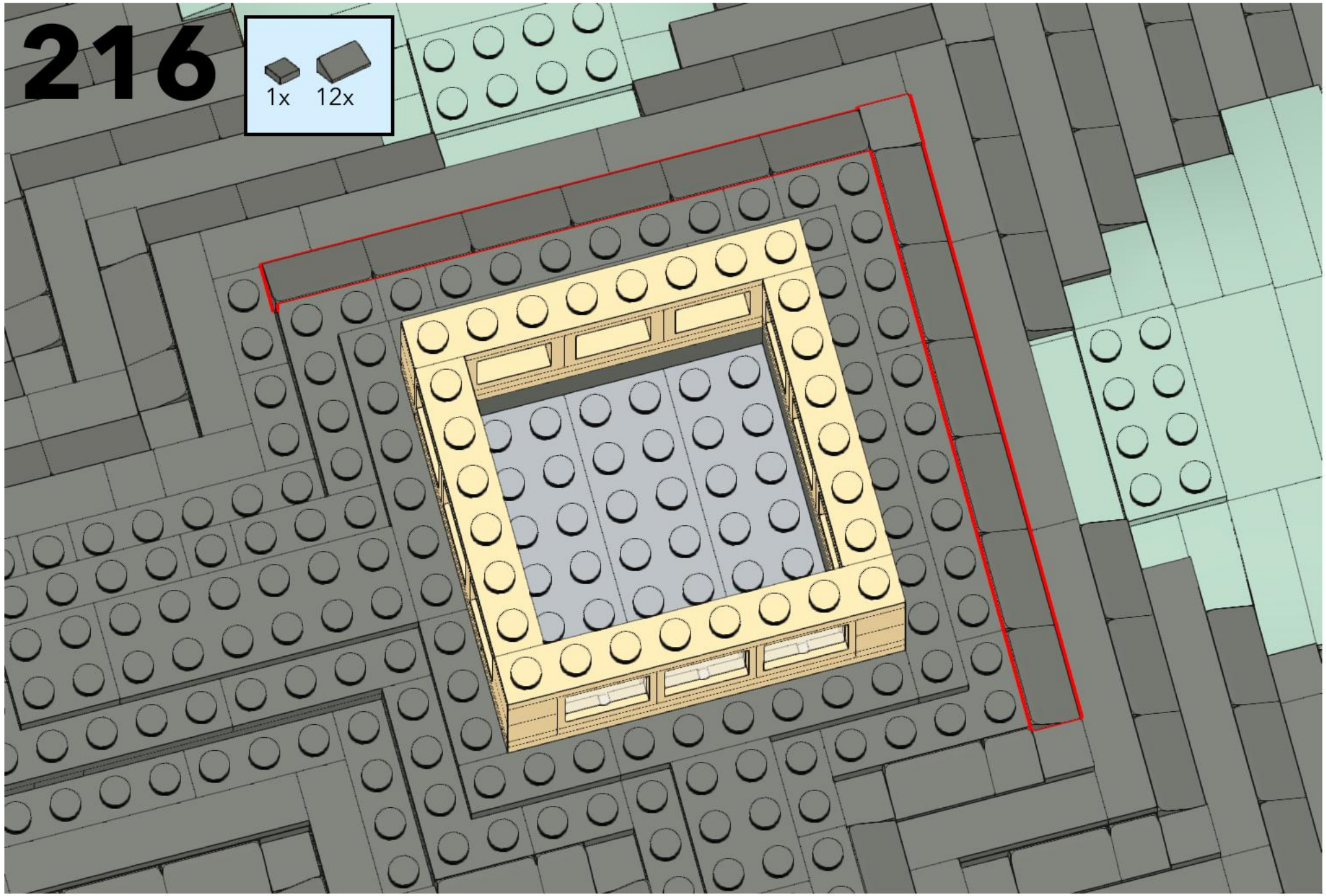
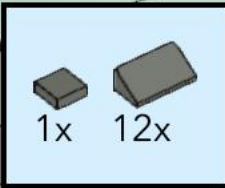

# 217

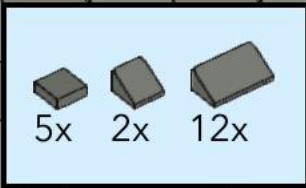

5x 2x 12x

This block contains a parts list for step 217. It features three small grey 3D models of the required parts: a 1x2x2 brick, a 1x2x3 brick, and a 1x3x3 brick. Below each model is its quantity: 5x, 2x, and 12x respectively.

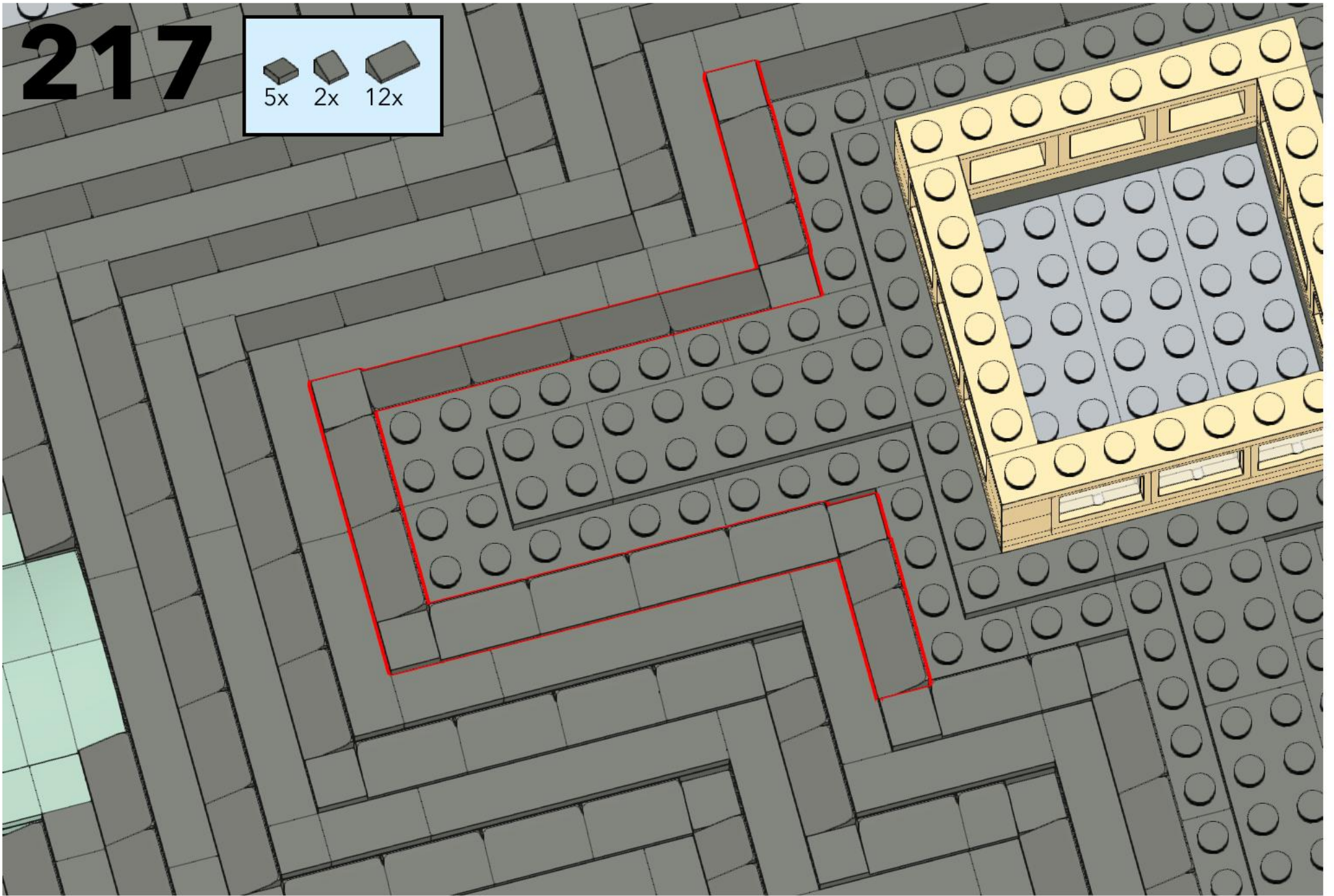

# 218

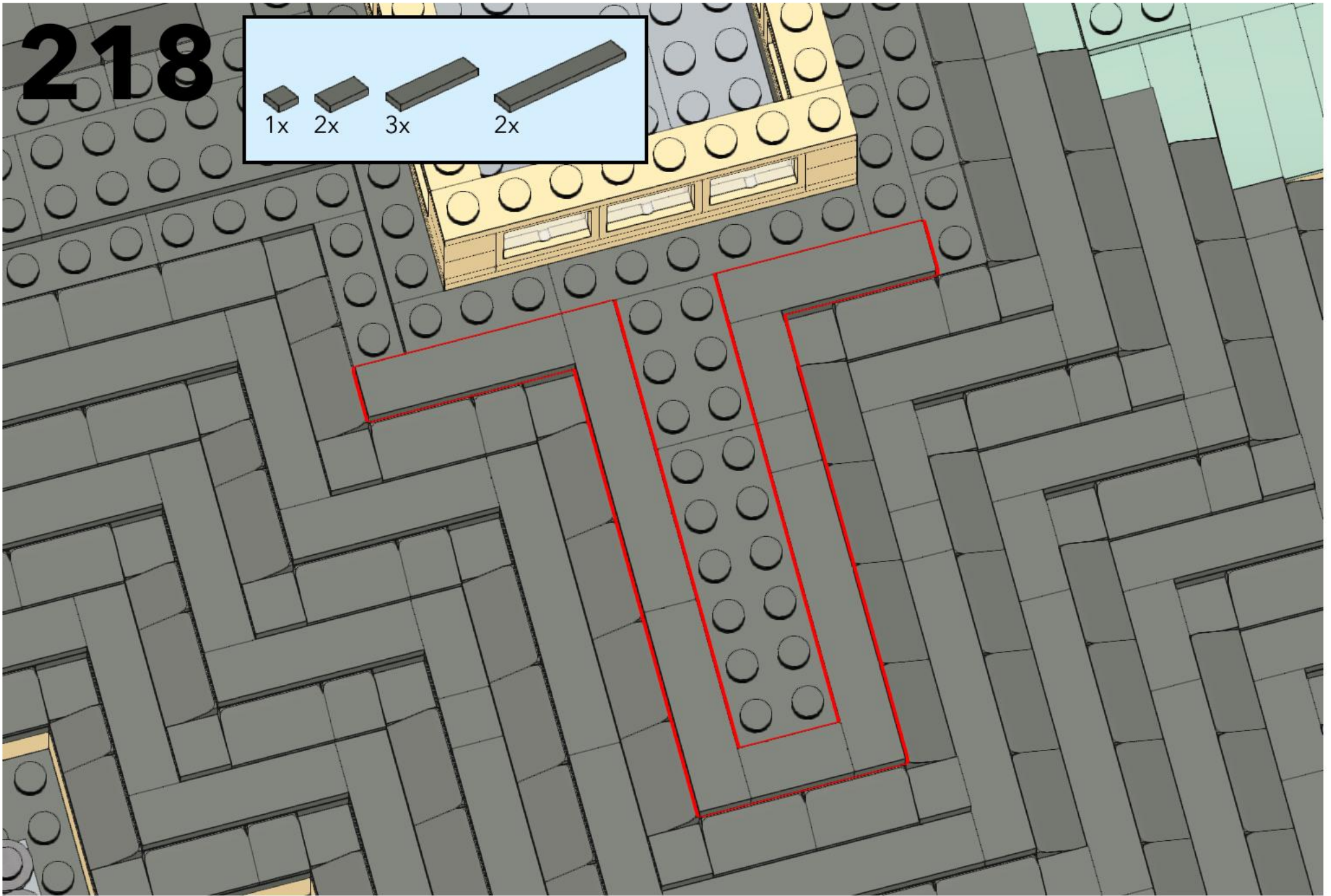
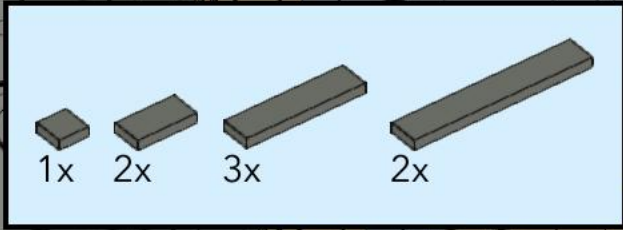

# 219

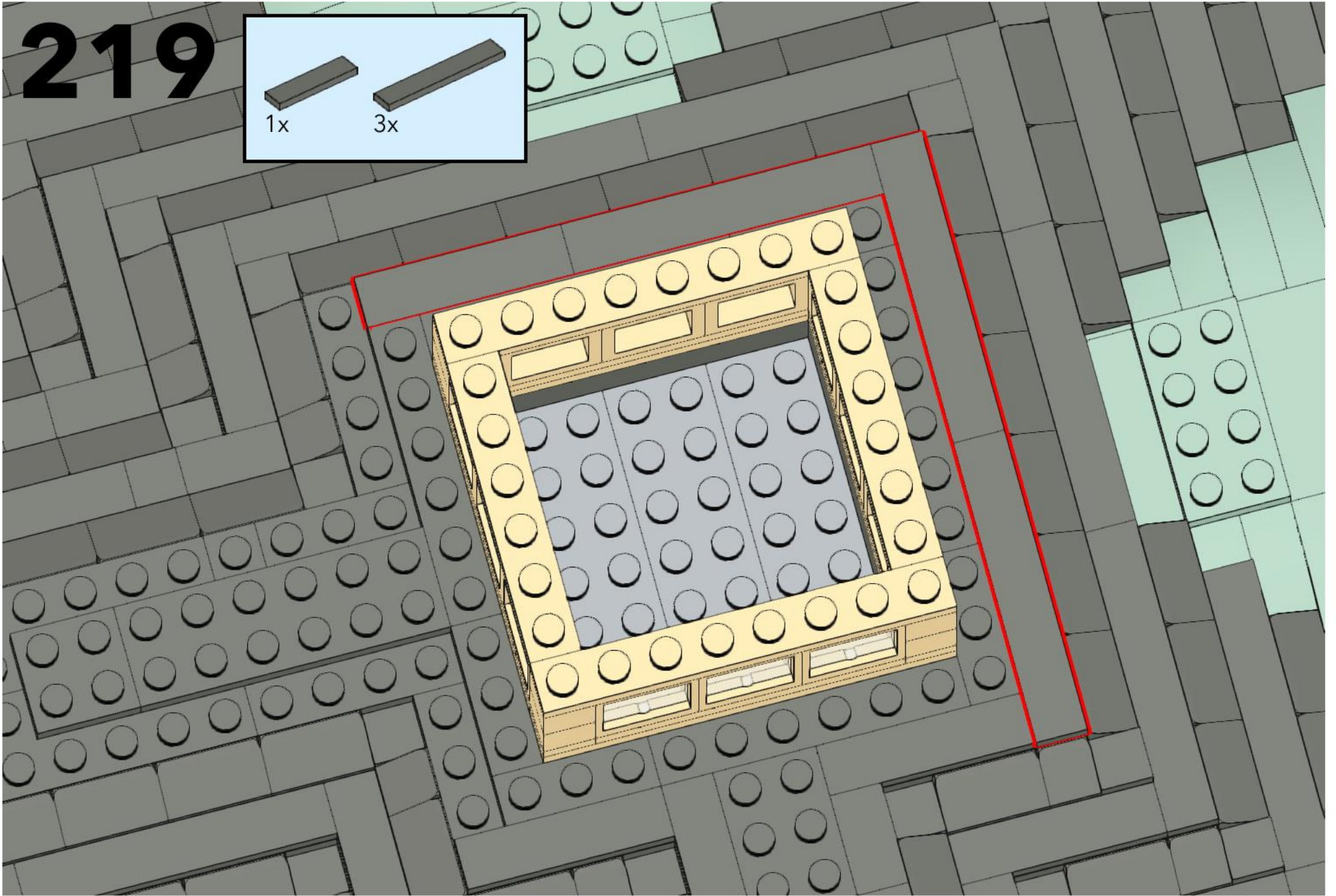
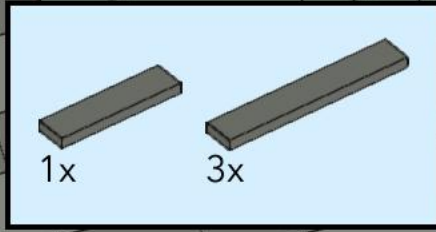

# 220

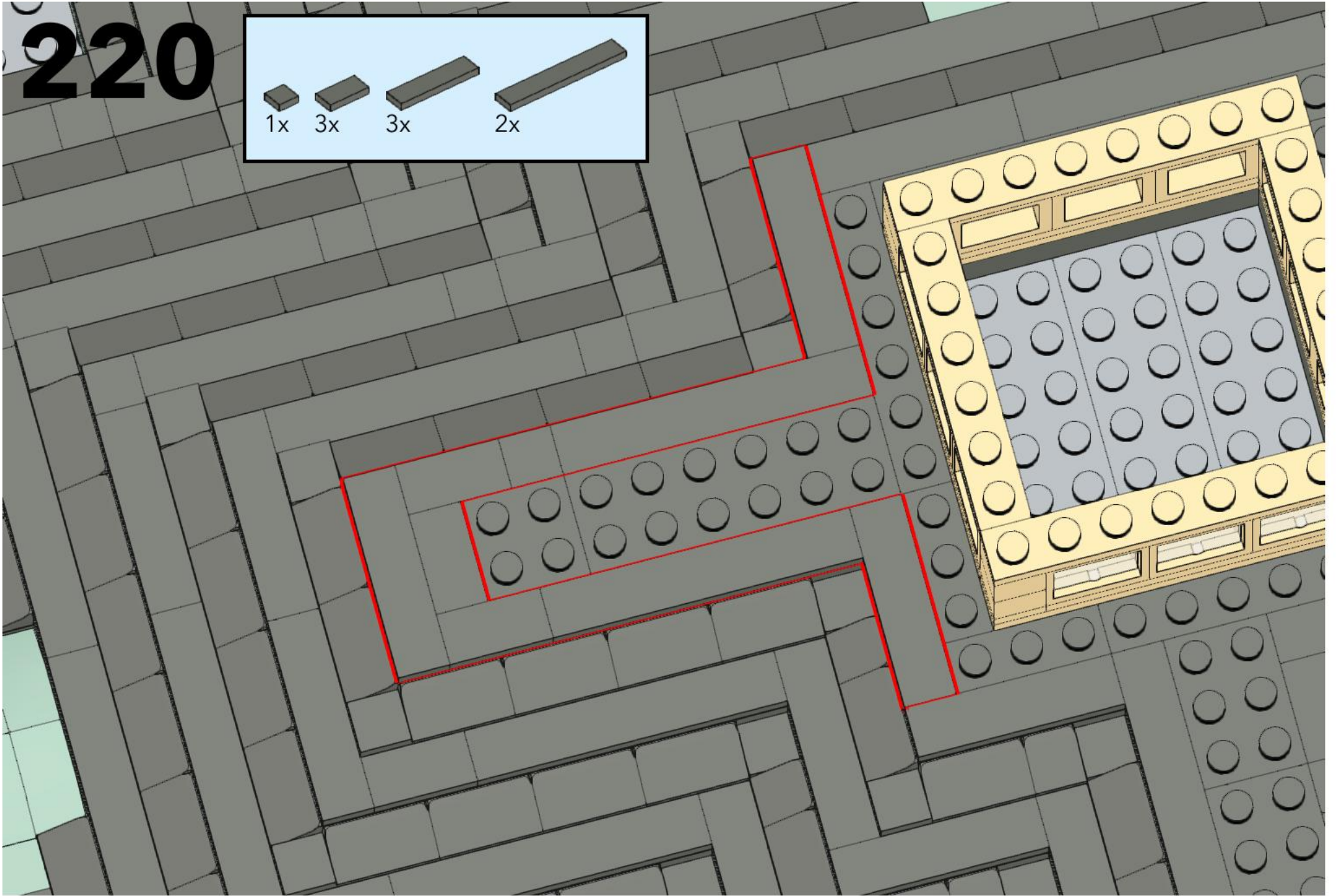
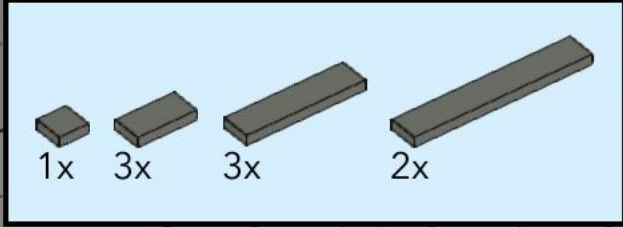

# 221

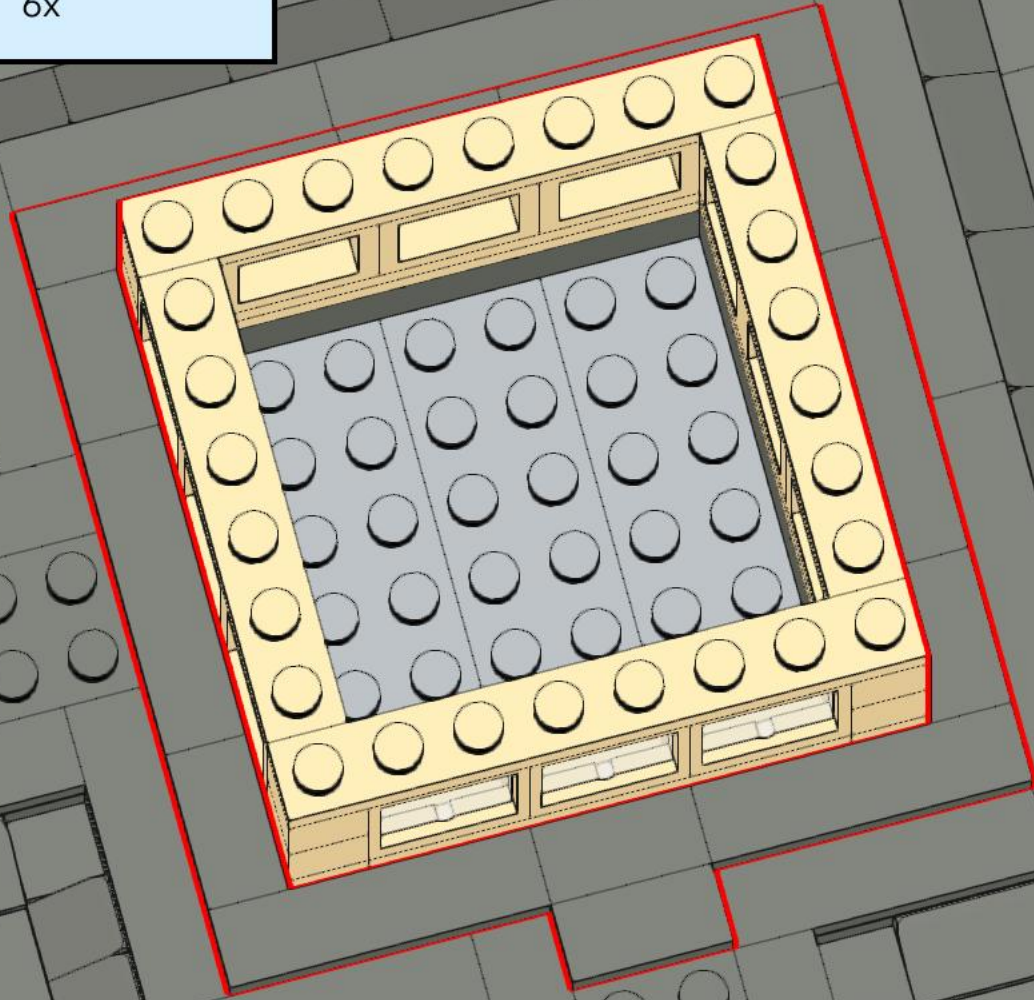
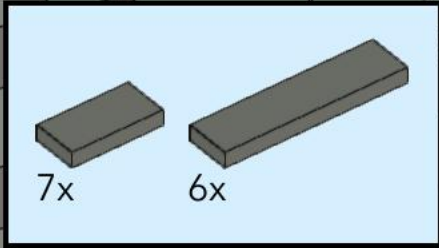

# 222

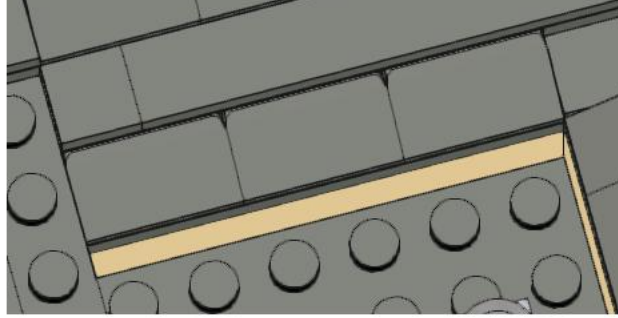
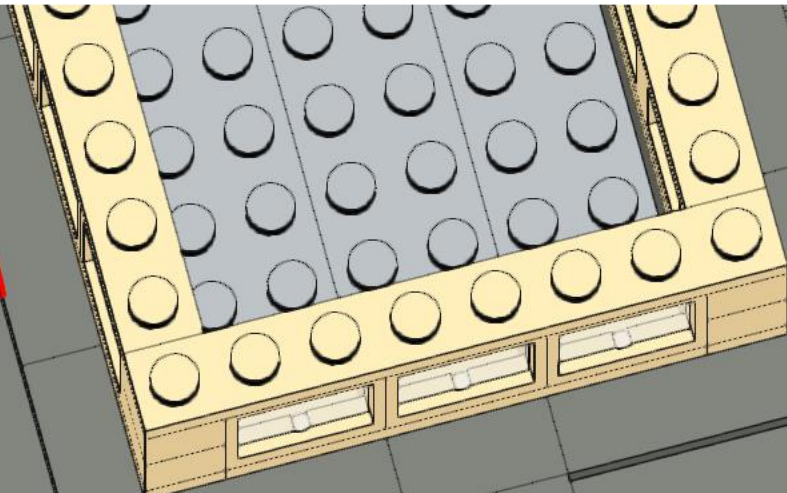
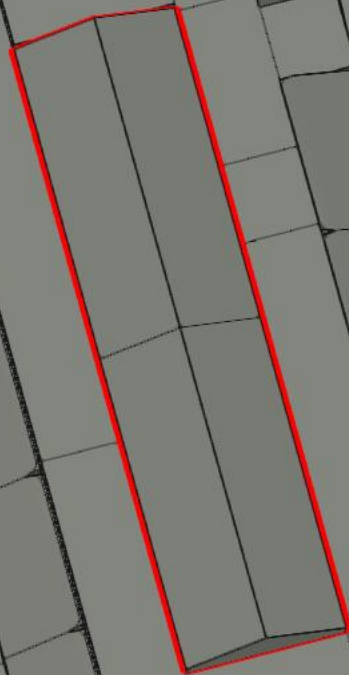
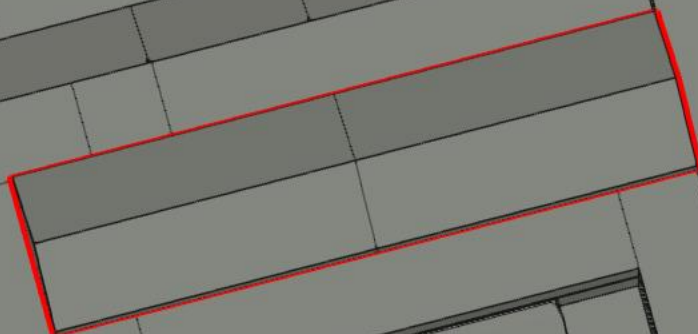
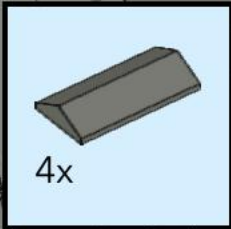

# 223

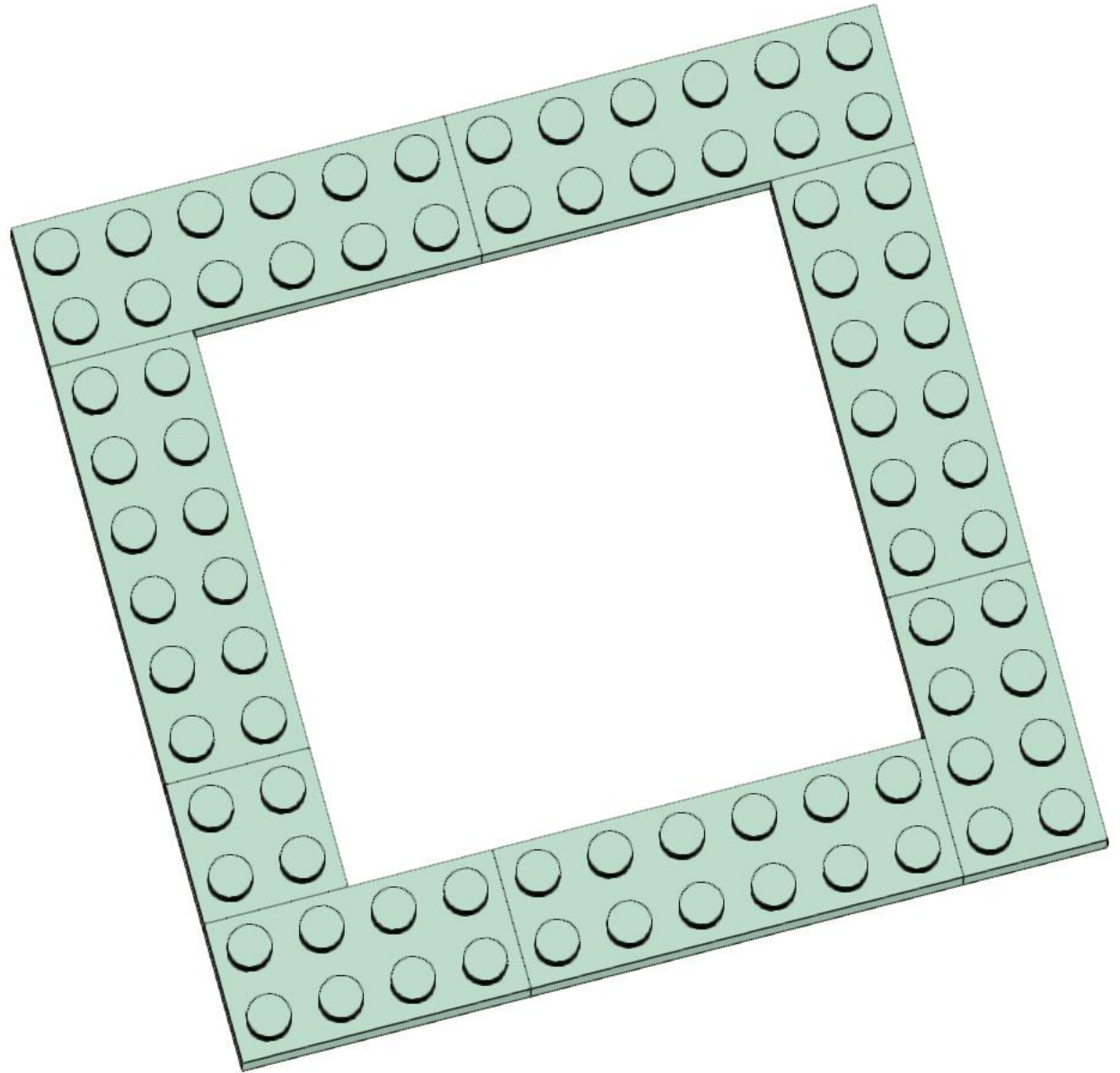
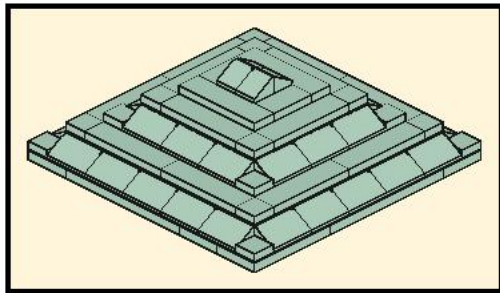
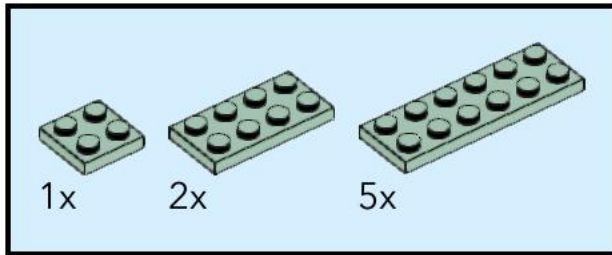



# 224

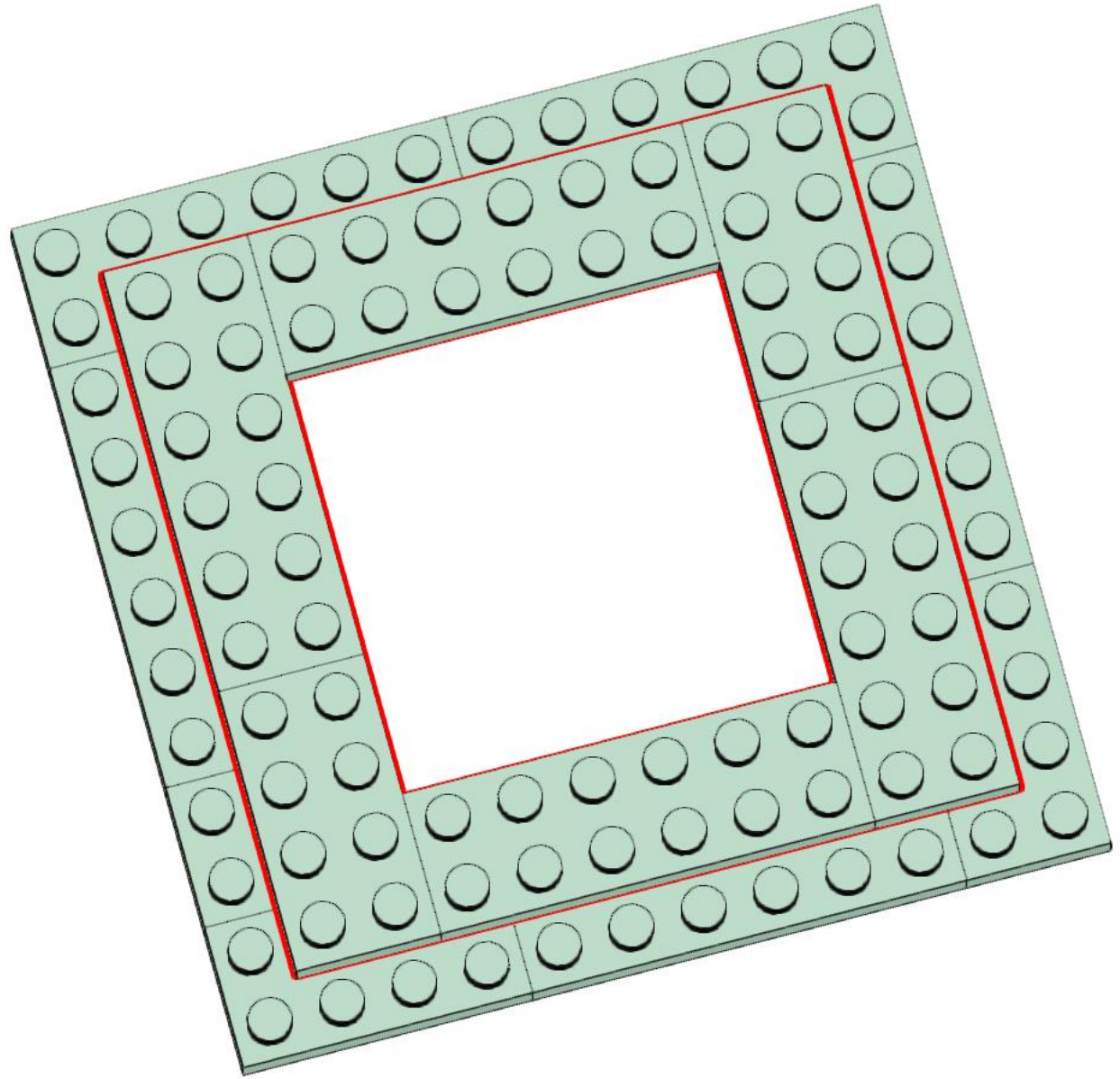
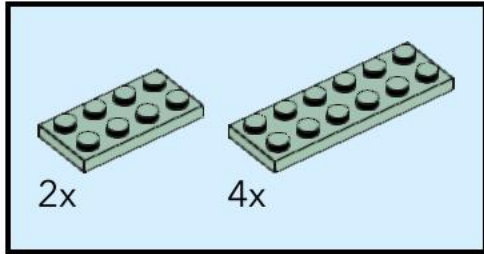

# 225

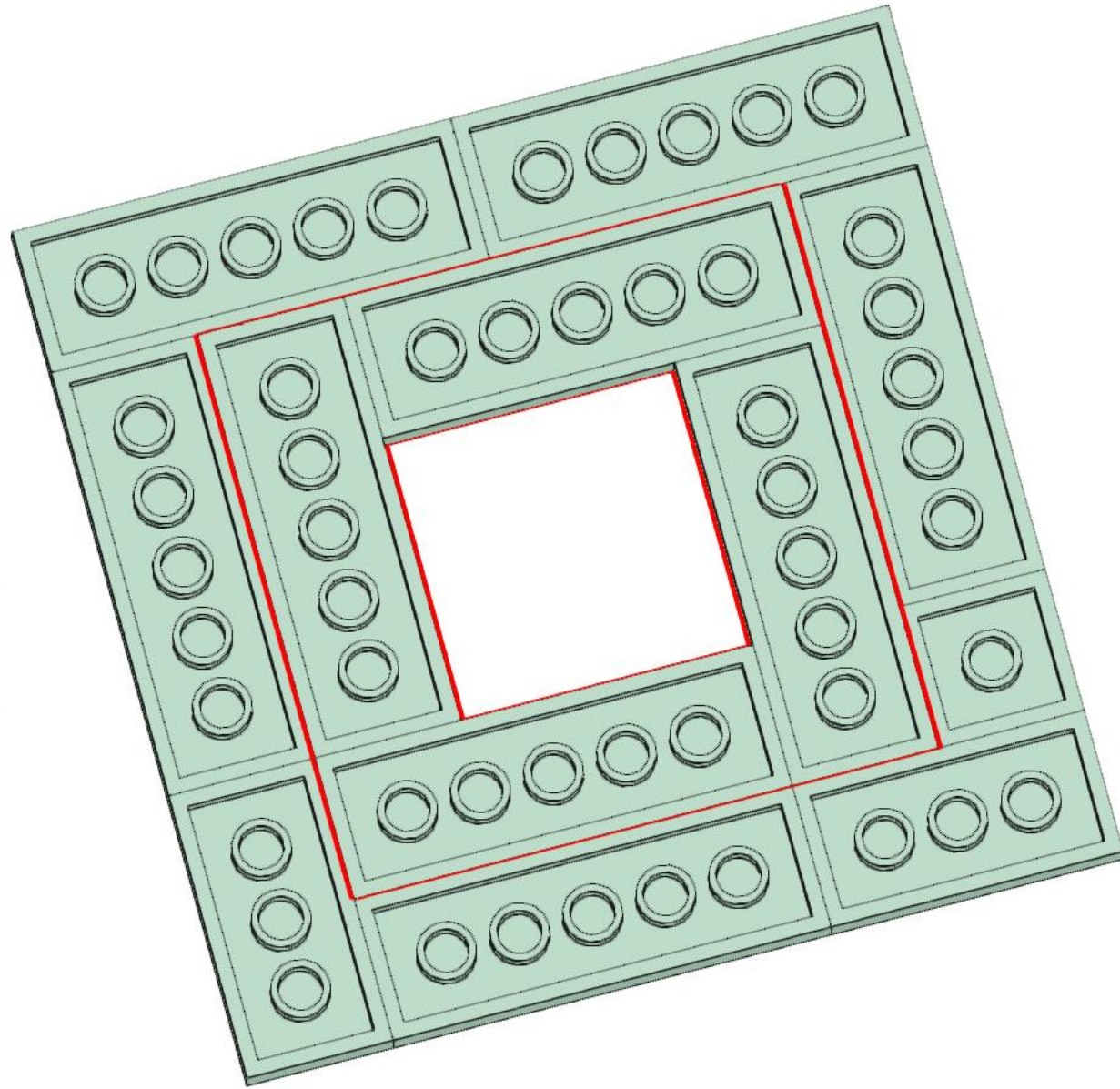
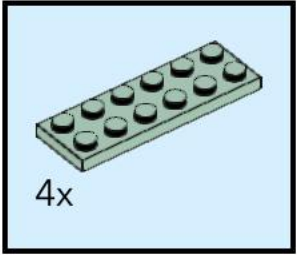

# 226

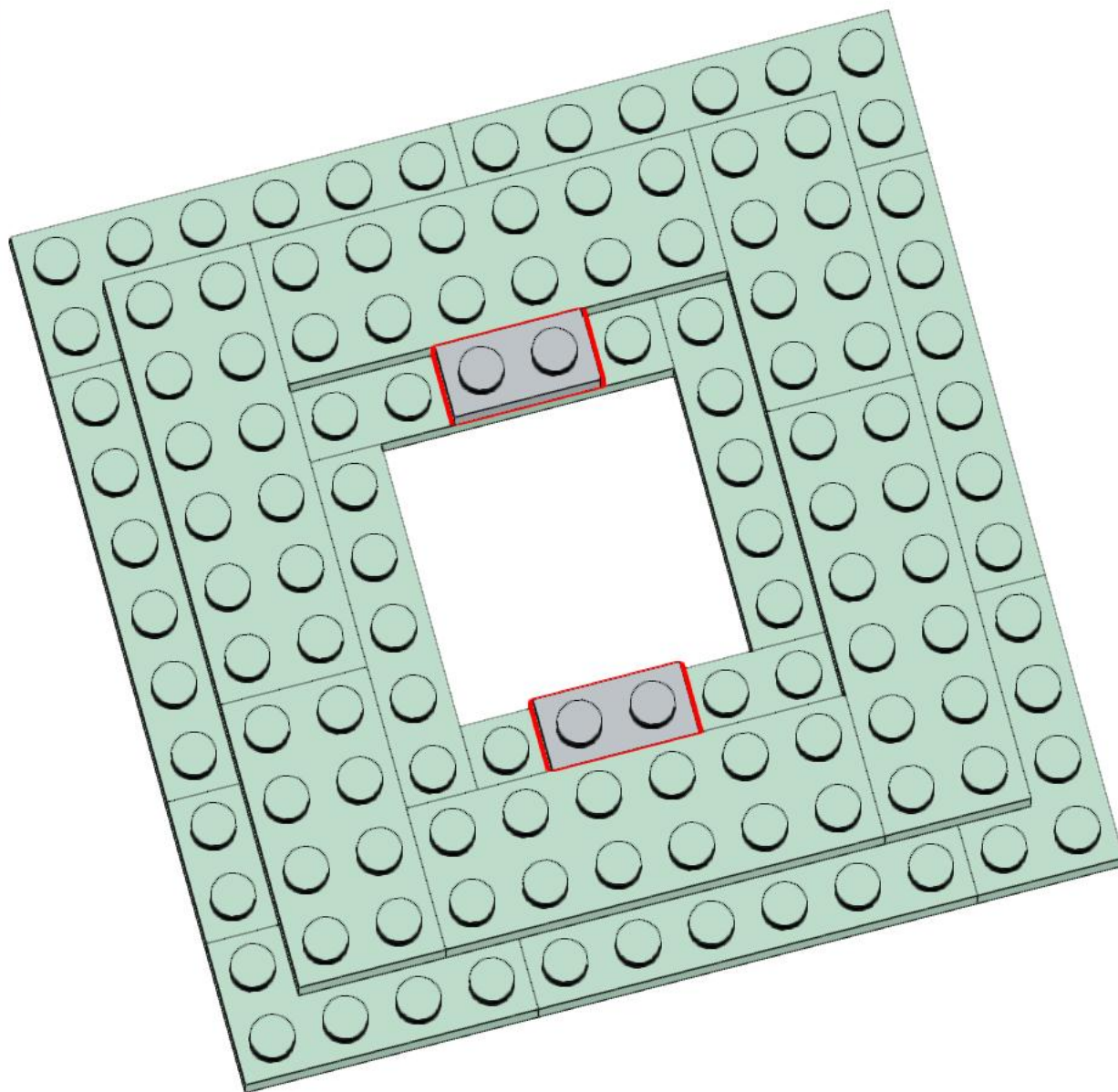
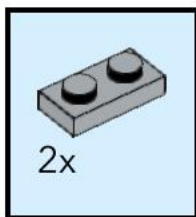

# 227

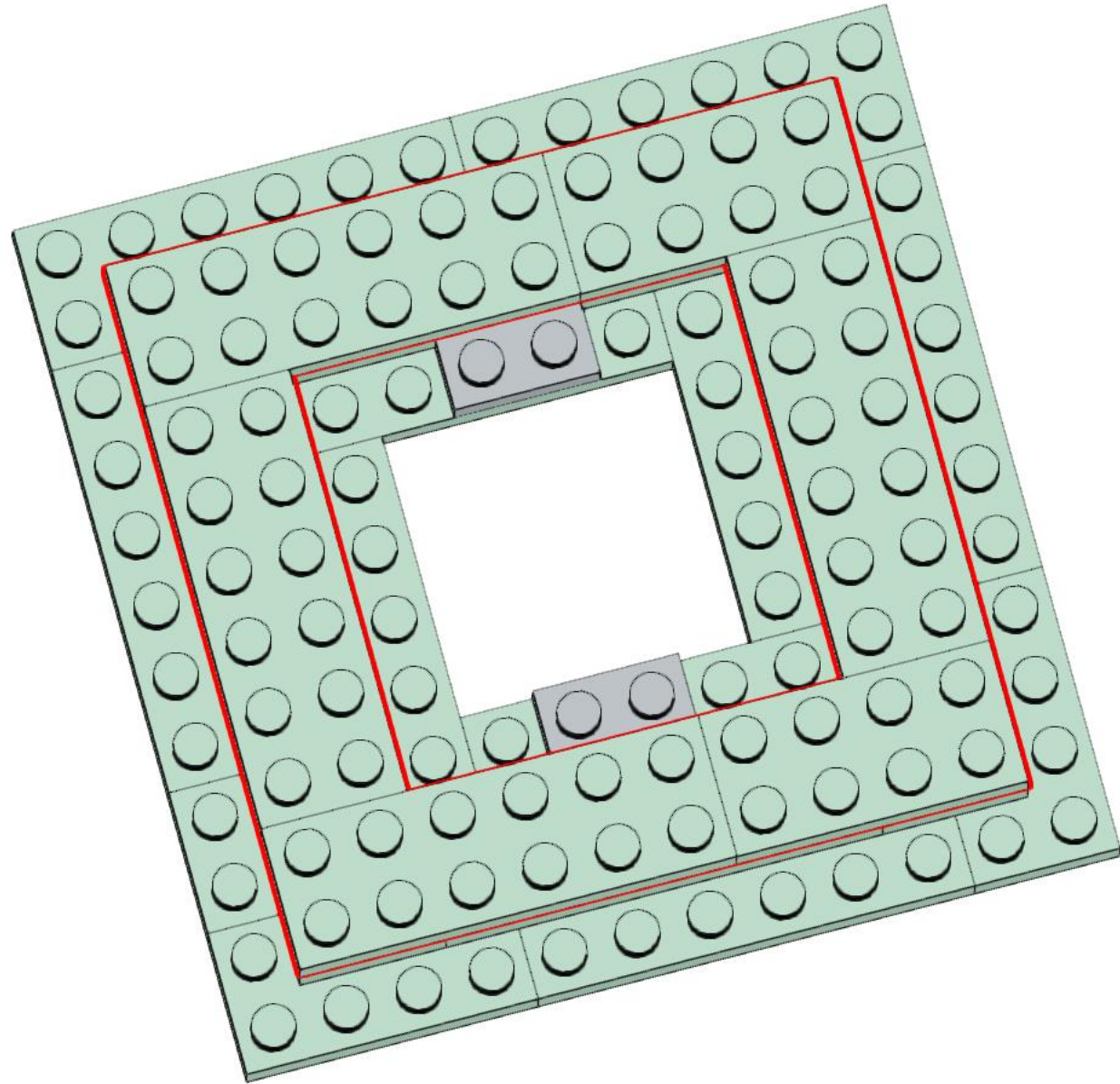
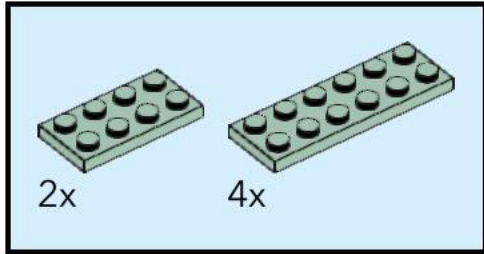

# 228

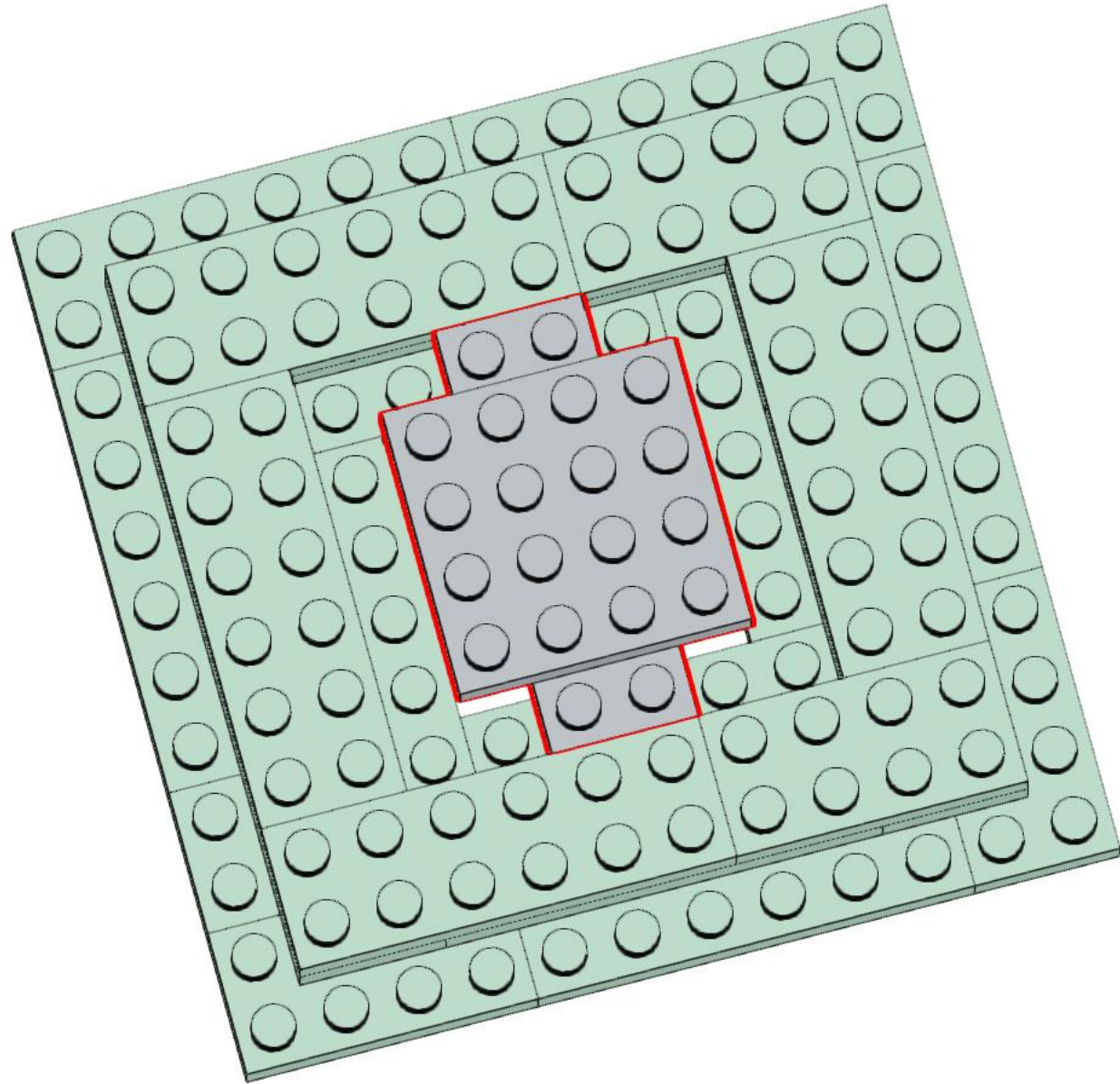
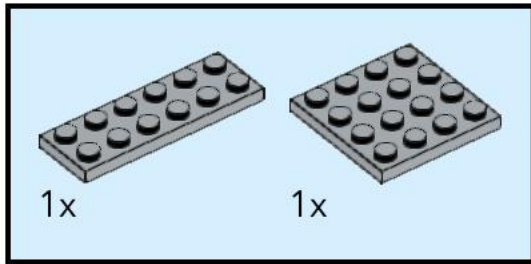

# 229

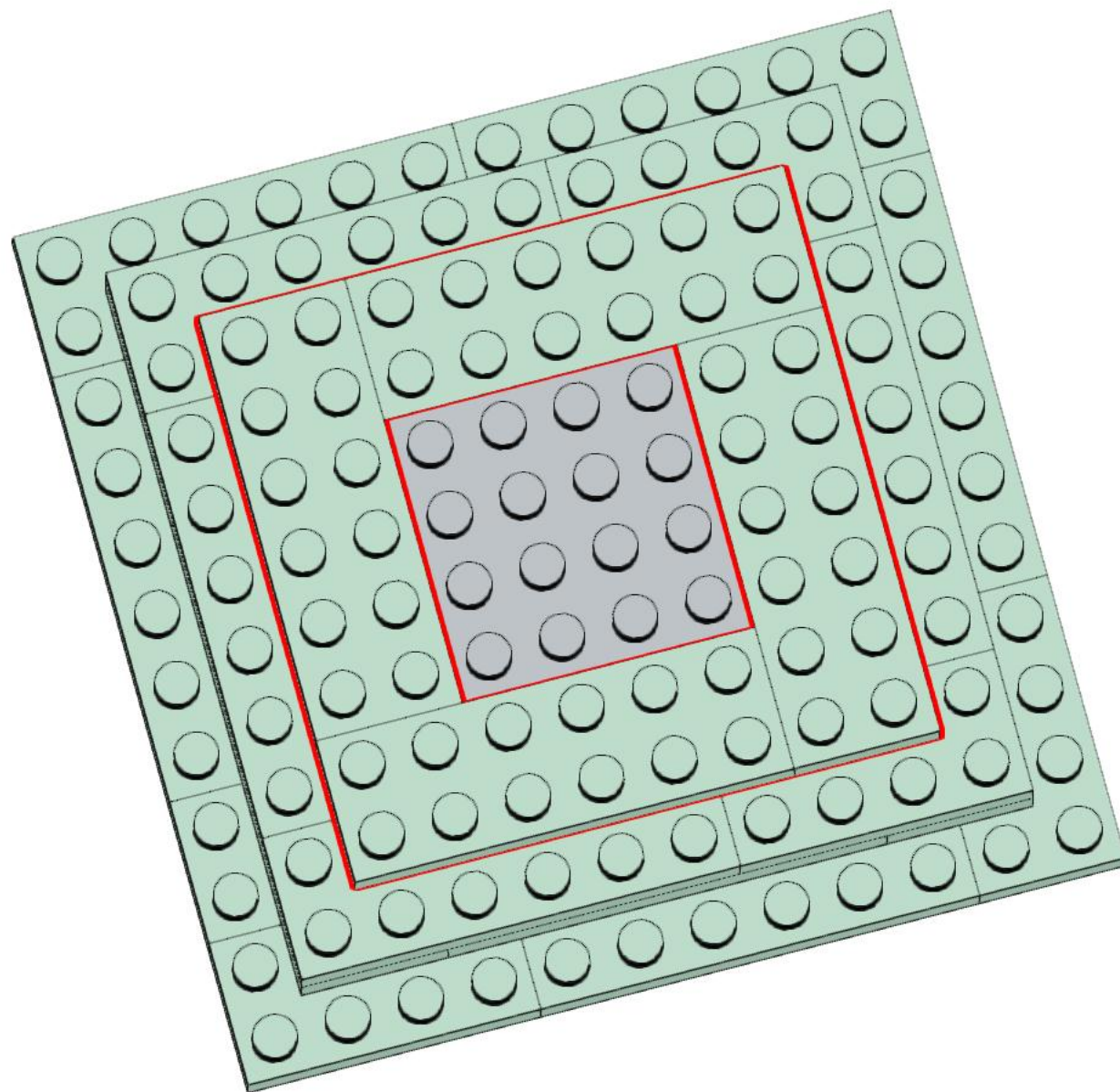
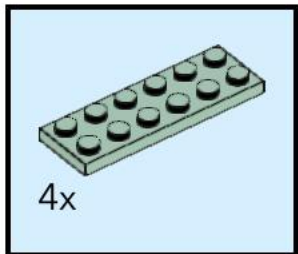

# 230

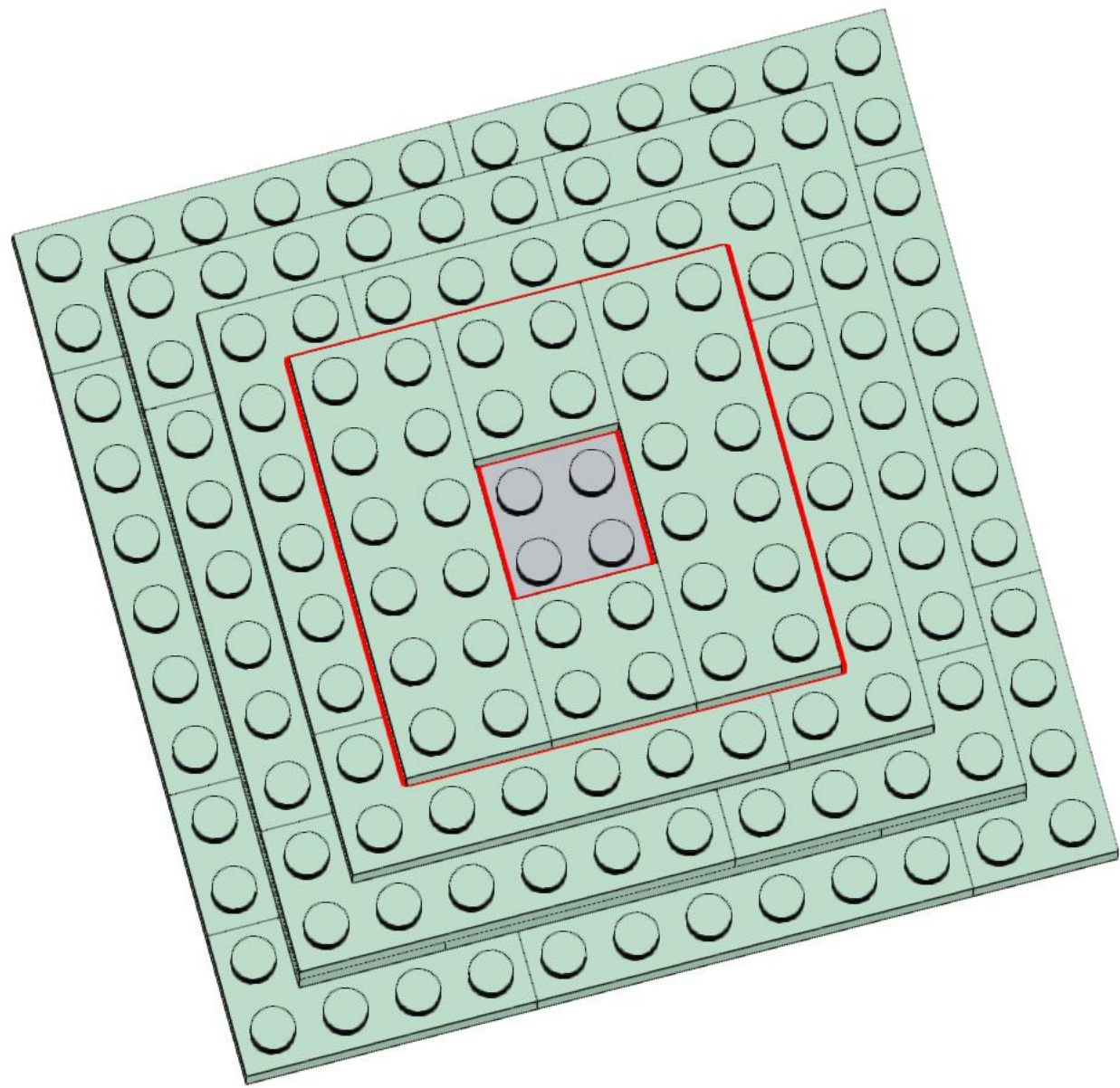
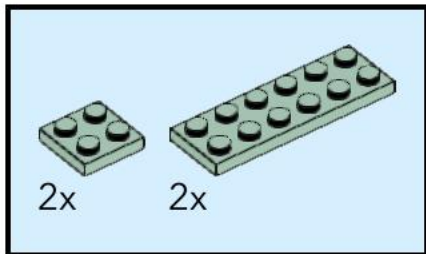

# 231

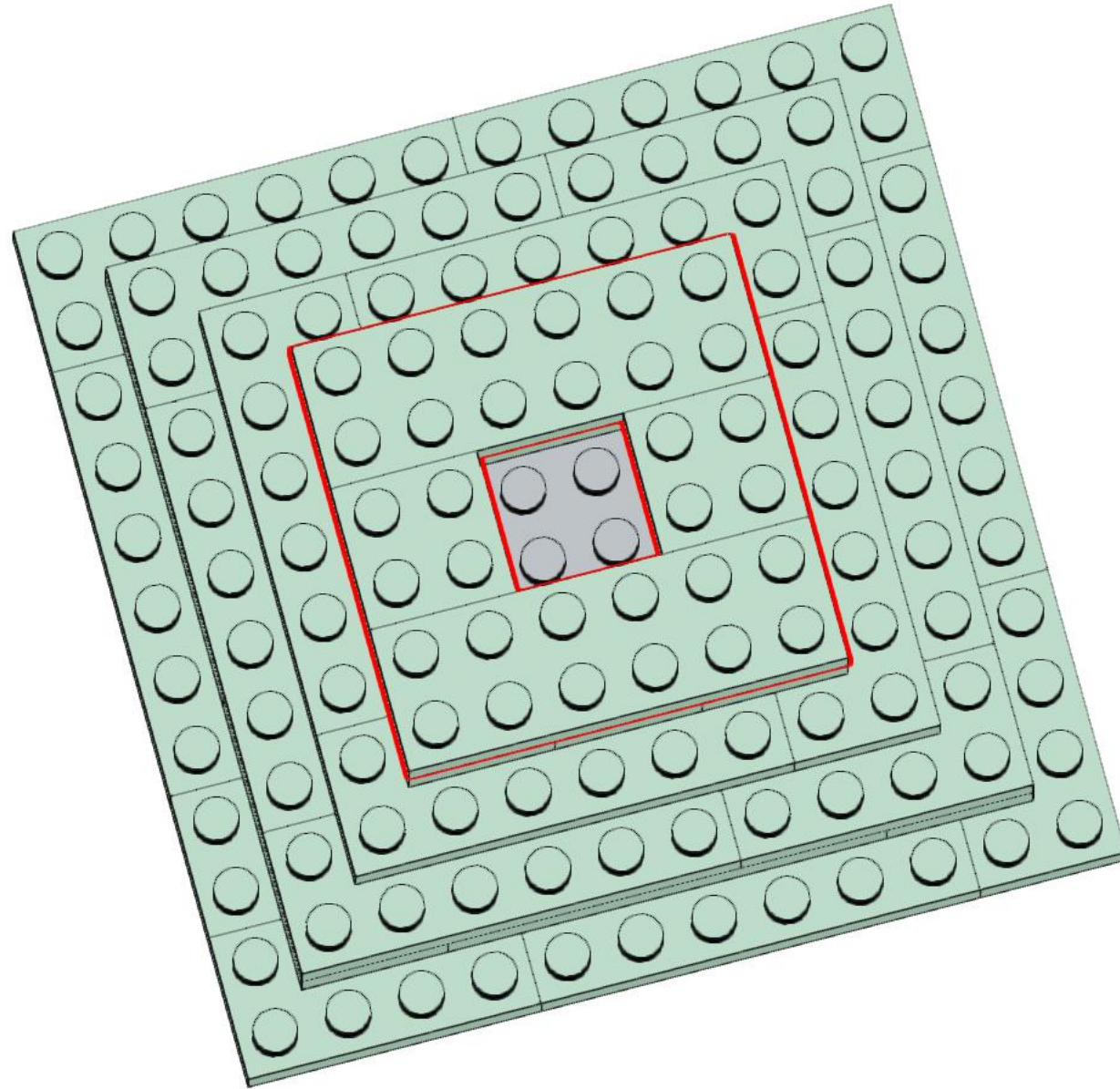
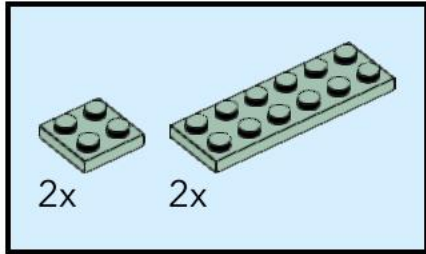



# 232

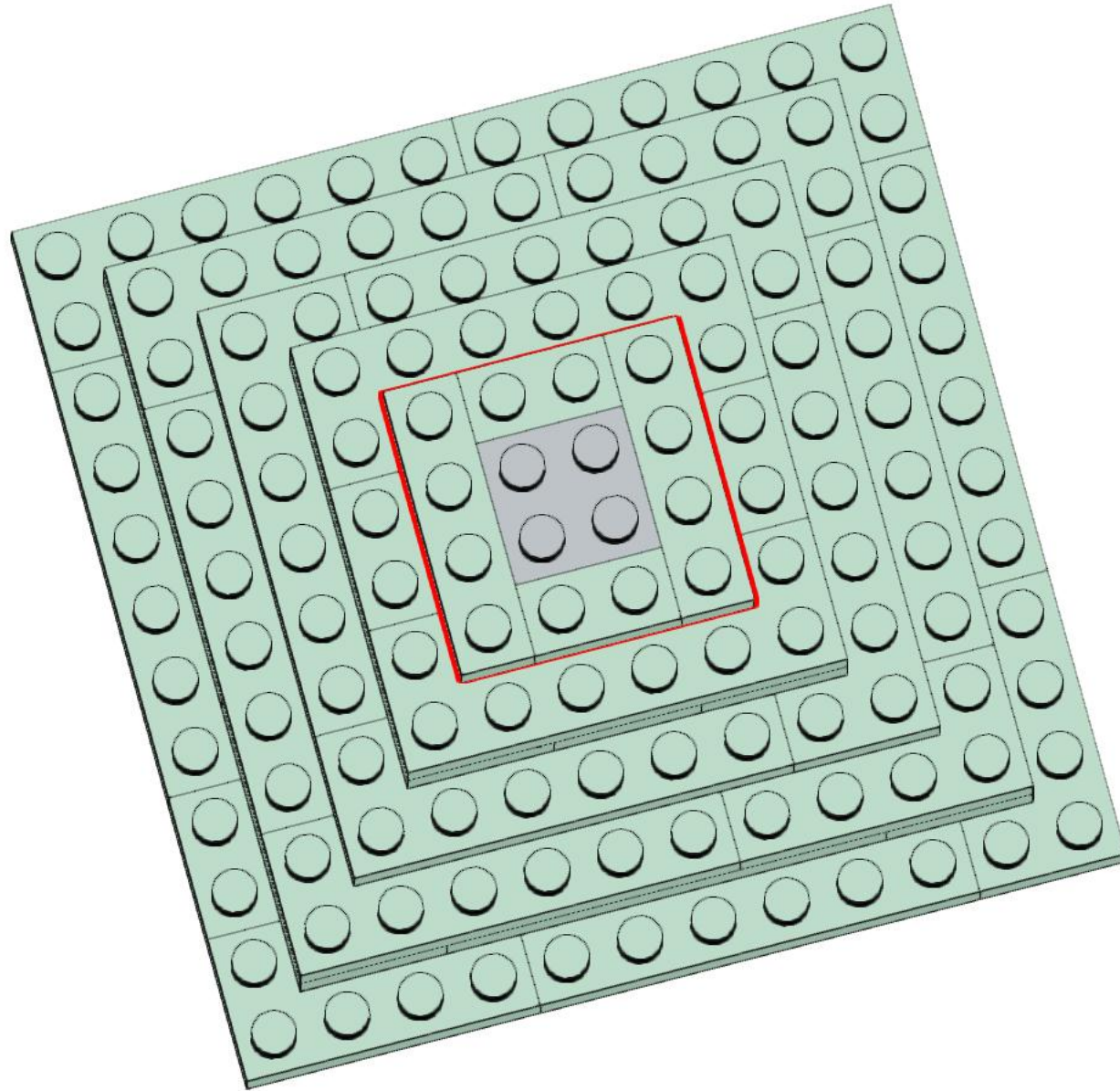
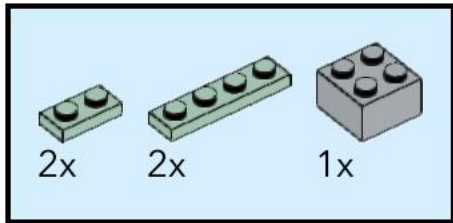

# 233

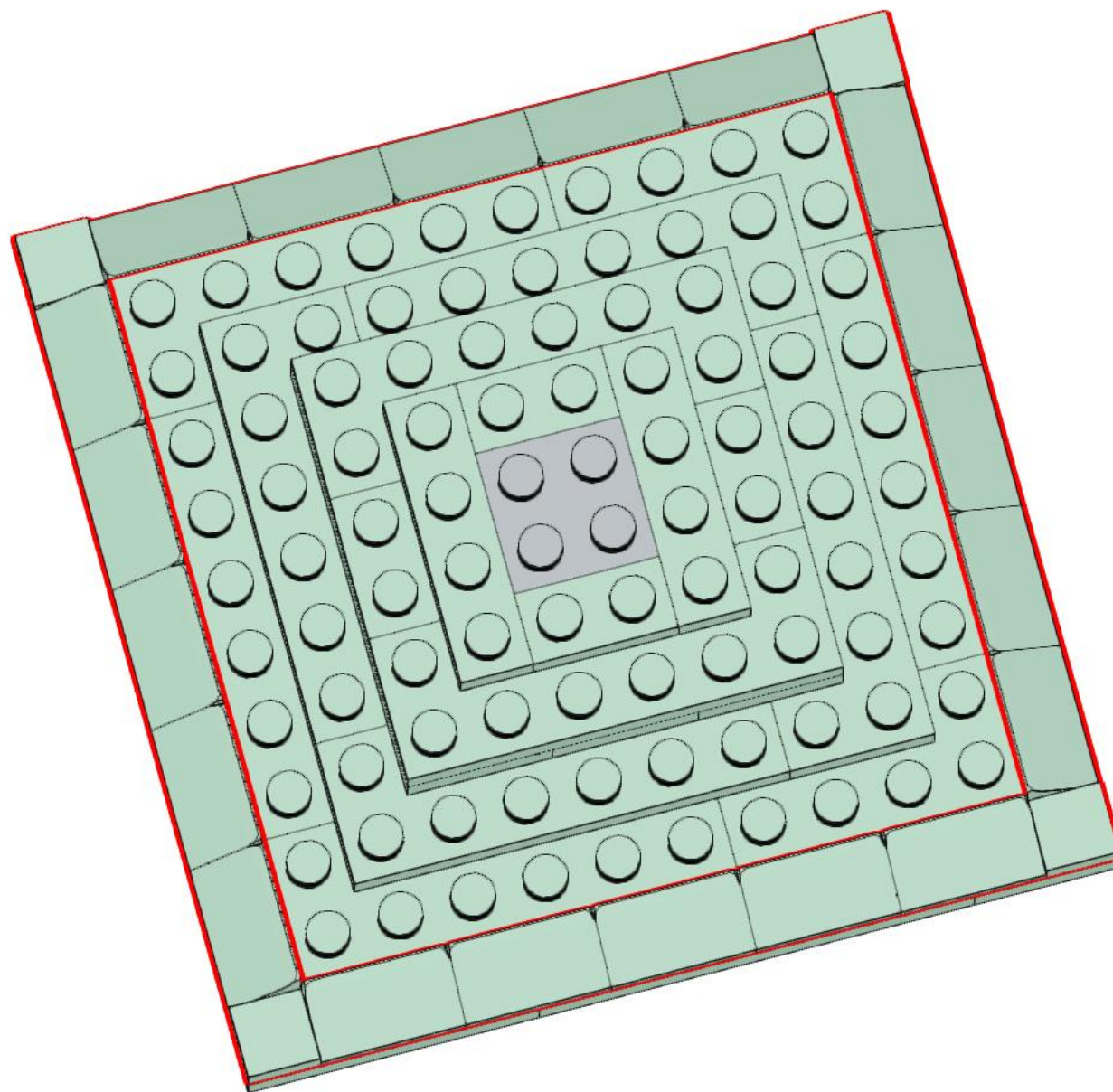
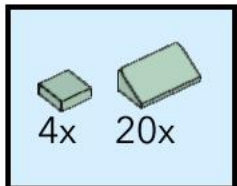

# 234

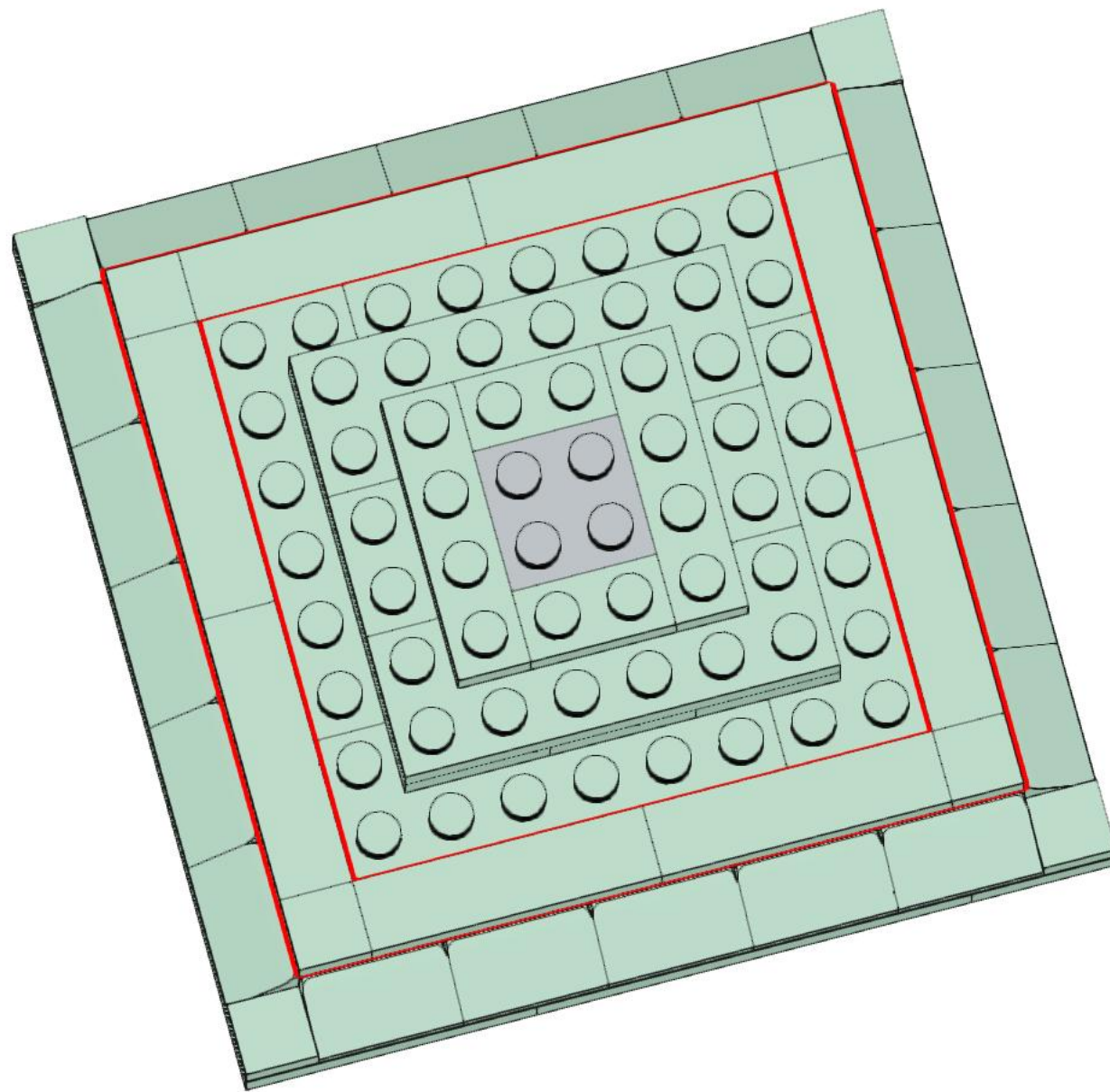
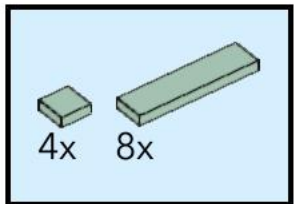

# 235

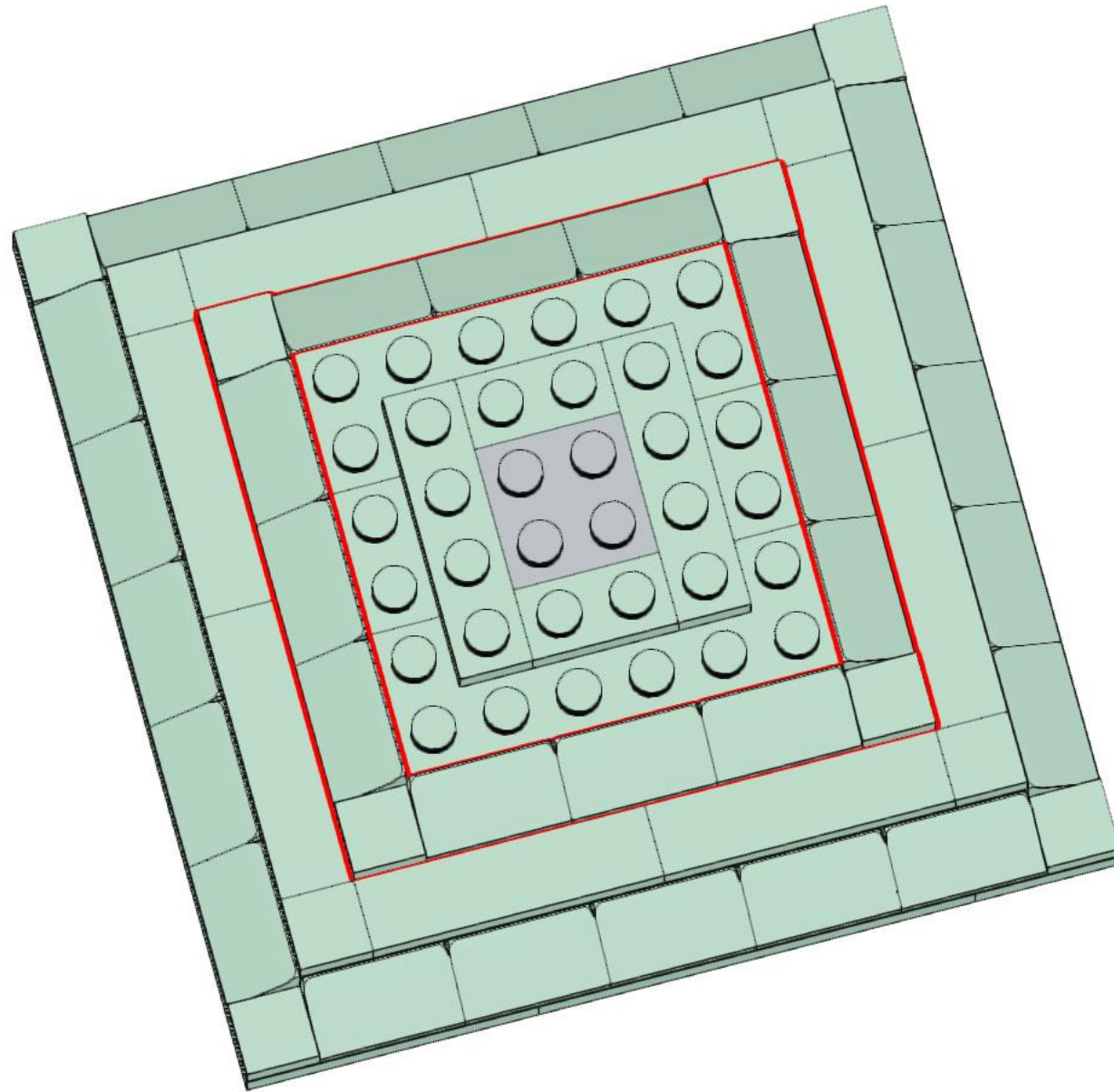
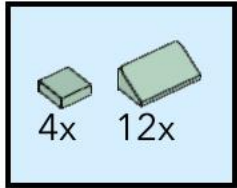

# 236

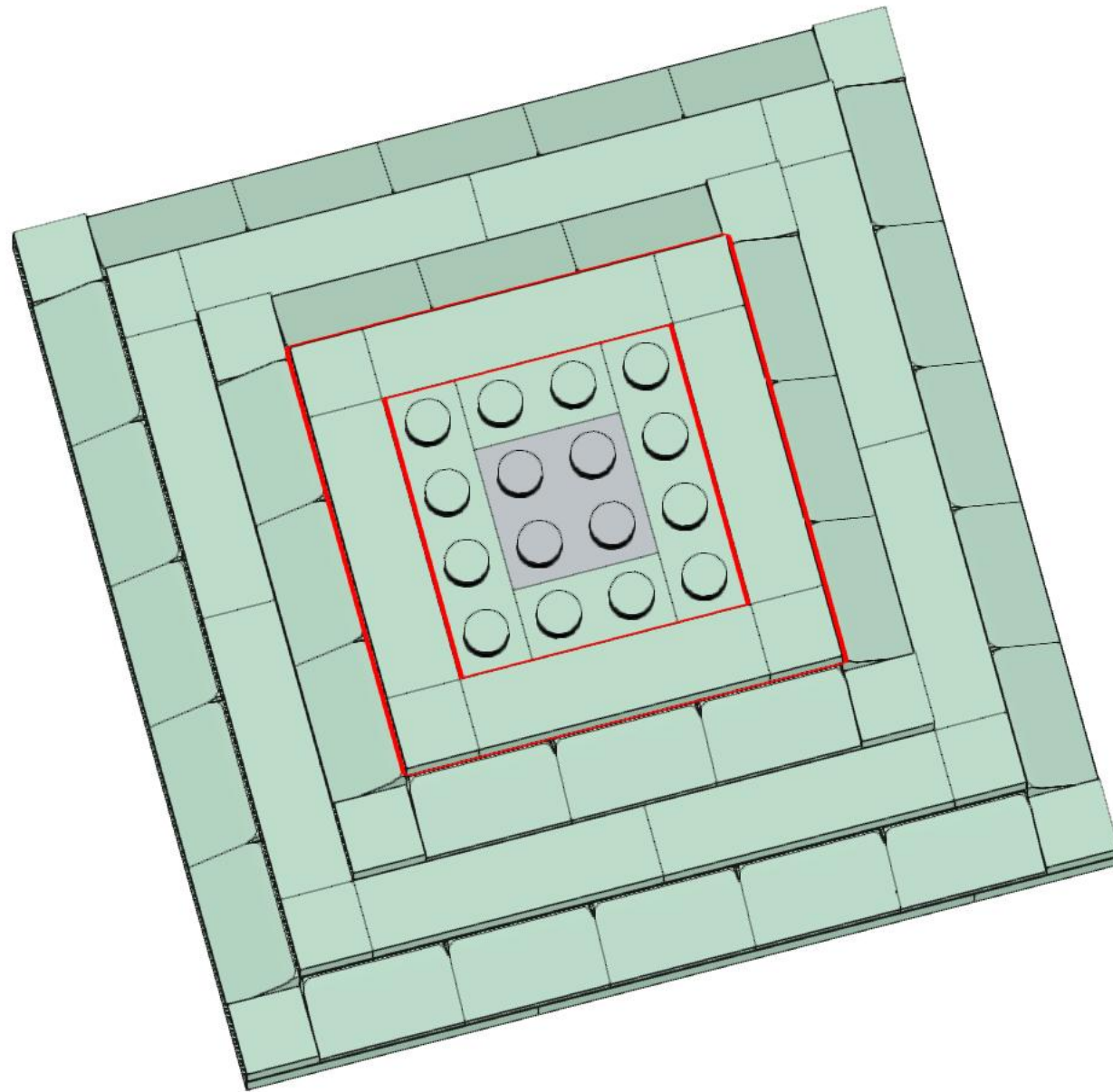
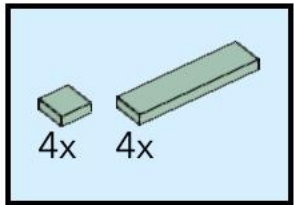

# 237

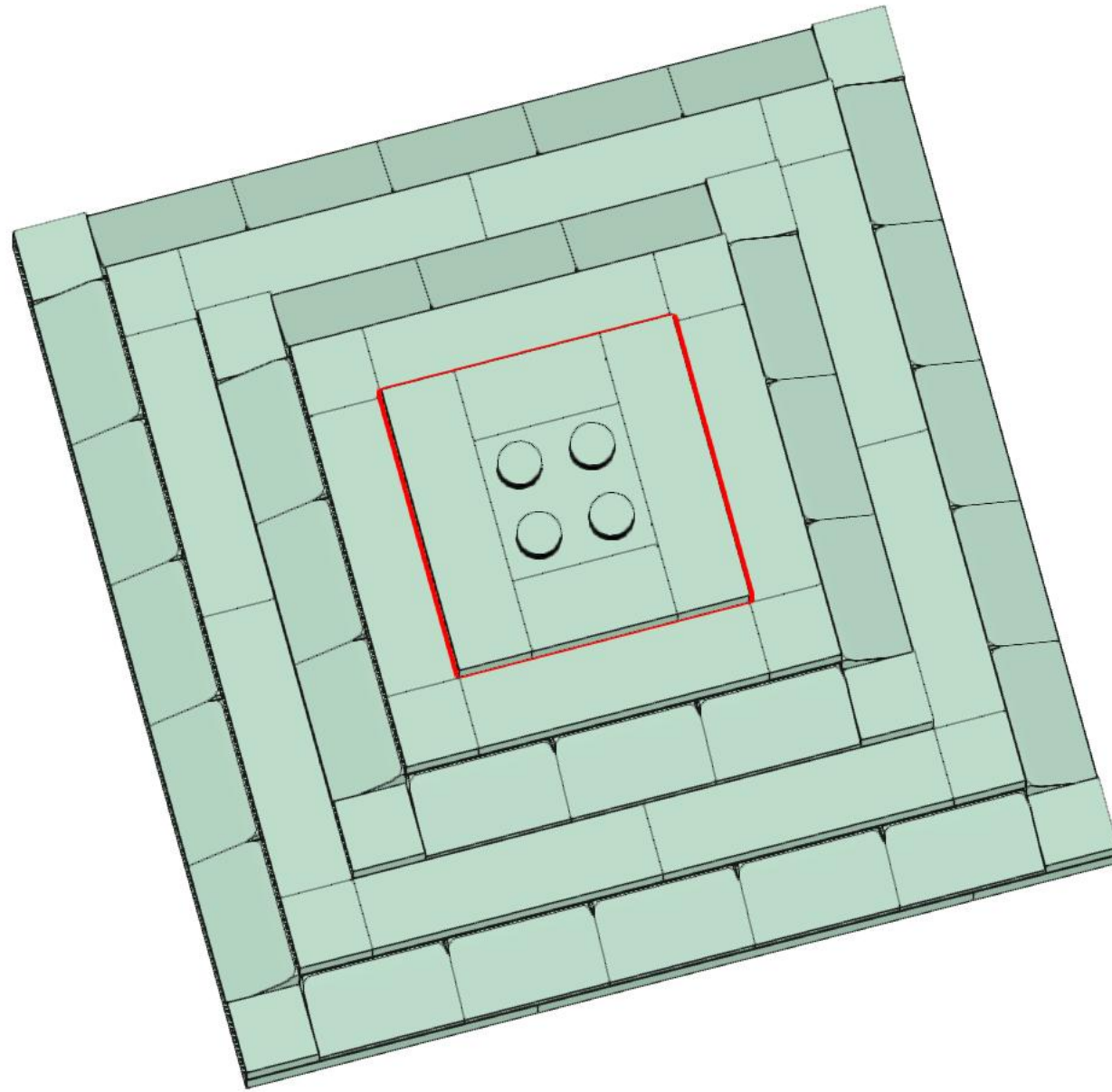
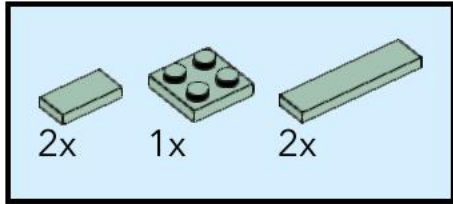

# 238

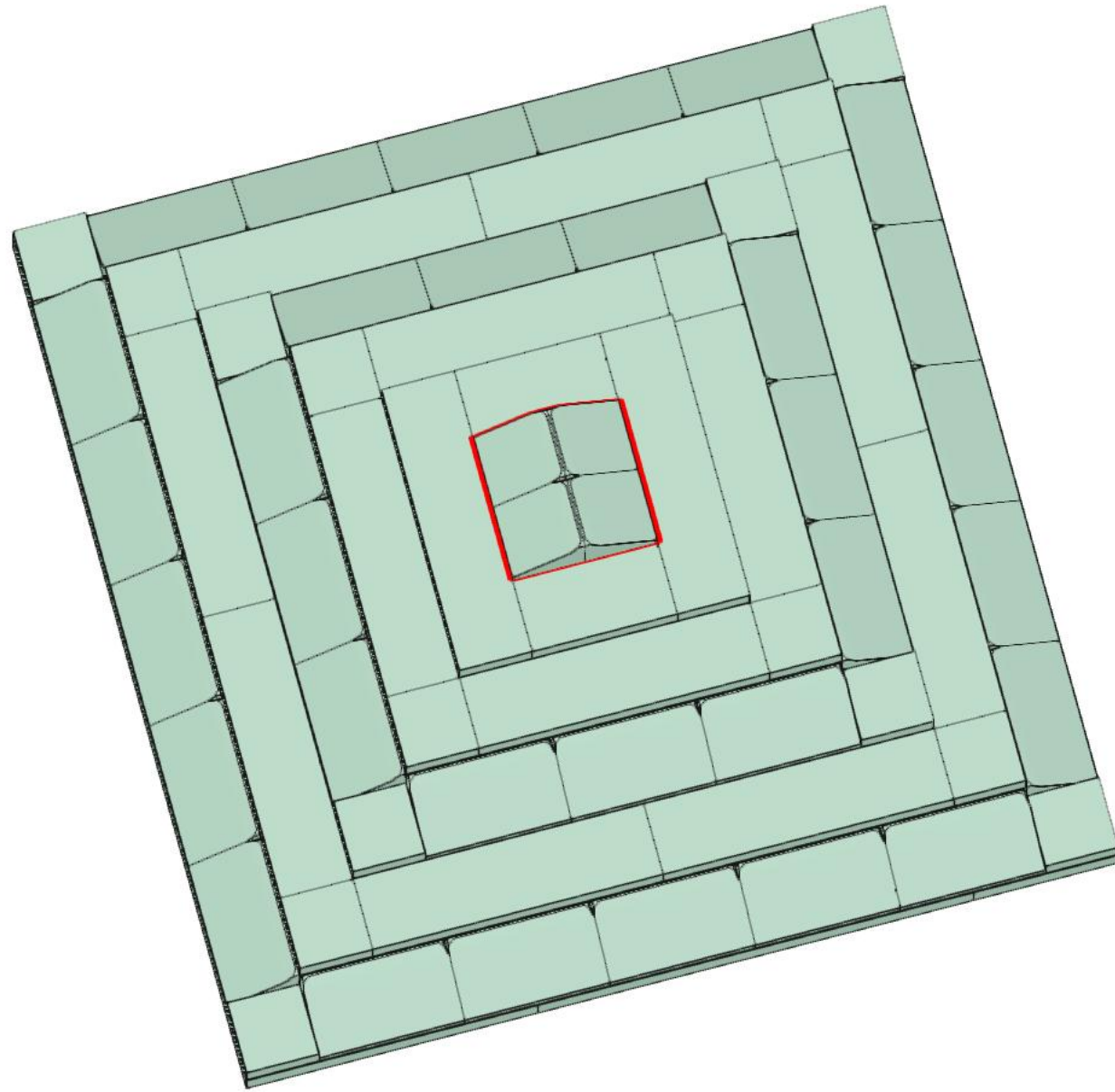
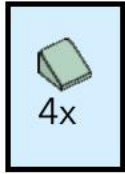

# 239

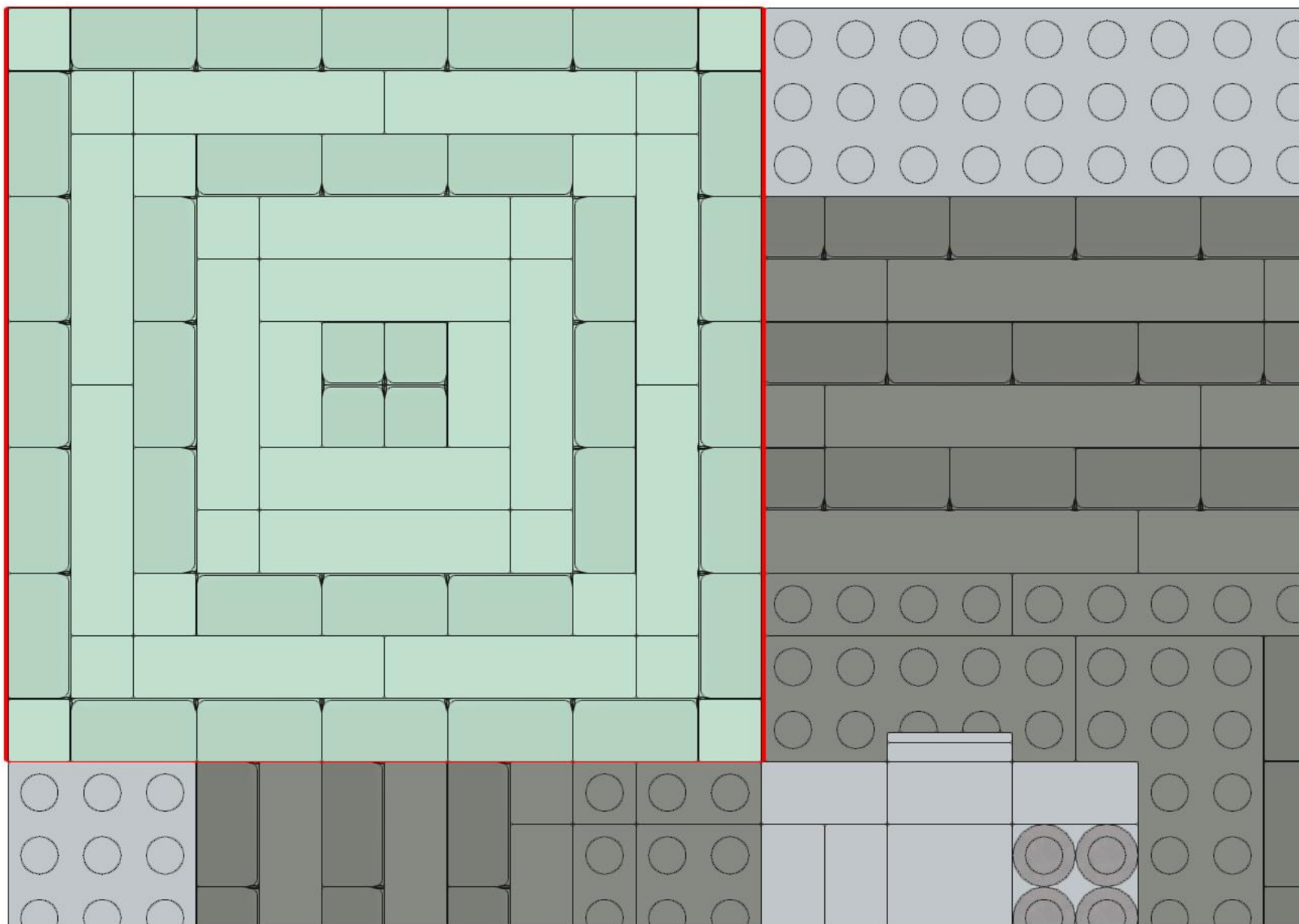



# 240

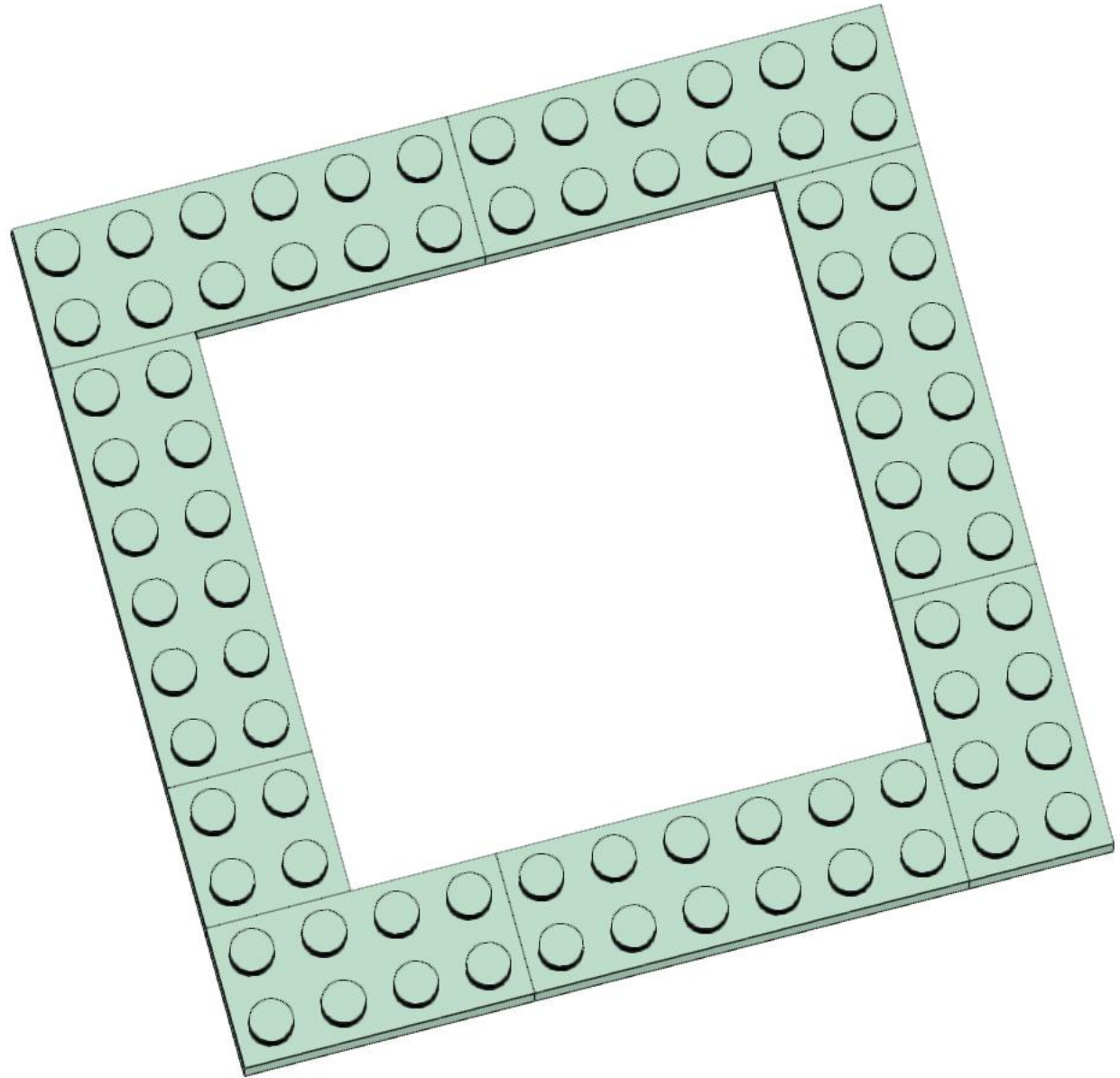
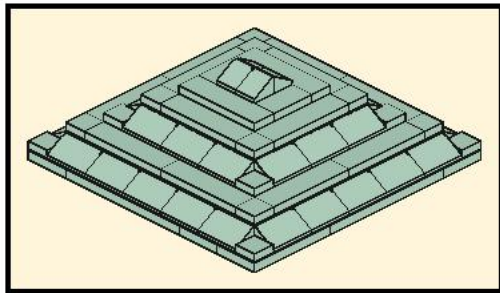
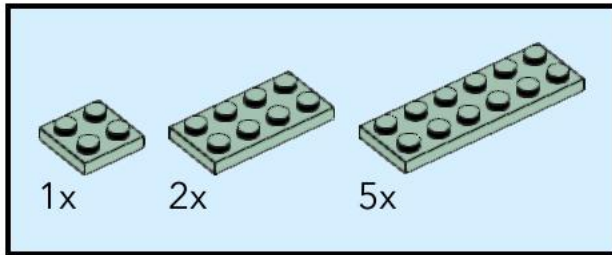

# 241

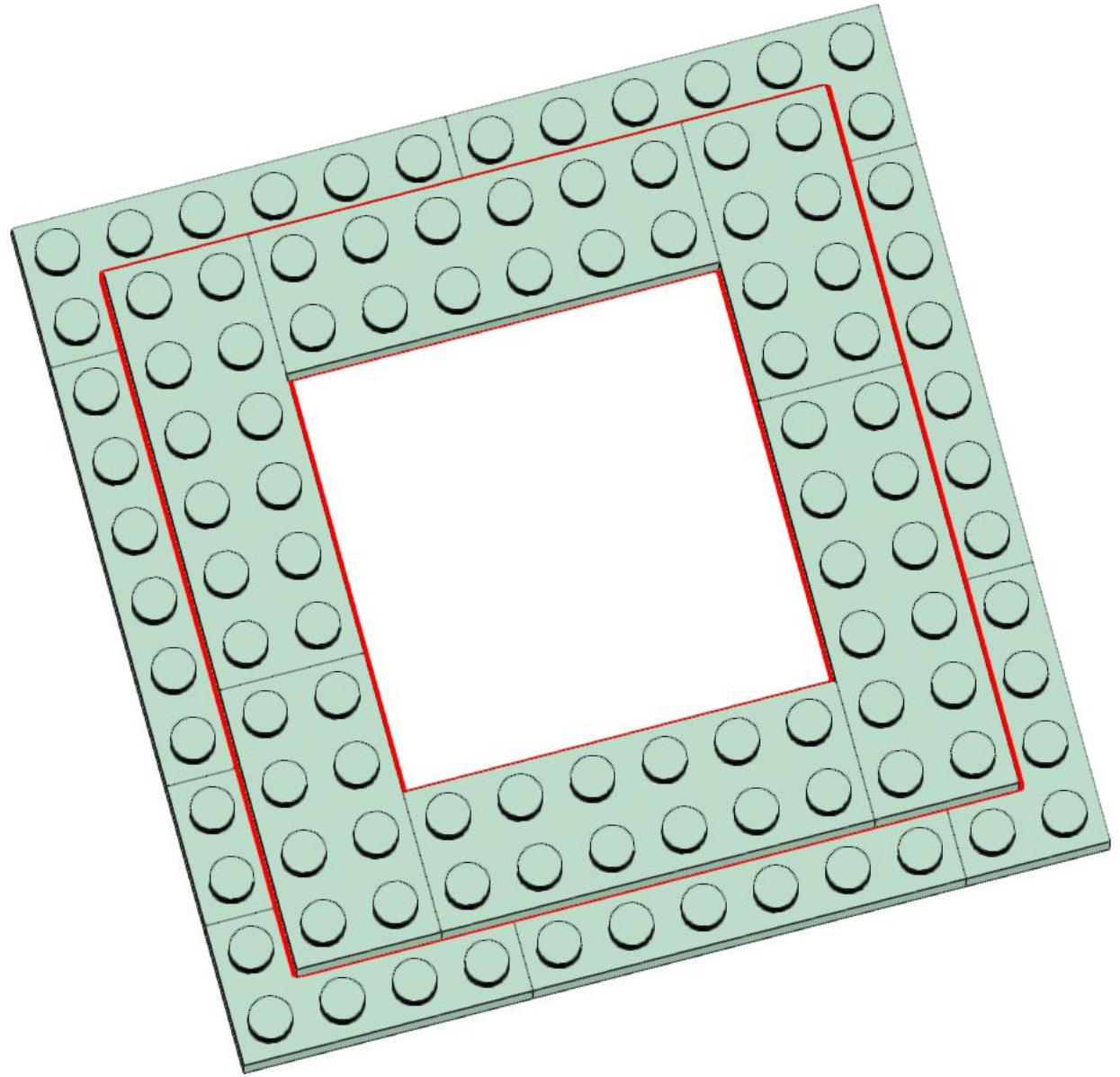
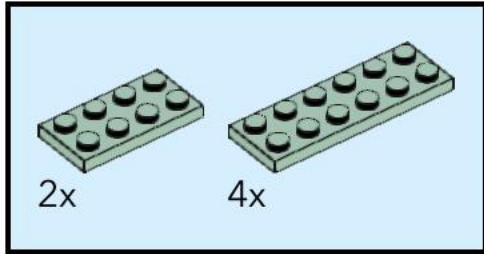

# 242

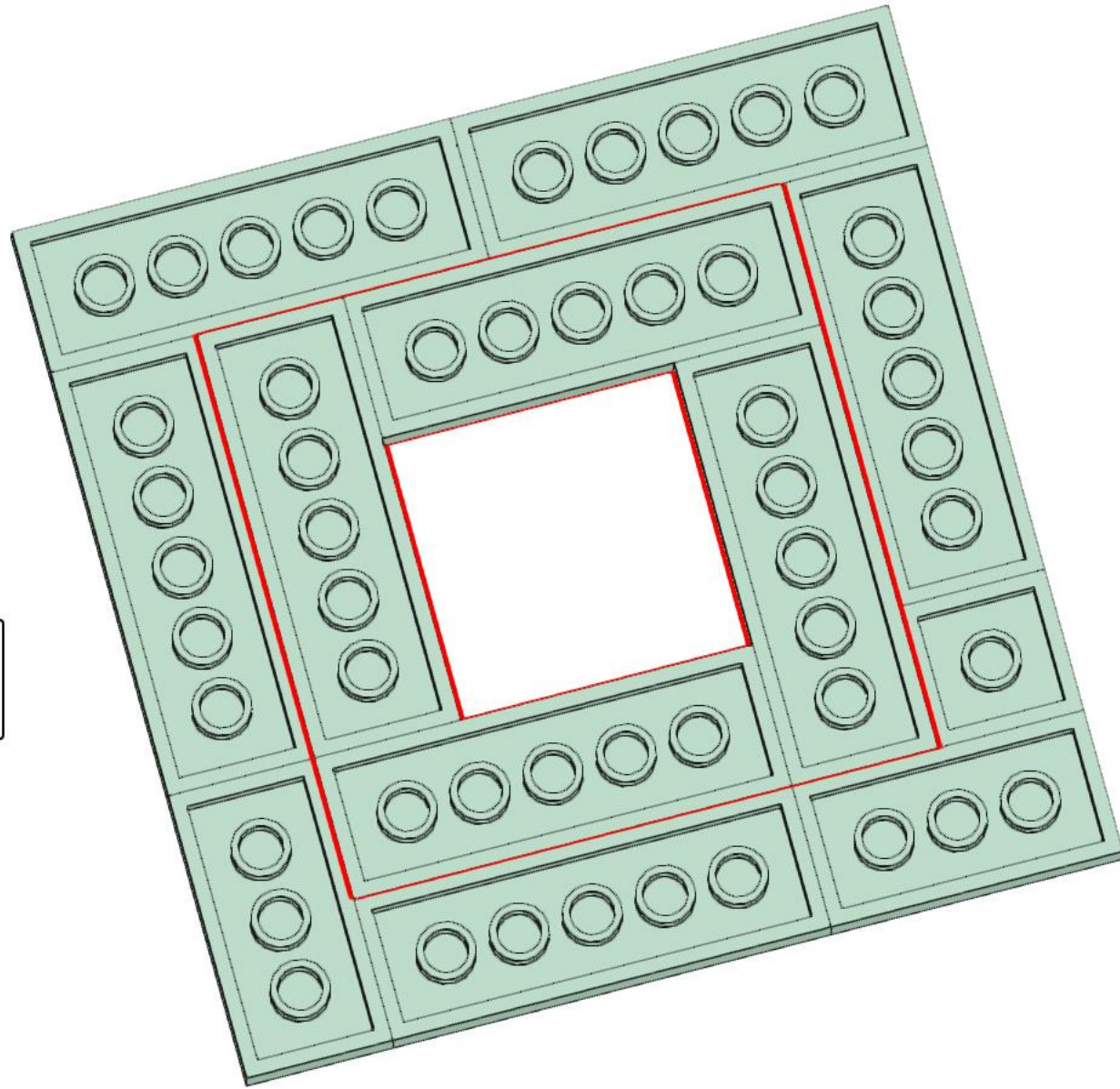
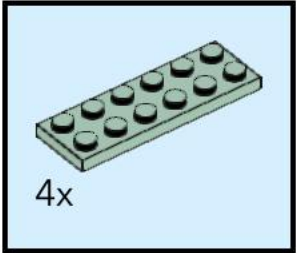

# 243

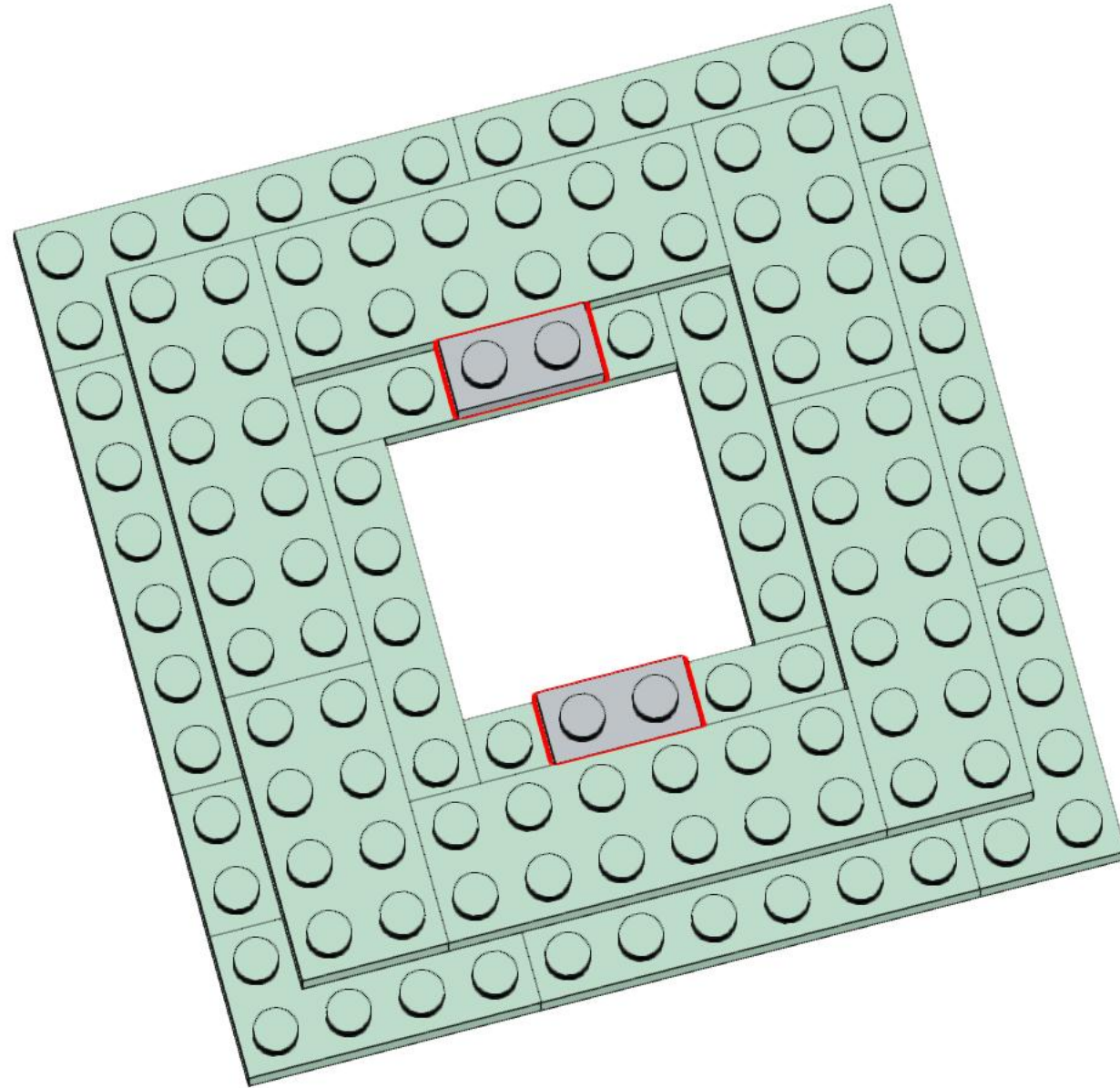
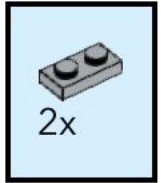

# 244

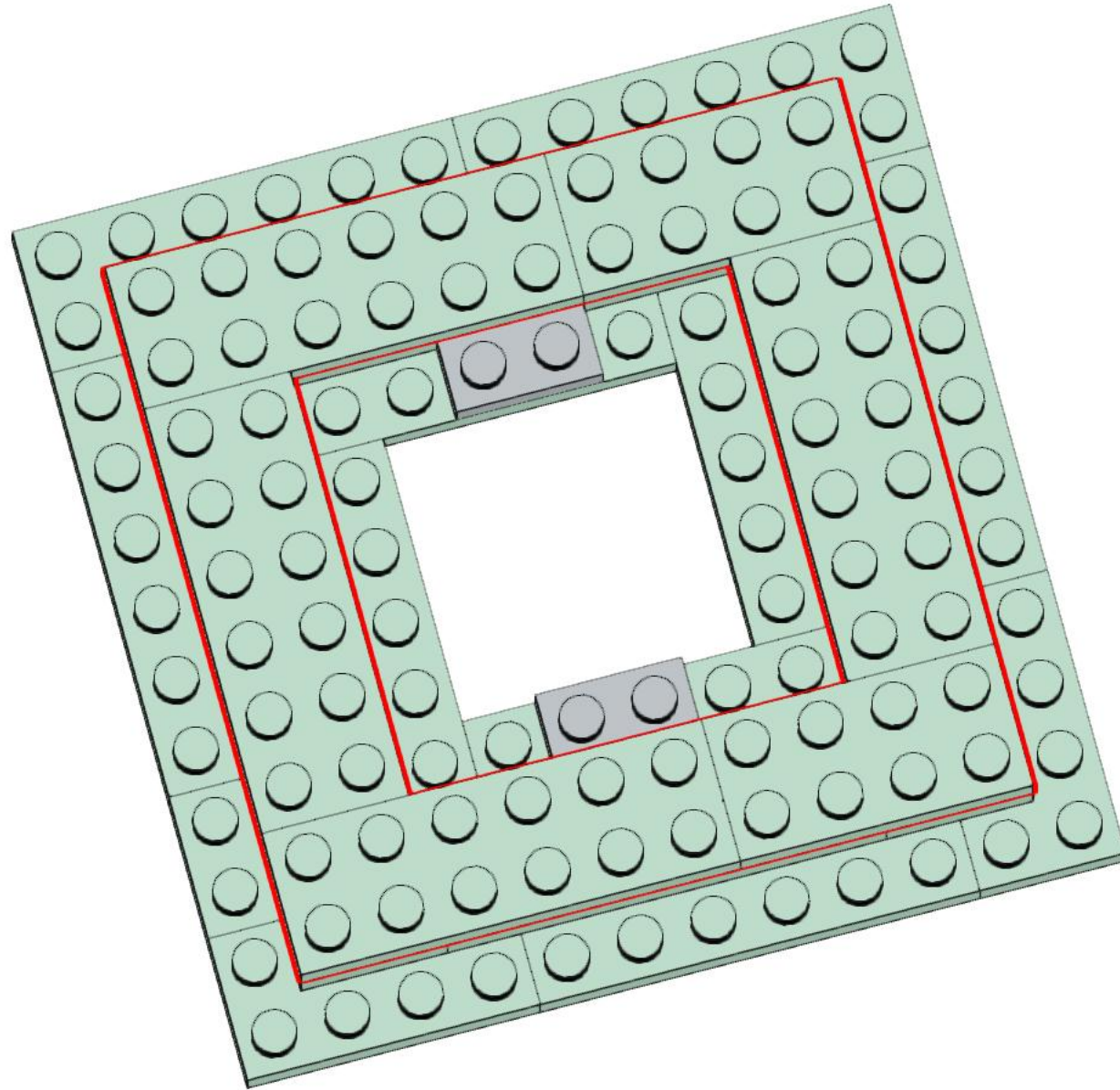
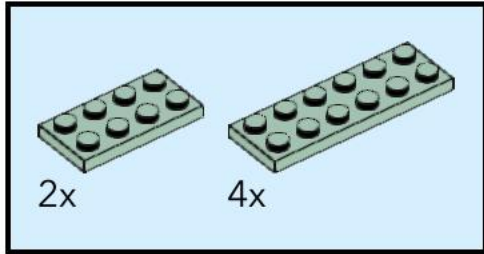

# 245

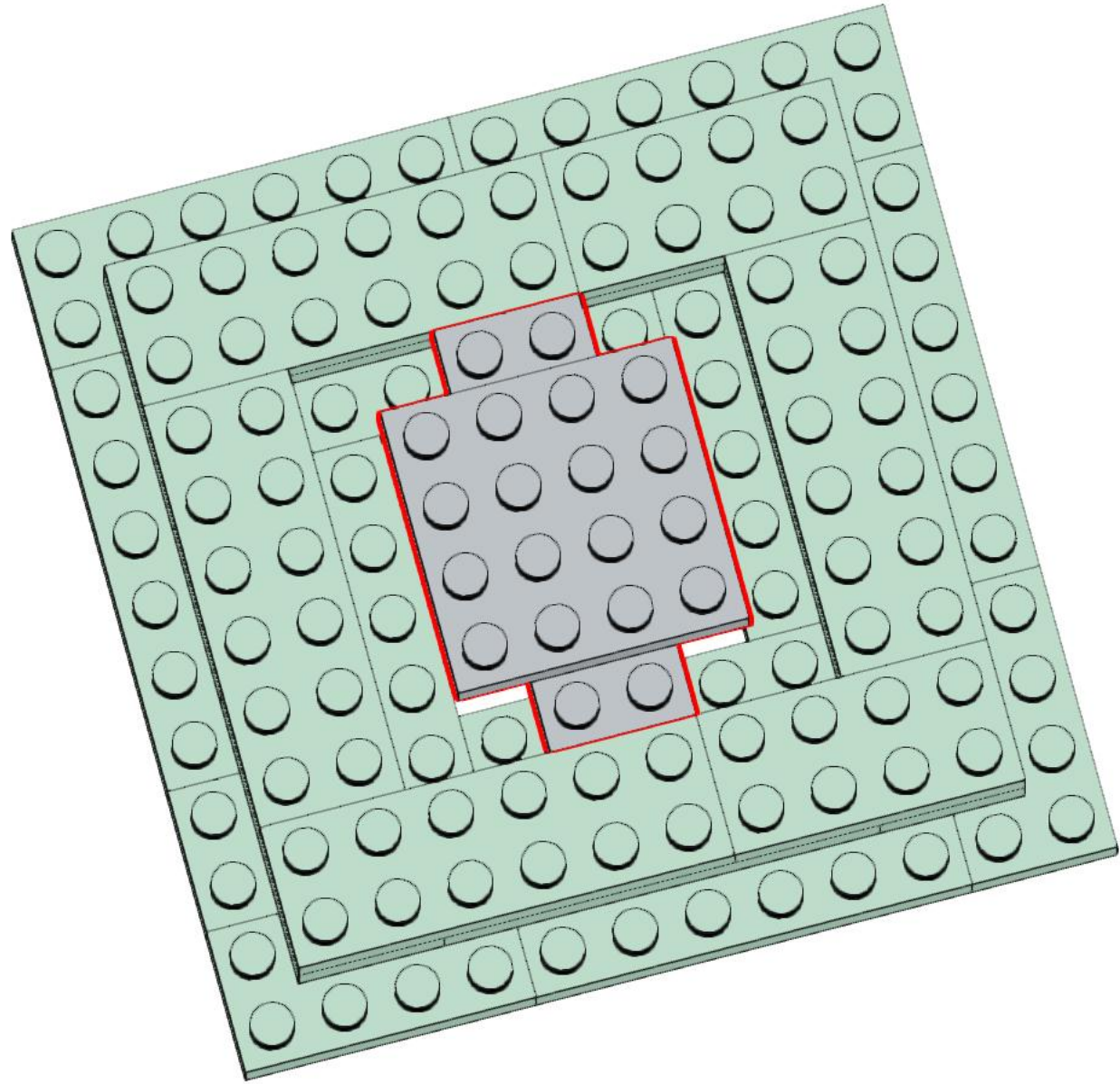
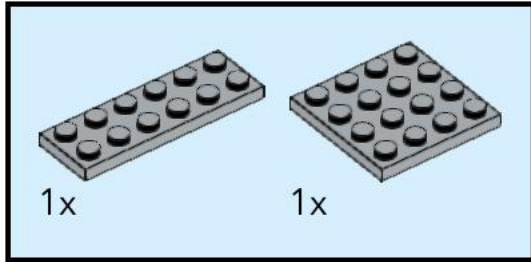

# 246

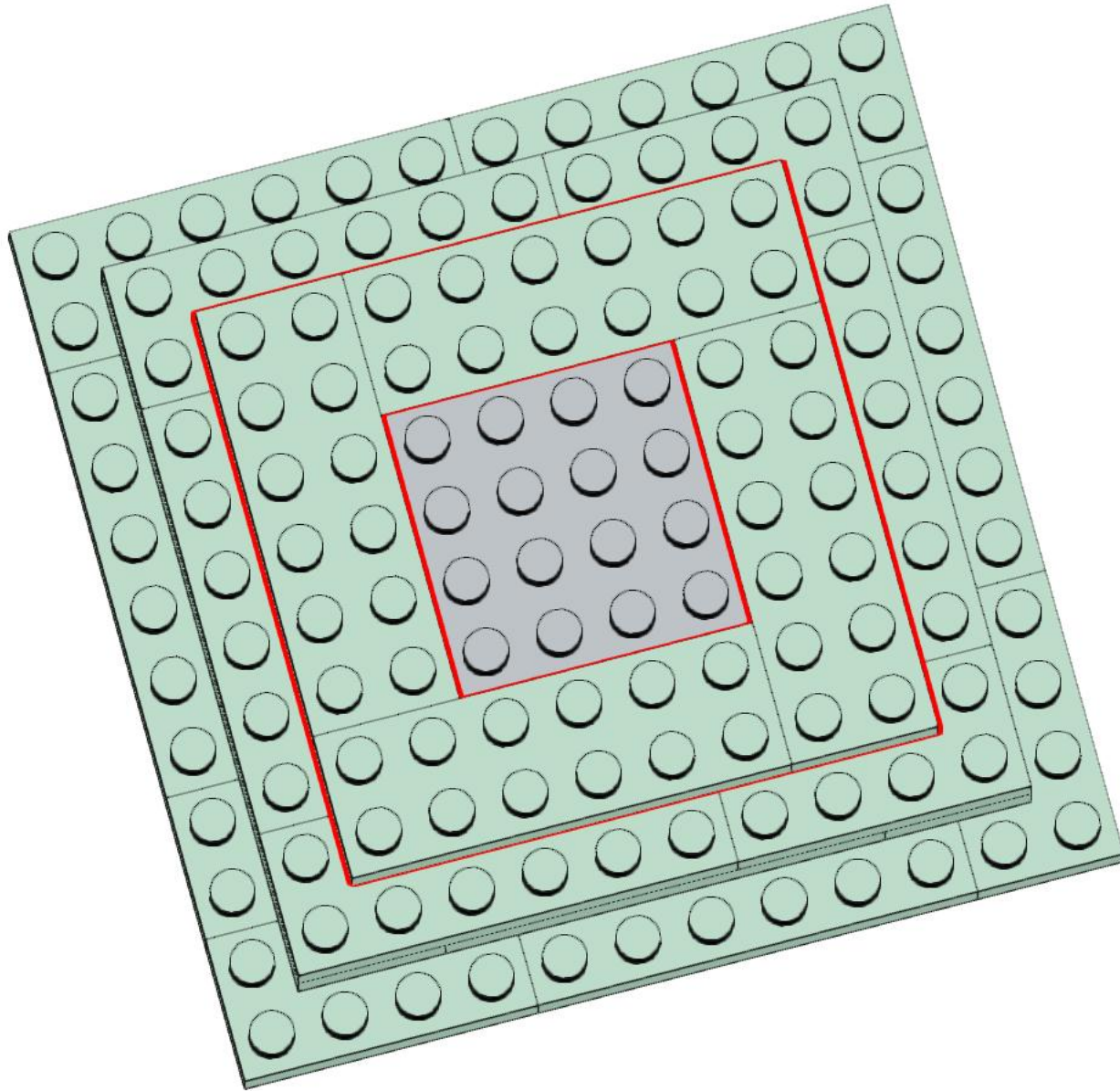
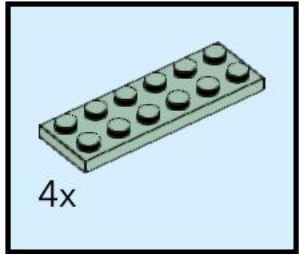

# 247

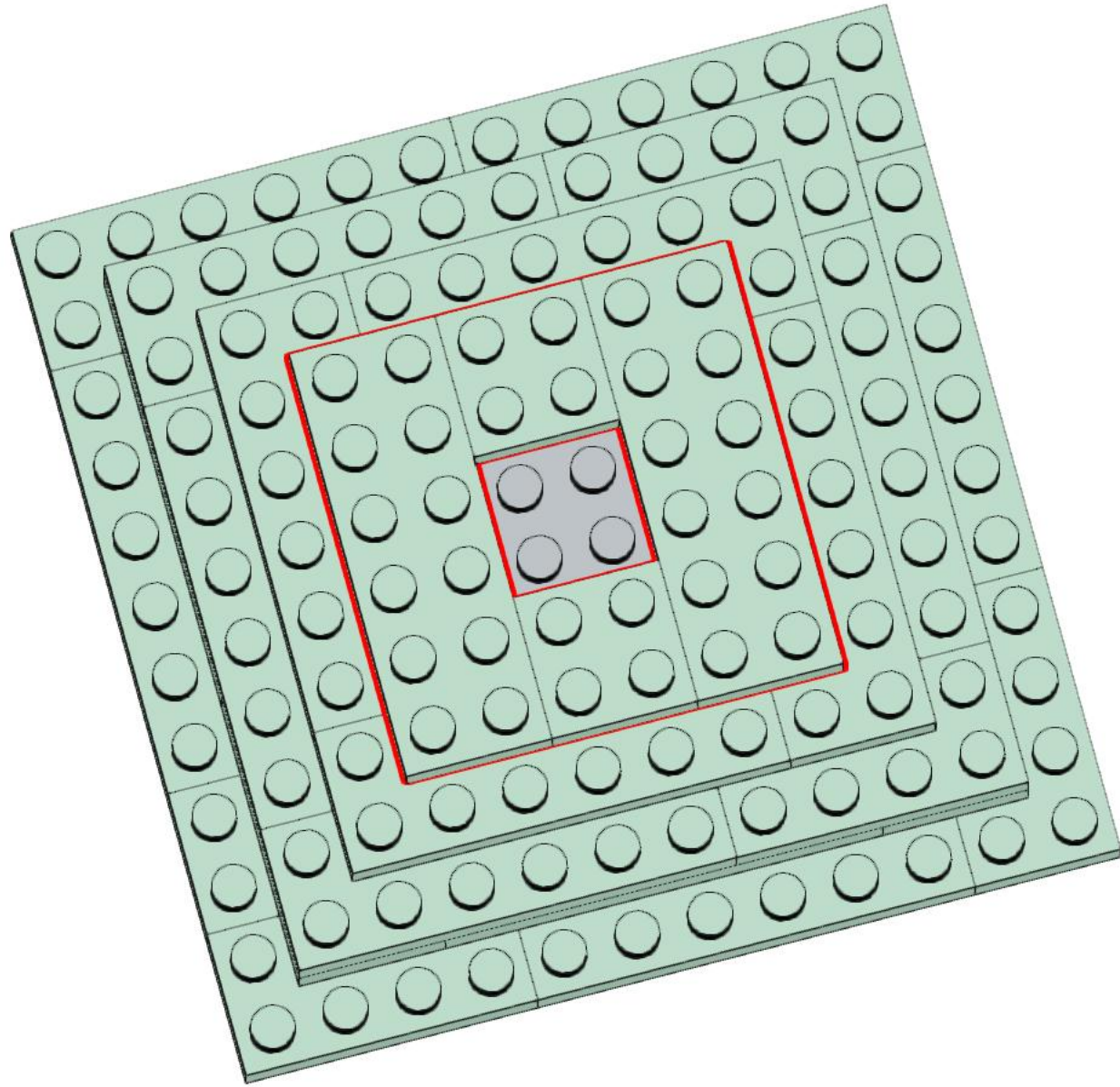
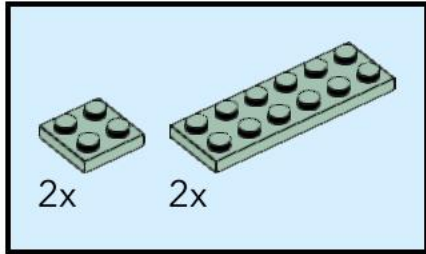



# 248

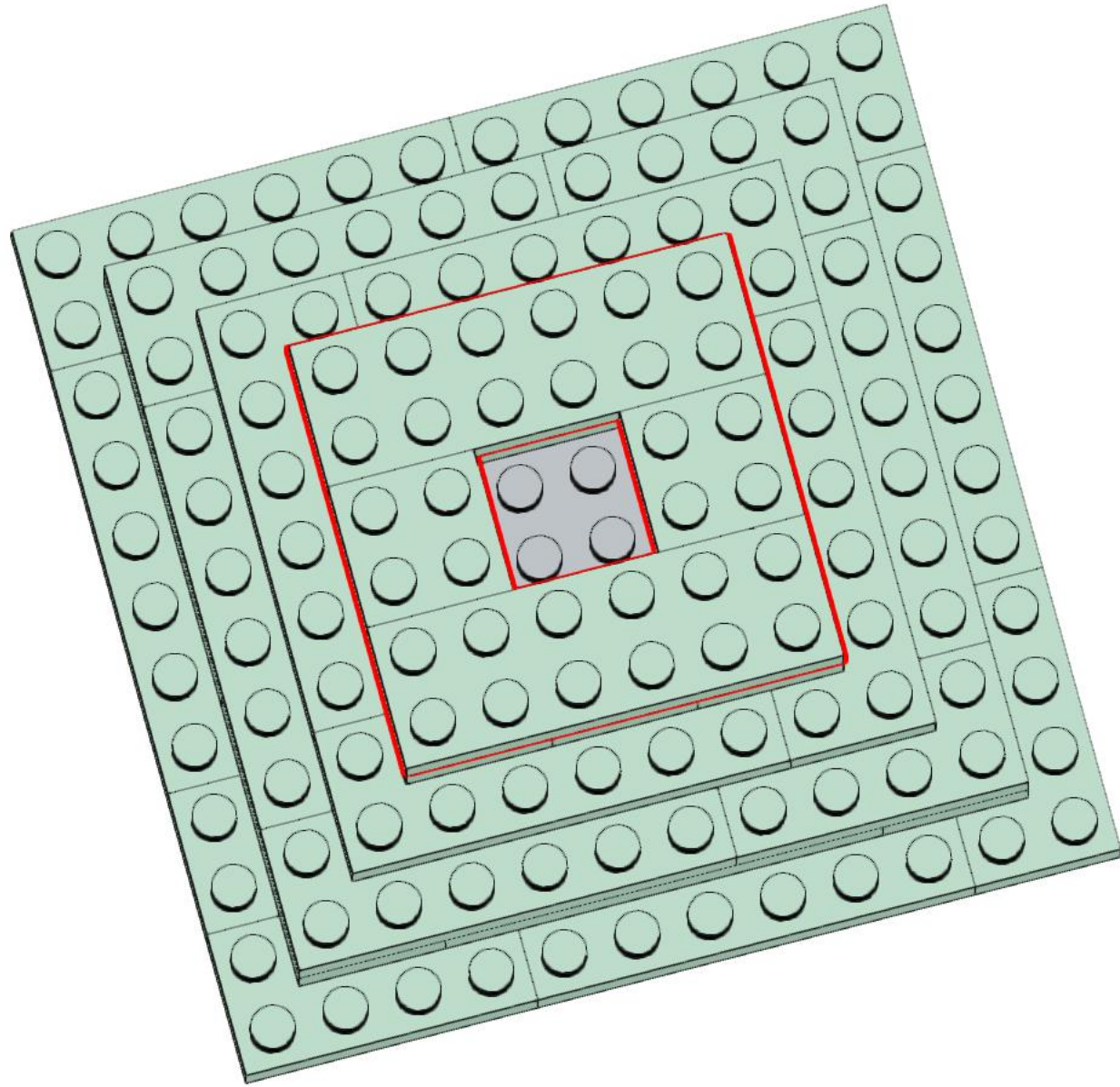
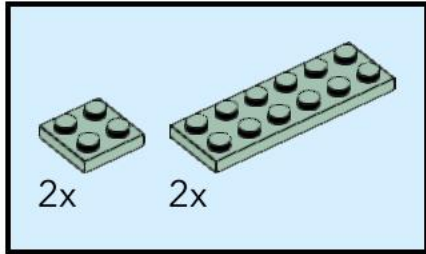

# 249

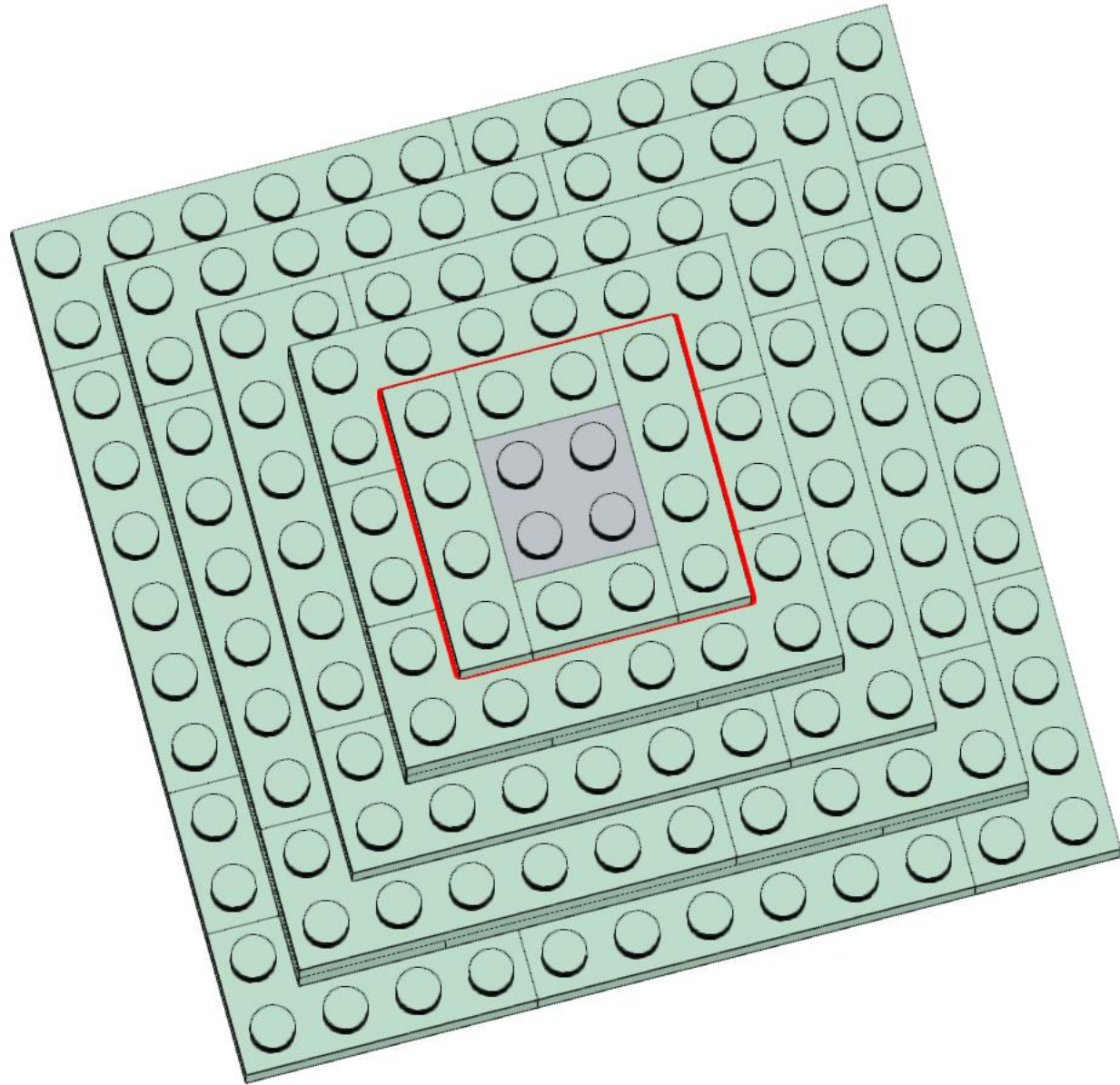
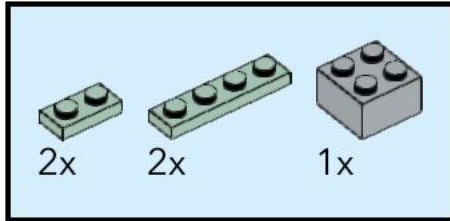

# 250

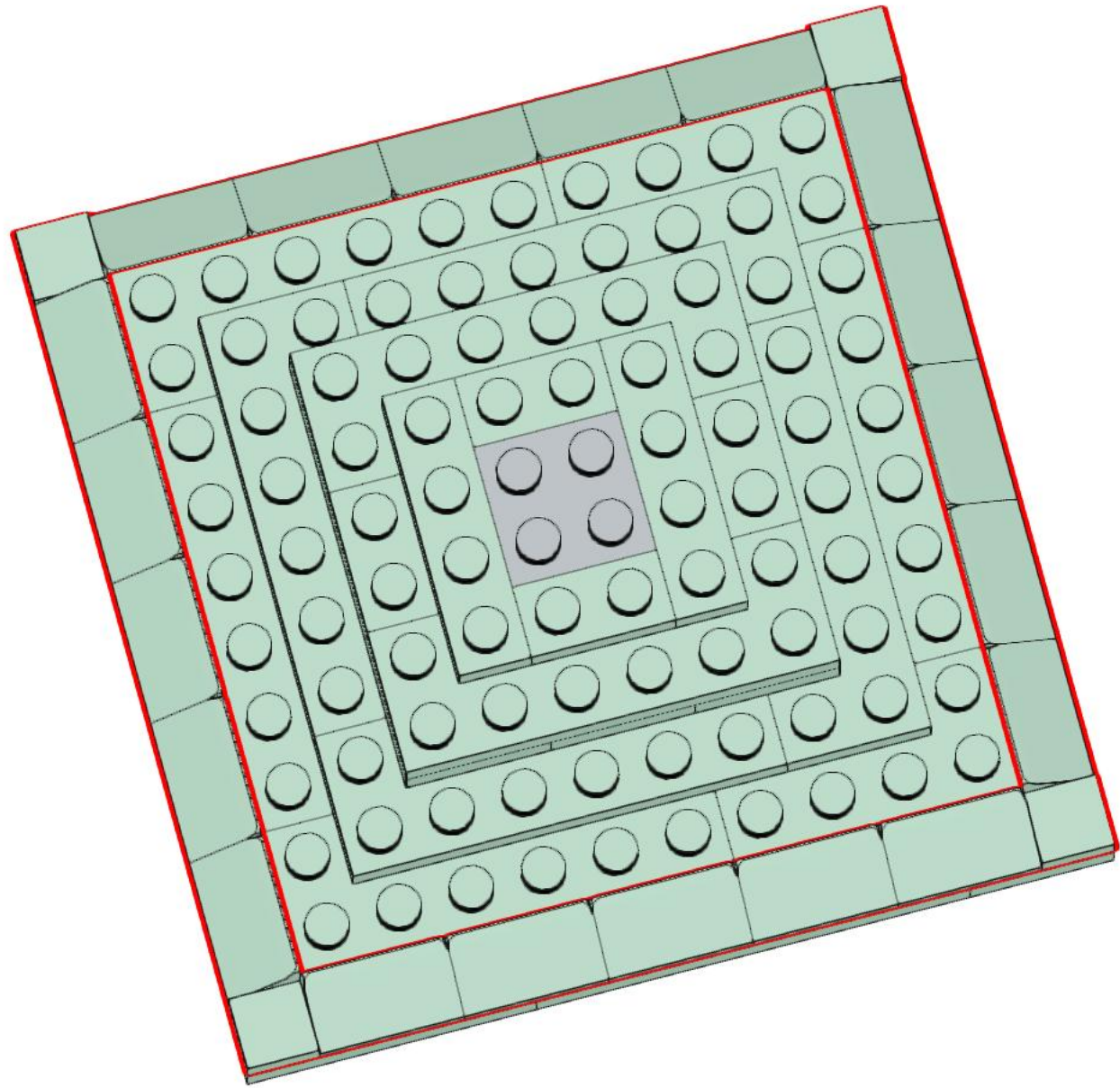
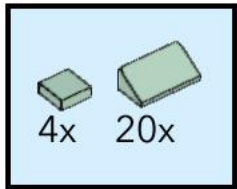

# 251

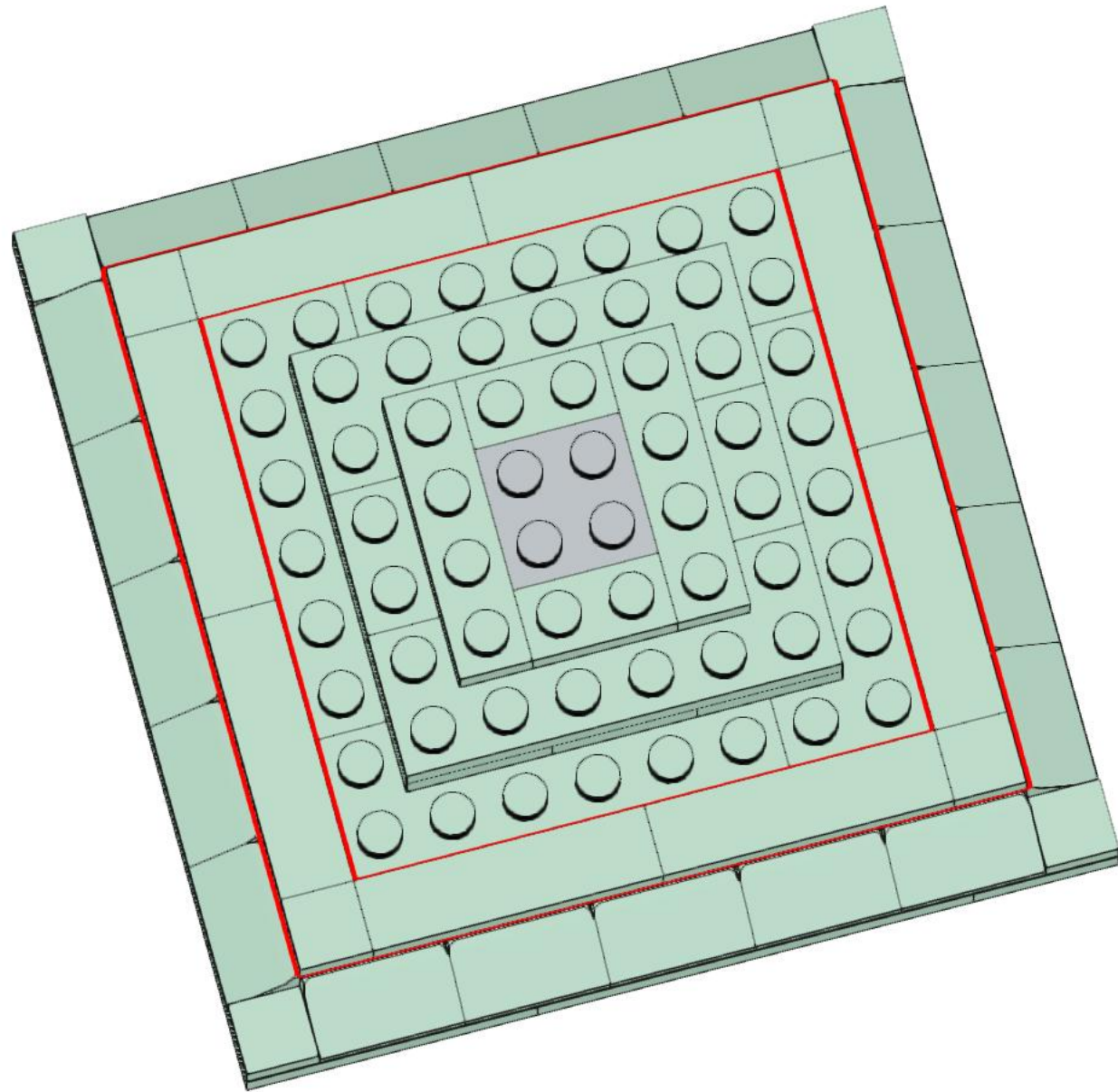
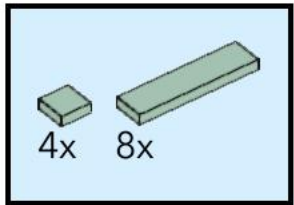

# 252

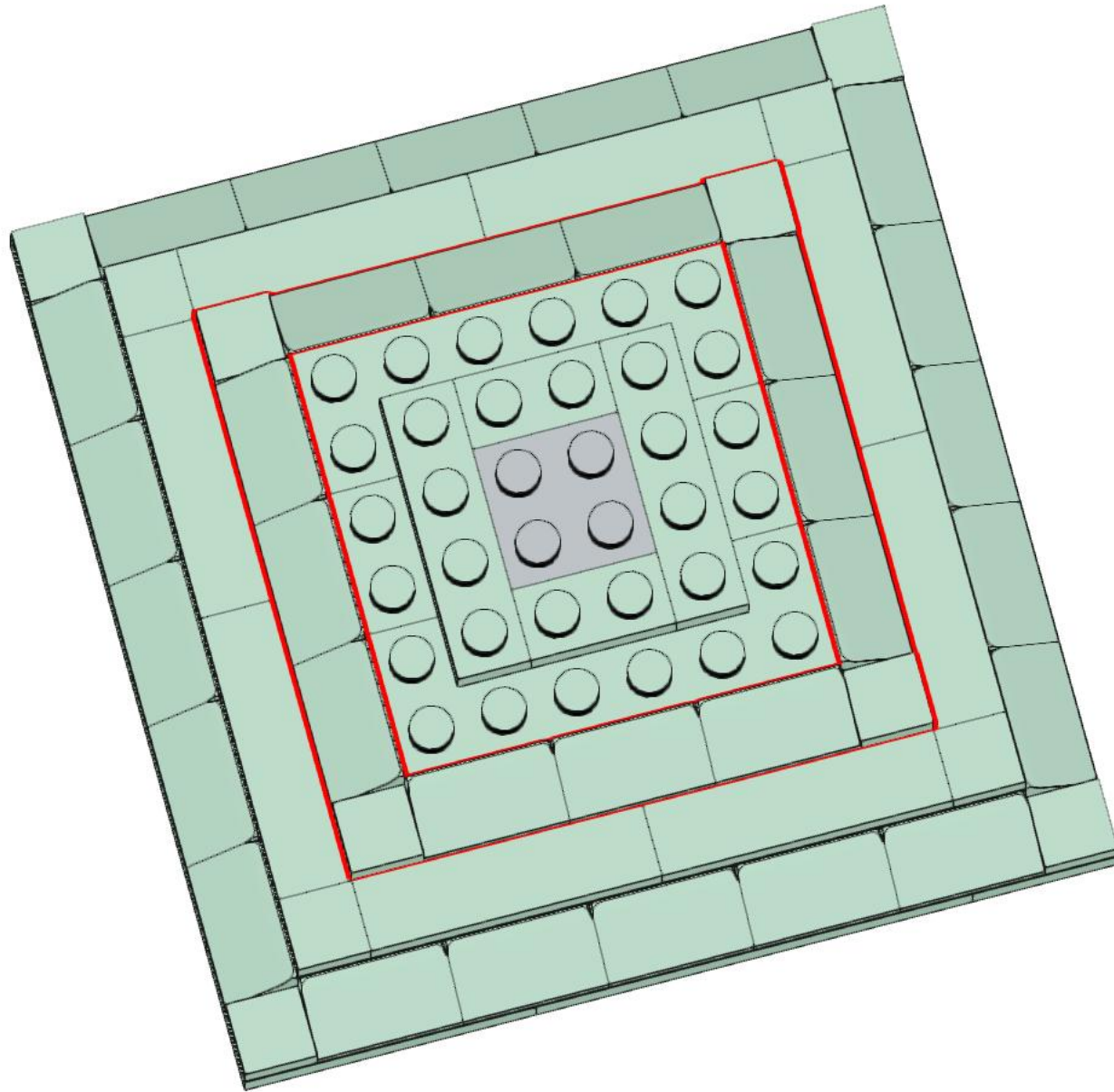
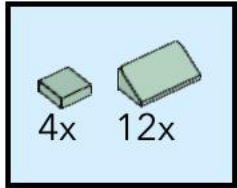

# 253

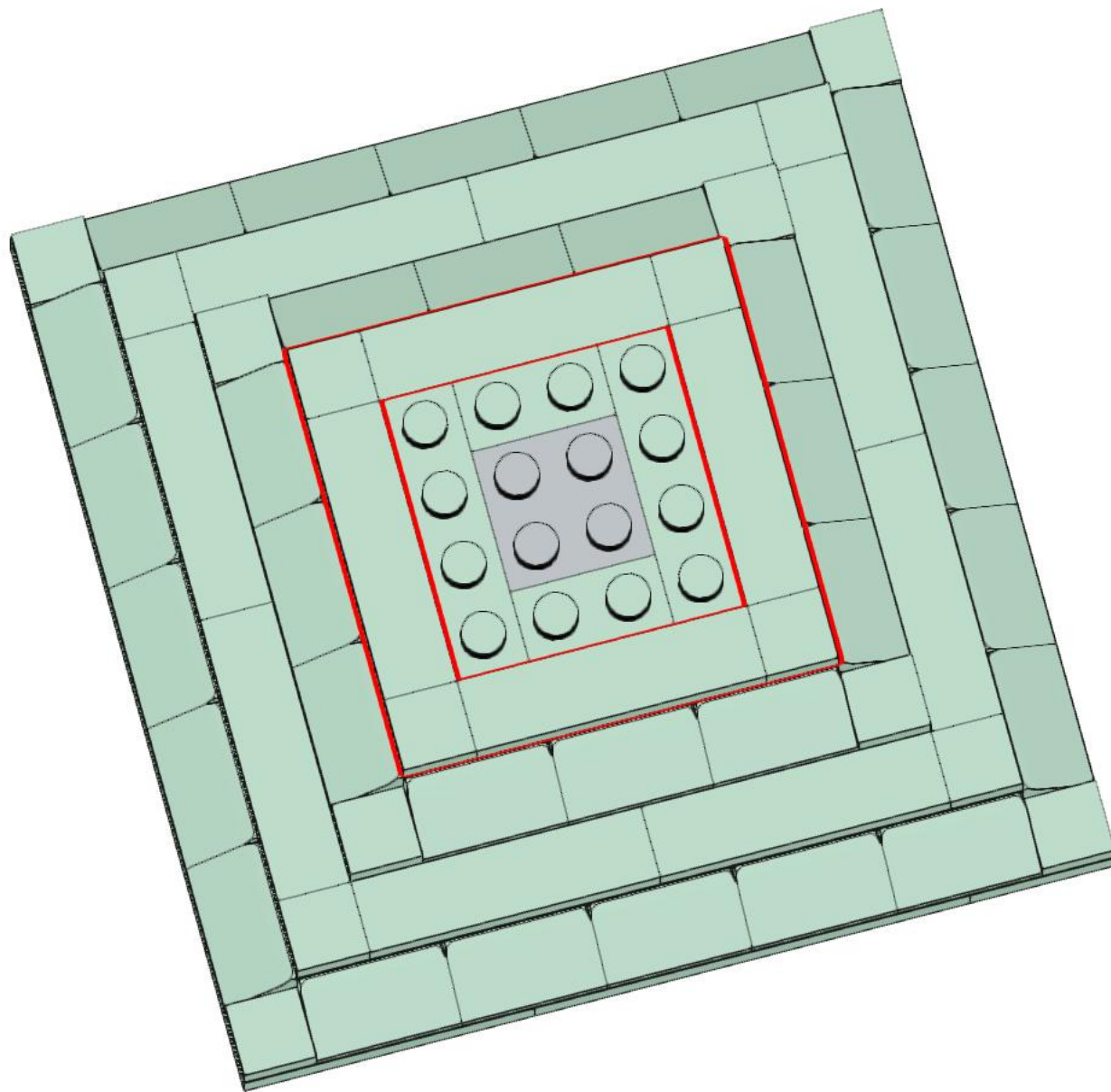
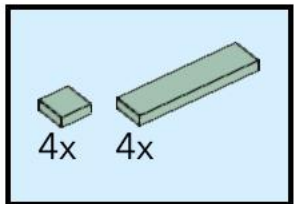

# 254

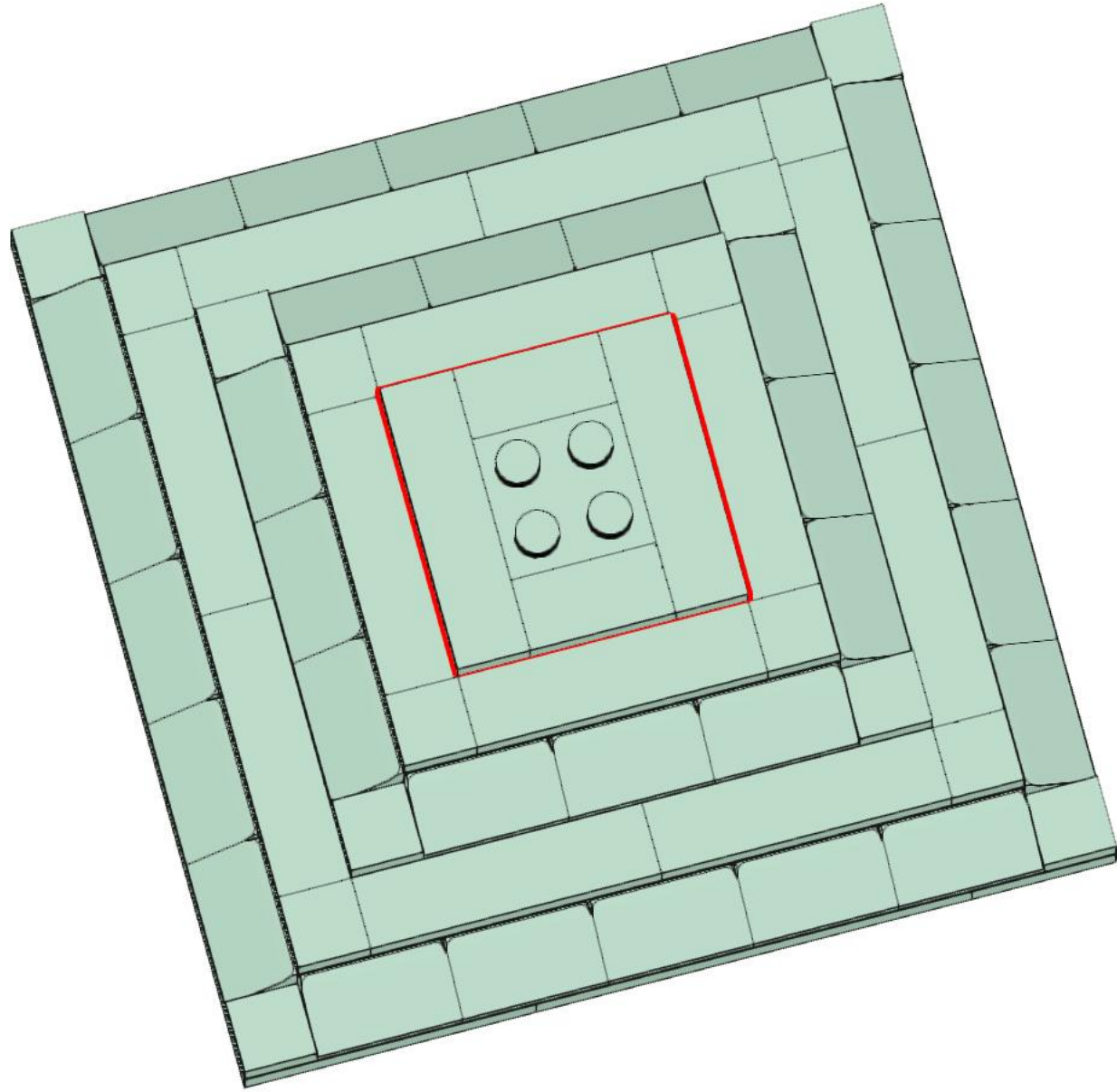
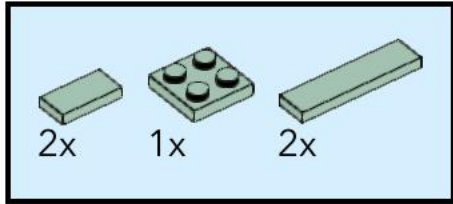

# 255

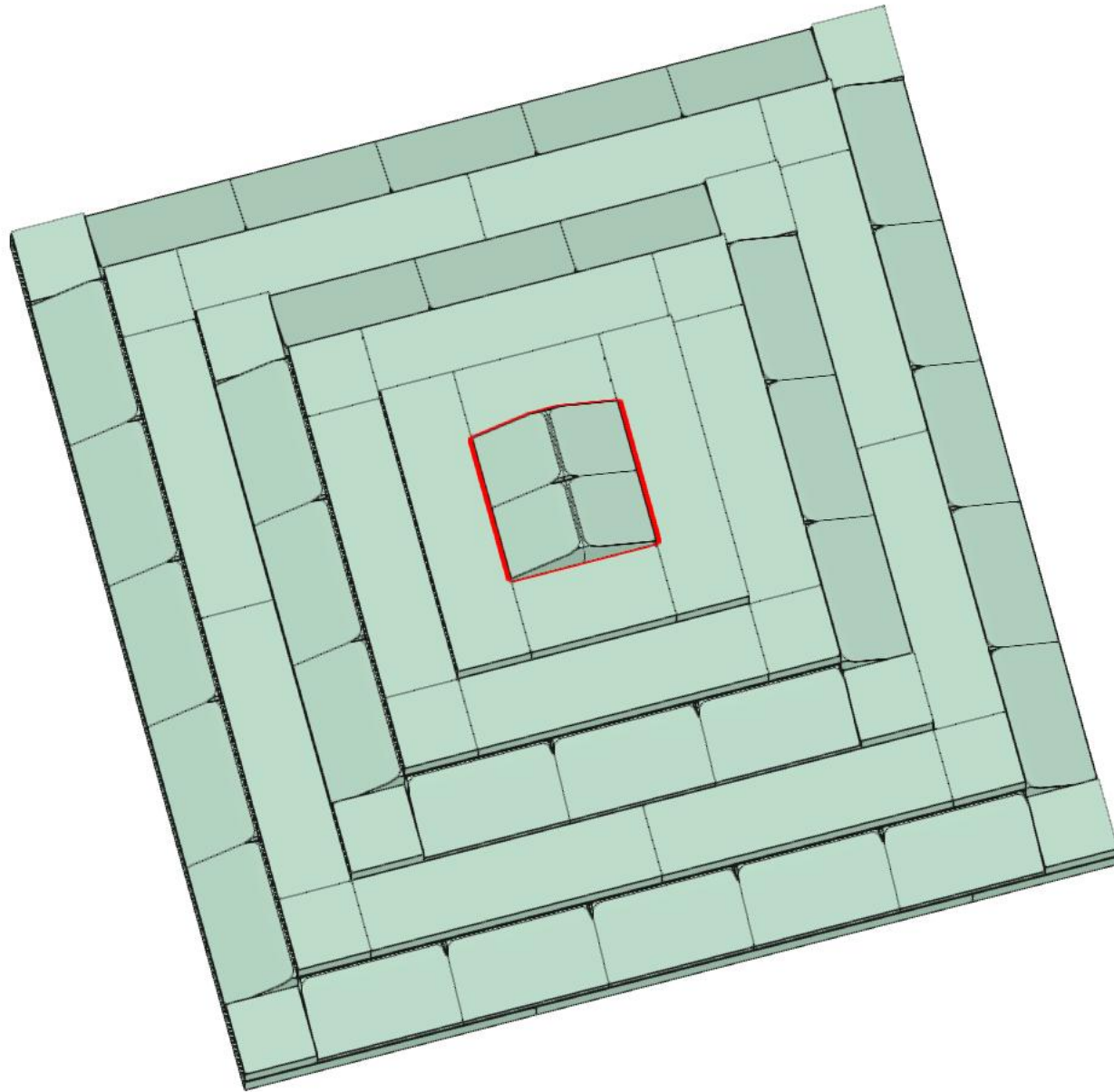
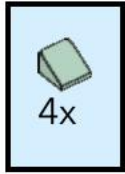



256

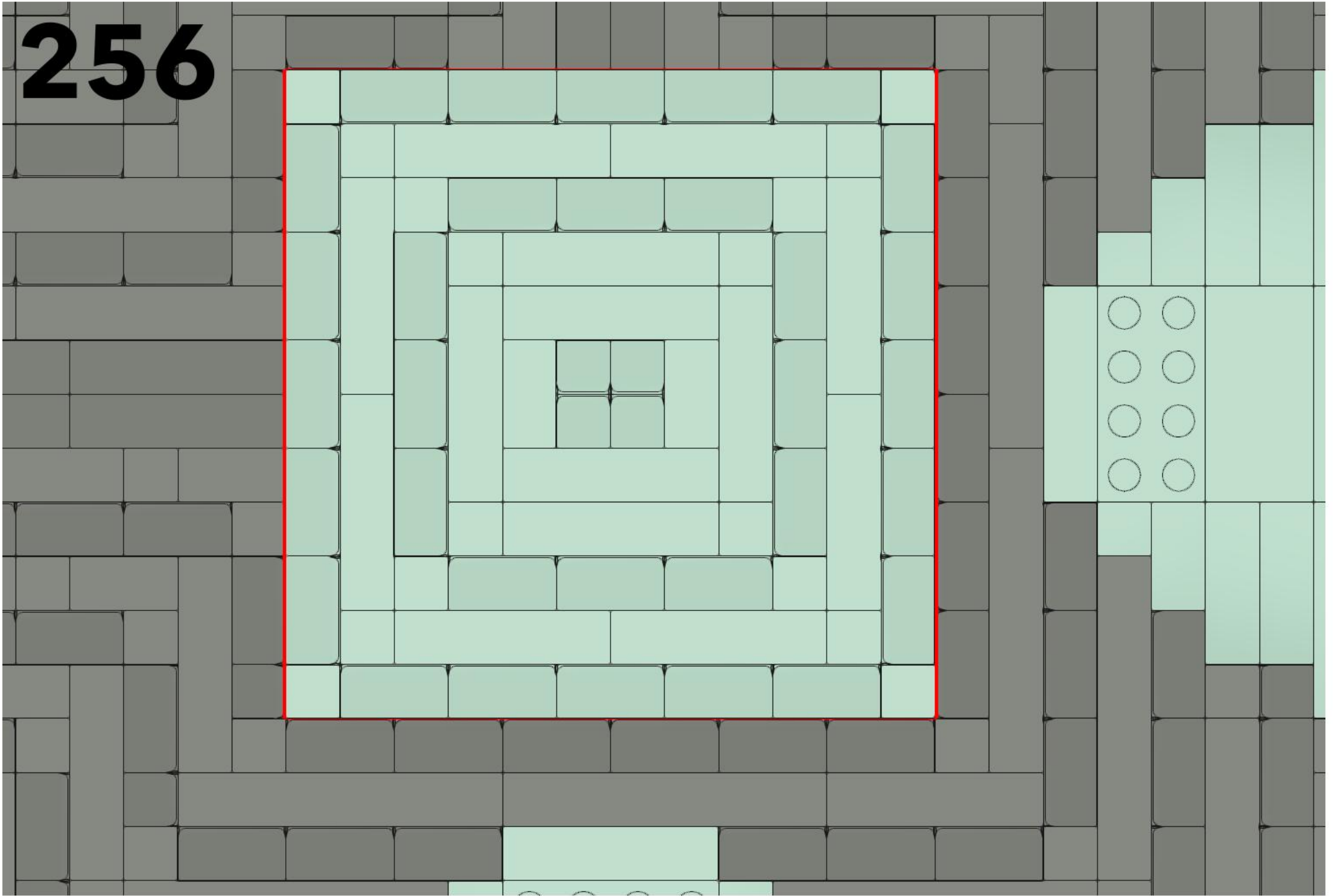

# 257

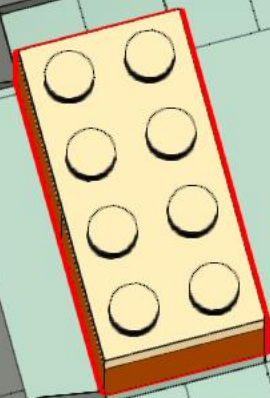
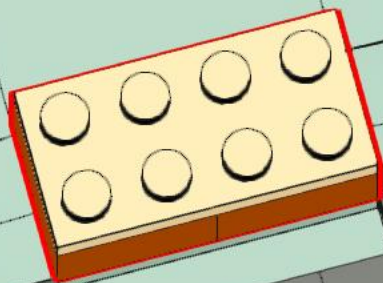
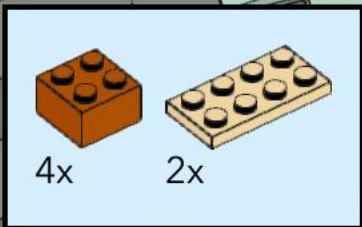

# 258



4x  
12x

This inset box shows the parts required for step 258. On the left is a grey circular tile, and on the right is a brown, multi-layered cylindrical component. The quantities '4x' and '12x' are listed below each respective part.

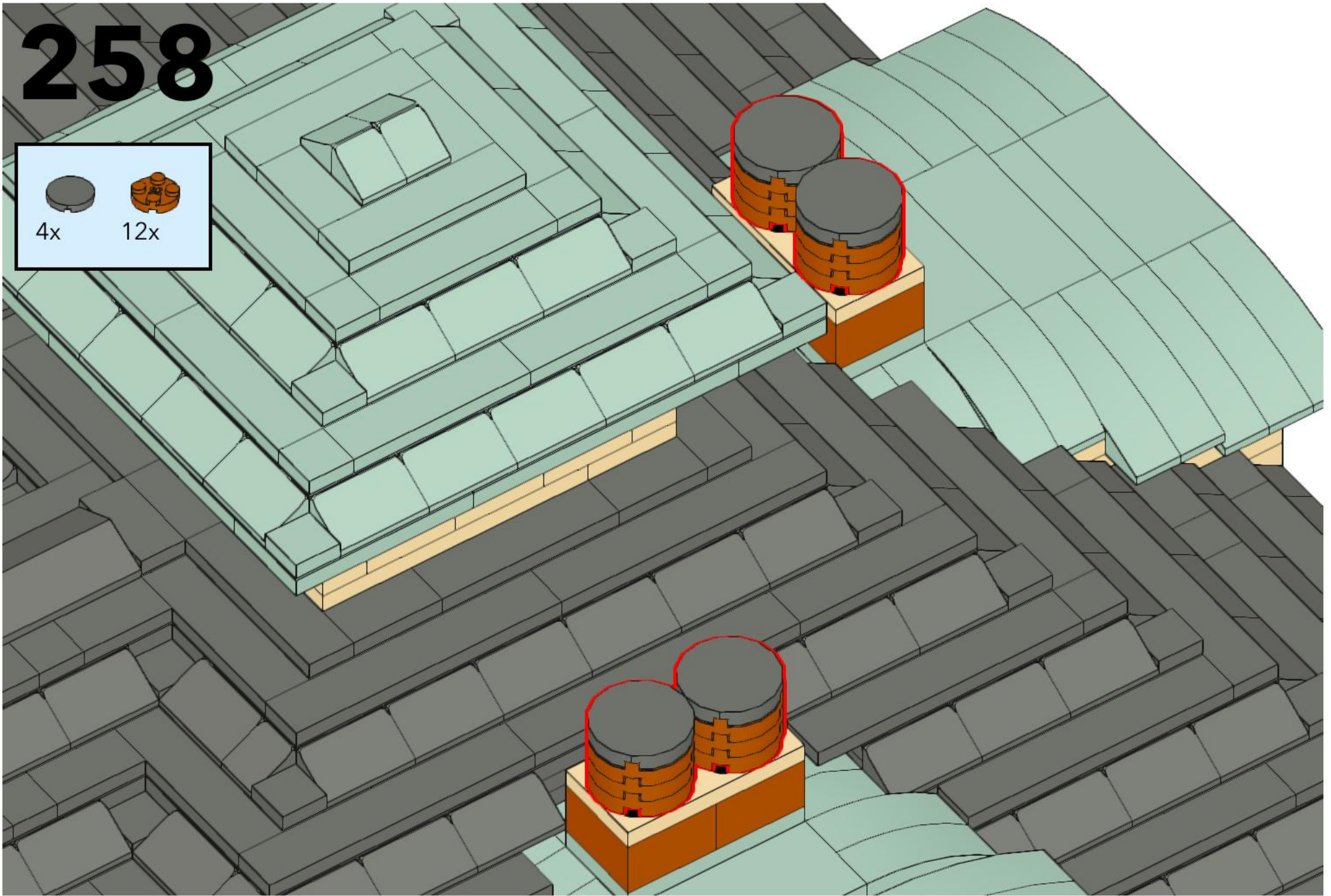

# 259



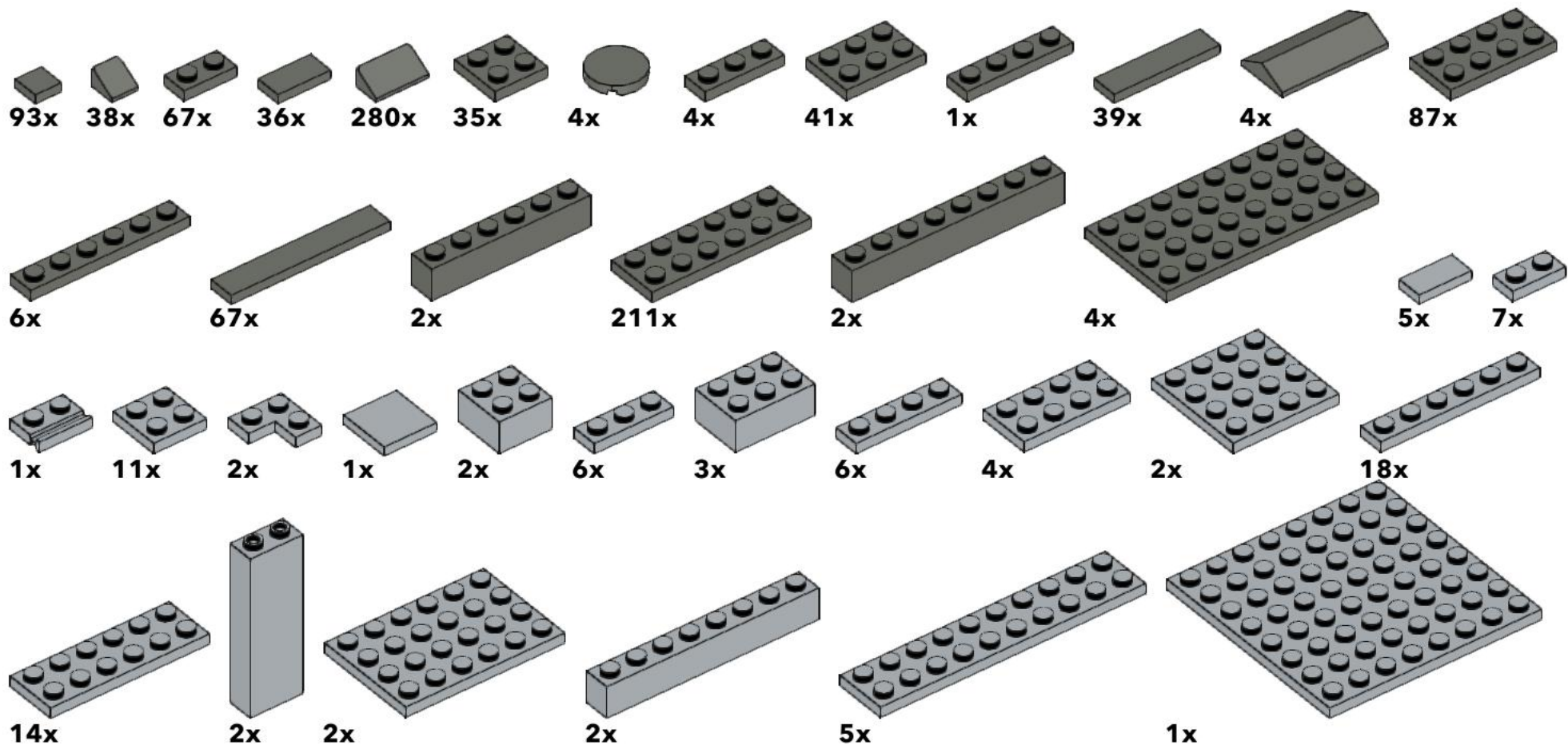

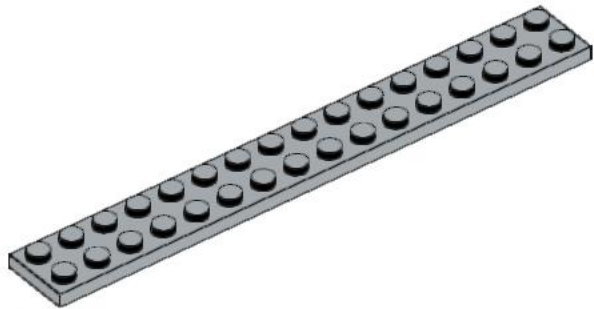

4x

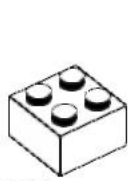
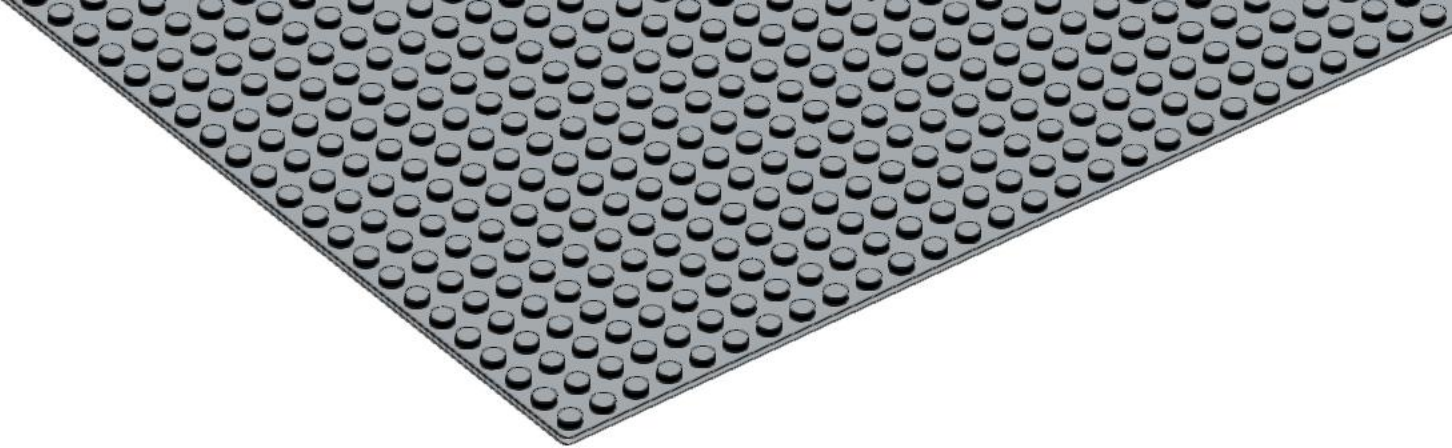

38x

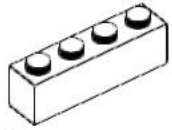

2x

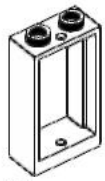

2x

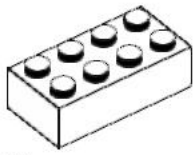

8x

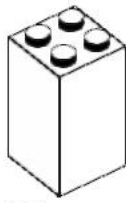

25x

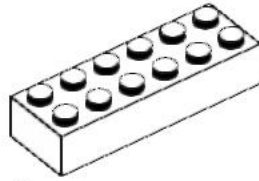

6x



1x



18x



1x

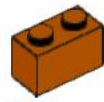

23x



12x

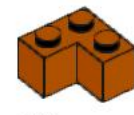

10x



13x

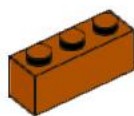

12x

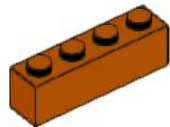

8x

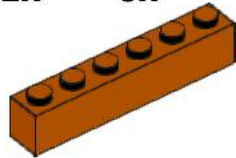

8x



8x



10x



34x

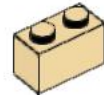

11x



4x

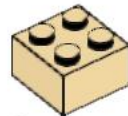

8x

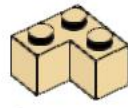

3x



44x

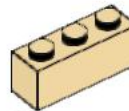

8x

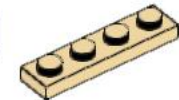

4x

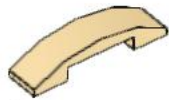

2x

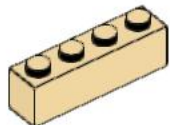

11x



2x

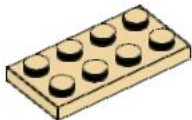

2x

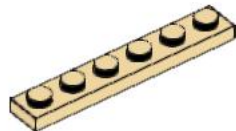

19x

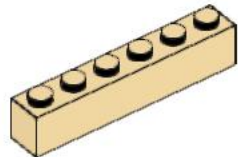

8x

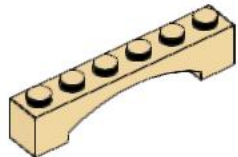

2x

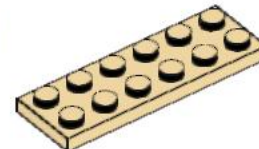

4x

